

Project		Catalog #		Type	
Prepared by		Notes		Date	

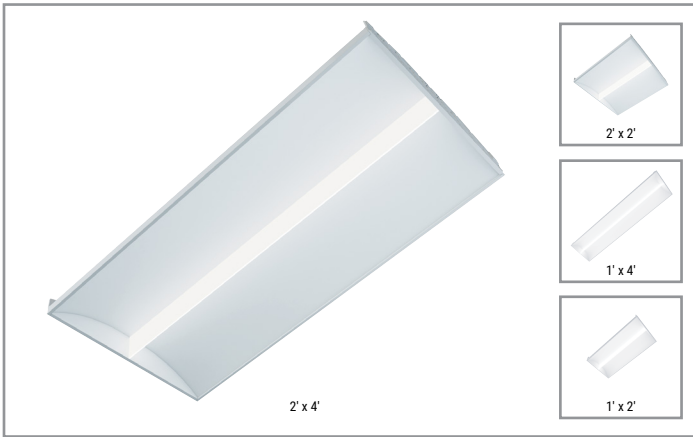

Metalux

SkyRidge LED

1x2 / 1x4 / 2x2 / 2x4 LED Specification
Grade Troffer
LED Module

Typical Applications

- Commercial Office Spaces • Schools • Hospitals • Retail
- Other Indoor Ambient Applications

Product Certification

Notes: (1) 2' x 2' and 2' x 4' only.



Product Features



Interactive Menu

- Order Information [page 2](#)
- Photometric Data [page 4](#)
- Control Solutions [page 9](#)
- Product Warranty

Top Product Features

- Available in 1' x 2', 1' x 4', 2' x 2' and 2' x 4' recessed versions
- Leverages our patented WaveStream Technology with AccuAim™ optics
- Advanced optical control with optimal illumination
- High performance efficacy up to 146 lumens per watt
- Over 60% energy savings when compared to a fluorescent troffers
- Options to meet Buy American and other domestic preference requirements

Dimensional and Mounting Details

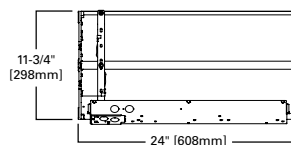
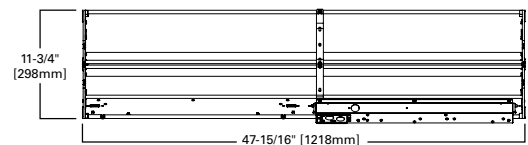
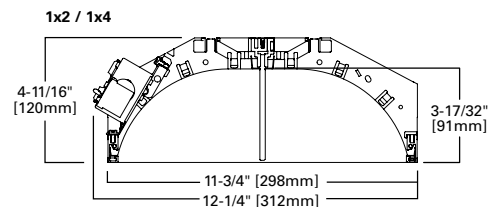
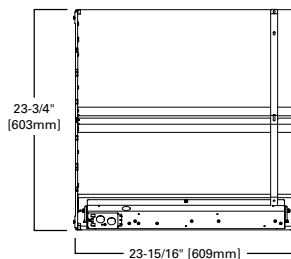
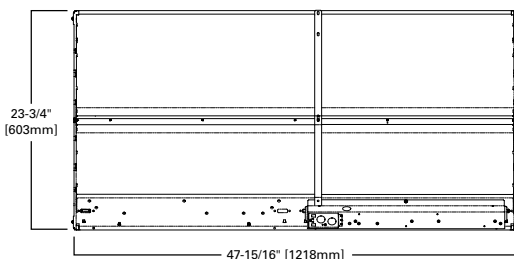
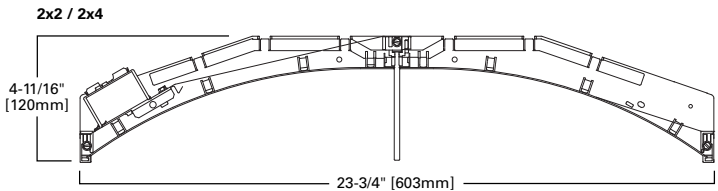

[additional product diagrams](#)

Order Information

SAMPLE ORDER NUMBER: **24SR-LD2-48-C-UNV-L835-CD1-WPN-U**

Domestic Preferences	Rating	Series	Air	Lamp Type	Lumen Outputs			
[Blank] =Standard BAA =Buy American Act TAA =Trade Agreements Act	[Blank] =Standard ATW-SW4 =Chicago Rated ⁽²⁾	24SR =2' x 4' SkyRidge Series 22SR =2' x 2' SkyRidge Series 14SR =1' x 4' SkyRidge Series 12SR =1' x 2' SkyRidge Series	[Blank] =Standard A =Air (Vented) ⁽⁴⁾	LD2 =LED 2.0	2x4 Stock Lumen Outputs 39=3900 Lumens 48=4800 Lumens 2x4 MTO Lumen Outputs 29=2900 Lumens ^{(5), (6)} 34=3400 Lumens ^{(5), (6)} 45=4500 Lumens 53=5300 Lumens 59=5900 Lumens 64=6400 Lumens ⁽⁷⁾	2x2 Stock Lumen Outputs 20=2000 Lumens 29=2900 Lumens 2x2 MTO Lumen Outputs 25=2500 Lumens	1x4 MTO Lumen Outputs 20=2000 Lumens 25=2500 Lumens 30=3000 Lumens 35=3500 Lumens 41=4100 Lumens ^{(8), (9)} 45=4500 Lumens ⁽⁹⁾	1x2 MTO Lumen Outputs 9=900 Lumens 12=1200 Lumens 16=1600 Lumens 20=2000 Lumens 41=4100 Lumens 45=4500 Lumens
Notes ⁽¹⁾ Only product configurations with these designated prefixes are built to be compliant with the Buy American Act of 1933 (BAA) or Trade Agreements Act of 1979 (TAA), respectively. Please refer to DOMESTIC PREFERENCES website for more information. Components shipped separately may be separately analyzed under domestic preference requirements.	Notes ⁽²⁾ Chicago rated version does not allow for row mounting.	Notes ⁽³⁾ DesignLights Consortium® Qualified and classified for DLC Standard, refer to www.designlights.org for details. 12SR and 14SR are not DLC listed	Notes ⁽⁴⁾ Air version is vented but does not meet air handling requirements. Air version is non-IC. Air version is not available with integrated sensor. Air version is not offered for the 12SR.		Notes ⁽⁵⁾ 2900 and 3400 lumen packages are not available with Step-Dim driver. ⁽⁶⁾ 2900 and 3400 lumen packages are not available with 5LTD -Dali option driver. ⁽⁷⁾ 5LTD option uses two drivers at 6400 lumens.		Notes ⁽⁸⁾ Step-dim driver is only available with 4100 and 4500 lumen packages ⁽⁹⁾ Fifth Light (5LTD) driver is only available with 4100 and 4500 lumen packages.	

Reflector	Optics	Voltage	Emergency Options	CCT	Flex
C =Curved (Standard)	[Blank] =Standard	347V =347 Volt UNV =Universal Voltage 120-277V 120V =120 Volt ⁽¹¹⁾ 277V =277 Volt ⁽¹¹⁾	EL7W =7-watt, 120V-277V emergency battery pack installed ⁽¹²⁾ EL14W =14-watt 120V-277V emergency battery pack installed ⁽¹²⁾ ETRD =120-277V Emergency Transfer Relay with dimming control ⁽¹³⁾	L830 =80CRI, 3000K L835 =80CRI, 3500K L840 =80CRI, 4000K L850 =80CRI, 5000K	A3/8-4/18GDIM =3/8" Flex with 0-10V Dimming Leads Multiple other configurations available. See below for details. A3/8-5/18GDIM =Flex with 0-10V Dimming leads and Blue for alternate wiring. See below for details.
		Notes ⁽¹⁰⁾ Products also available in non-US voltages and frequencies for international markets. ⁽¹¹⁾ Must specify voltage as 120V or 277V when ordering GTR2 option.	Notes ⁽¹²⁾ With integral test switch/indicator/laser test. For approximate delivered lumens multiply the lumens per watt of the desired fixture by the wattage of the emergency battery pack (100 lm/W x 7=700 lumens). IES-format photometry for luminaire under emergency operation available. ⁽¹³⁾ Used to bypass local control during outage. Must be used in conjunction with UL 1008 device (provided by others). ETRD option only requires one relay when used on a dimming fixture.		Flexible Metal Conduit Options Flex options available for 0-10V dimming control, DALI dimming control, emergency and night light functions. 72-inch factory-installed and pre-wired to driver, fitted to luminaire housing access plate with 90° enclosed FMC connector. Not all options may be combined and installation ratings vary by type. A3/8-4/18GDIM series notes: Factory installed dimming option 3/8" flexible metal conduit with 2-#18 power and ground wires and 2-#18 UL-listed jacketed 0-10V +/- control wires. Meets UL 66, 83, 1479, 1569, 1581, 2556. NEC® 250.118, 300.22(C), 392, 396, 330, 501, 502, 503, 530, 504, 505, 518, 520, 530, 645, 72; Federal Specification A-A-59544 (formerly J-C-30B); all applicable OSHA and HUD Requirements. UL Classified 1, 2, and 3-hour through penetration with applicable fire stop product (not included). May be surface mounted, fished and/or embedded in plaster. Cable tray and approved raceway rated, install per NEC®; Environmental Air-Handling Space Installation per NEC® 300.22(C).

Driver Type	Number of Drivers	Integrated Sensing Systems	SkyTrim	Packaging	Accessories
CD =0-10V Driver (1%-100% Dimming) 5LTD =DALI Driver (5%-100% Dimming) ⁽¹⁴⁾ 5LTHD =DALI Driver (1%-100% Dimming) ⁽¹⁴⁾ SD =Step Dimming Driver (50%-100% Dimming) ⁽¹⁴⁾ LH =Lutron HiLume (LDE1 series) 1%-100% EcoSystem Driver with Soft-on Fade to Black dimming ⁽⁷⁾ SR =Sensor-ready Driver (1%-100% Dimming)	1=1 Driver	[Blank] =No Sensor WLS (formerly WAB) =WaveLinX LITE Wireless Sensor, Occupancy w/ photocell, Independent & Networked ^{(16), (6)} WPS (formerly WAA) =WaveLinX PRO Wireless Sensor, Occupancy w/ photocell, Networked ^{(17), (A)} WLN =WaveLinX LITE Wireless Control Node, without sensor ^{(18), (6)} WPN =WaveLinX PRO Wireless Control Node, without sensor ^{(17), (A)}	[BLANK] =Standard, No SkyTrim TB =Tahitian Blue PG =Primary Green SO =Storaro Orange PL =Pearl BR =Belladonna Rose MR =Medium Red ST =Straw	U =Unit Pack PALC =Job Pack, in carton	T3A END E.Q. BRACKET PARTS BAG (Standard with fixture) DF-24W-U =2' x 4' Drywall Frame Kit SK-24-WT =2' x 4' Tall Surface Mount Kit
Notes ⁽¹⁴⁾ 2900 and 3400 lumen packages are not available with Step-Dim (SD) driver. Step-dim (SD) driver is only available with 4100 and 4500 lumen packages. ⁽¹⁵⁾ 2900 and 3400 lumen packages are not available with DALI (5LTD) driver. ⁽¹⁶⁾ DALI (5LTHD) option uses two drivers at 6400 lumens. DALI (5LTD) driver is only available with 4100 and 4500 lumen packages. Integrated options must be used in conjunction with the associated system and may not be compatible with other options or accessories. Please refer to the following: (F) Consult Marketplace Options - Lutron system pages for additional details and compatibility. Compatible only with driver series shown, and may require two or more drivers. Requires field commissioning to operate or dim. Contact Lutron at www.lutron.com		Notes ⁽¹⁷⁾ WPS sensor and WPN node to be used with CD or W2A driver. ⁽¹⁸⁾ WLS sensor and WLN node to be used with CD driver. Integrated options must be used in conjunction with the associated system and may not be compatible with other options or accessories. Please refer to the following: (A) Consult WaveLinX PRO system pages for additional details and compatibility. (B) Consult WaveLinX LITE system pages for additional details and compatibility.	Notes ⁽¹⁹⁾ Fixtures using factory installed SkyTrim option are not DLC qualified.		Notes ⁽²⁰⁾ Accessories sold separately will be separately analyzed under domestic preference requirements. Consult factory for further information. Integrated options must be used in conjunction with the associated system and may not be compatible with other options or accessories.

Product Specifications

Construction

- Shallow 4.75" deep housing extruded aluminum frame
- Injected molded composite end plates
- End plates screws for strength, rigidity and gap eliminations
- End plates accessory grid-lock feature adds safety and convenience
- Four auxiliary fixture end suspension points
- Large access plate for supply connection

Controls

- 0-10V dimming to 1% standard
- Integrated WaveLinX options provide wireless individual fixture control and enable code compliance, increased energy savings, grouping of fixtures, and connection to WaveLinX control systems
- DALI 2.0, Lutron, and step-dimming available

Electrical

- LED's available in 3000K, 3500K, 4000K or 5000K with a minimum CRI of 80
- Color accuracy \leq 3-Step MacAdam ellipse (SDCM)
- Projected life is 100,000 hours at 92% lumen output
- Electronic drivers available for 120-277V applications

Emergency Battery Pack Option

- Optional 120V-277V integral emergency battery pack available in 7W
- 90-minute backup period for code compliance
- Test switch with laser pointer allows safe testing from floor
- Patented EZ Key prevents accidental discharge during construction
- Emergency/generated transfer option available (see ordering information for details)

Driver Access

- Drivers can be accessed via plenum

Finish

- High reflectance baked matte white enamel finish for luminous uniformity

Optics

- Precision formed optical assembly
- Positively retained high optical grade acrylic lenses
- WaveStream LED technology provides a distribution

SkyTrim Accessory

- A luminous decorative accent that can be mounted directly on the light guide of a SkyRidge fixture either at the factory or in the field
- Designed for an array of interior applications
- Ideal for spaces where color is necessary to provide visual cues, emphasize brand identity, directional awareness or simply as an artistic expression

Compliance

- Components are UL recognized
- cULus listed for 25° C ambient indoor environments
- RoHS compliant
- Complies with IESNA LM-79
- LEDs compliant with LM-80 standards
- DesignLights Consortium® Qualified and classified for DLC Standard (refer to www.designlights.org)

Warranty

- Five-year limited warranty. Optional ten year limited warranty available.

SkyTrim Options

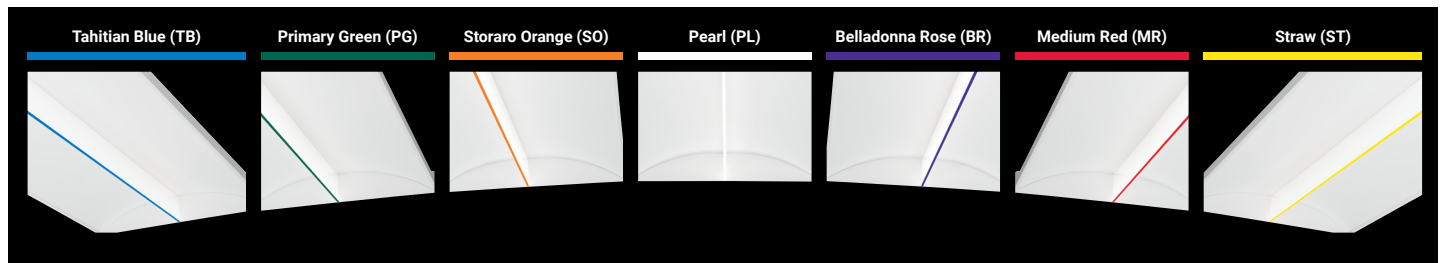

Lamp Configurations

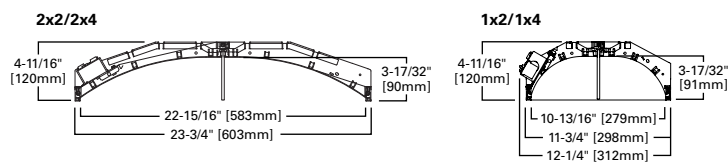

Ceiling Compatibility

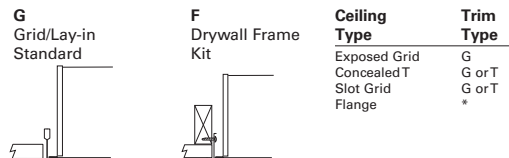

*See Drywall Frame Kit Accessory in Ordering Information section.

**Fixture construction is suitable for use in Air-handling and plenum rated spaces in accordance with Section 300.22 (C) of the National Electrical Code, Section 4.3.11.2.6.5 of NFPA 90A and Section 602.2.1.4 of ICC.

Photometric Data

 [View IES files](#)

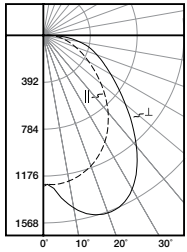

24SR-LD2-39-CUNV-L835-CD1-U
 Electronic Driver
 Linear LED 3500K
 Spacing criterion: (II) 1.18 x mounting height,
 (L) 1.52 x mounting height
 Lumens: 4197
 Input Watts: 31.9W
 Efficacy: 131.6 lm/W
 Test Report: 24SR-LD2-39-CUNV-L835-CD1-U.IES

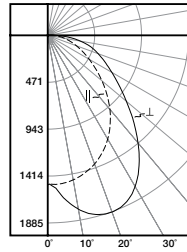

24SR-LD2-48-CUNV-L835-CD1-U
 Electronic Driver
 Linear LED 3500K
 Spacing criterion: (II) 1.18 x mounting height,
 (L) 1.52 x mounting height
 Lumens: 5045
 Input Watts: 38.2W
 Efficacy: 132.1 lm/W
 Test Report: 24SR-LD2-48-C-UNV-L835-CD1-U.IES

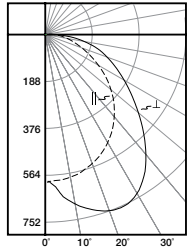

22SR-LD2-20-CUNV-L835-CD1-U
 Electronic Driver
 Linear LED 3500K
 Spacing criterion: (II) 1.22 x mounting height,
 (L) 1.6 x mounting height
 Lumens: 2107
 Input Watts: 15.4W
 Efficacy: 136.8 lm/W
 Test Report: 22SR-LD2-20-CUNV-L835-CD1-U.IES

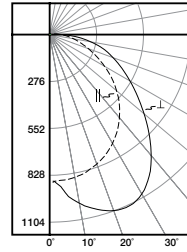

22SR-LD2-29-CUNV-L835-CD1-U
 Electronic Driver
 Linear LED 3500K
 Spacing criterion: (II) 1.22 x mounting height,
 (L) 1.6 x mounting height
 Lumens: 3095
 Input Watts: 23.4W
 Efficacy: 132.3 lm/W
 Test Report: 22SR-LD2-29-CUNV-L835-CD1-U.IES

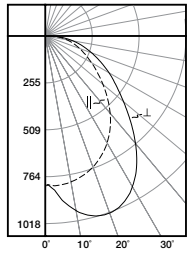

14SR-LD2-25-C-UNV-L835-CD1-U
 Electronic Driver
 Linear LED 3500K
 Spacing criterion: (II) 1.2 x mounting height,
 (L) 1.51 x mounting height
 Lumens: 2636
 Input Watts: 20.9W
 Efficacy: 126.1 lm/W
 Test Report: 14SR-LD2-25-C-UNV-L835-CD1-U.IES

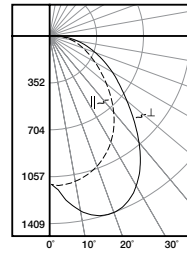

14SR-LD2-35-C-UNV-L835-CD1-U
 Electronic Driver
 Linear LED 3500K
 Spacing criterion: (II) 1.2 x mounting height,
 (L) 1.51 x mounting height
 Lumens: 3647
 Input Watts: 28.4W
 Efficacy: 128.4 lm/W
 Test Report: 14SR-LD2-35-C-UNV-L835-CD1-U.IES

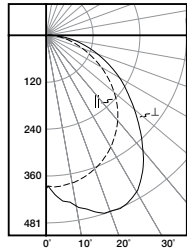

12SR-LD2-12-CUNV-L835-CD1-U
 Electronic Driver
 Linear LED 3500K
 Spacing criterion: (II) 1.25 x mounting height,
 (L) 1.56 x mounting height
 Lumens: 1318
 Input Watts: 9.9W
 Efficacy: 133.1 lm/W
 Test Report: 12SR-LD2-12-CUNV-L835-CD1-U.IES

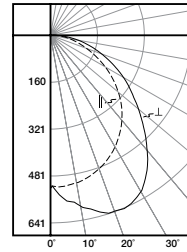

12SR-LD2-16-CUNV-L835-CD1-U
 Electronic Driver
 Linear LED 3500K
 Spacing criterion: (II) 1.25 x mounting height,
 (L) 1.56 x mounting height
 Lumens: 1759
 Input Watts: 13W
 Efficacy: 135.3 lm/W
 Test Report: 12SR-LD2-16-CUNV-L835-CD1-U.IES

2' x 4' Energy and Performance Data by Catalog Number

Stock or MTO	Catalog Logic (Curved)	Delivered Lumens	Watts	Efficacy (LPW)
MTO	24SR-LD2-29-C-UNV-L830-CD1-U	2982	22.7	131
MTO	24SR-LD2-29-C-UNV-L835-CD1-U	3074	22.7	135
MTO	24SR-LD2-29-C-UNV-L840-CD1-U	3136	22.7	138
MTO	24SR-LD2-29-C-UNV-L850-CD1-U	3413	22.7	150
MTO	24SR-LD2-34-C-UNV-L830-CD1-U	3528	27.2	130
MTO	24SR-LD2-34-C-UNV-L835-CD1-U	3637	27.2	134
MTO	24SR-LD2-34-C-UNV-L840-CD1-U	3710	27.2	136
MTO	24SR-LD2-34-C-UNV-L850-CD1-U	4037	27.2	148
MTO	24SR-LD2-39-C-UNV-L830-CD1-U	4071	31.9	128
Stock	24SR-LD2-39-C-UNV-L835-CD1-U	4197	31.9	132
Stock	24SR-LD2-39-C-UNV-L840-CD1-U	4281	31.9	134
MTO	24SR-LD2-39-C-UNV-L850-CD1-U	4659	31.9	146
MTO	24SR-LD2-45-C-UNV-L830-CD1-U	4596	36.7	125
MTO	24SR-LD2-45-C-UNV-L835-CD1-U	4738	36.7	129
MTO	24SR-LD2-45-C-UNV-L840-CD1-U	4832	36.7	132
MTO	24SR-LD2-45-C-UNV-L850-CD1-U	5258	36.7	143
MTO	24SR-LD2-48-C-UNV-L830-CD1-U	4894	38.2	128
Stock	24SR-LD2-48-C-UNV-L835-CD1-U	5045	38.2	132
Stock	24SR-LD2-48-C-UNV-L840-CD1-U	5146	38.2	135
MTO	24SR-LD2-48-C-UNV-L850-CD1-U	5601	38.2	147
MTO	24SR-LD2-53-C-UNV-L830-CD1-U	5416	43.1	126
MTO	24SR-LD2-53-C-UNV-L835-CD1-U	5584	43.1	130
MTO	24SR-LD2-53-C-UNV-L840-CD1-U	5695	43.1	132
MTO	24SR-LD2-53-C-UNV-L850-CD1-U	6198	43.1	144
MTO	24SR-LD2-59-C-UNV-L830-CD1-U	6026	50.2	120
MTO	24SR-LD2-59-C-UNV-L835-CD1-U	6213	50.2	124
MTO	24SR-LD2-59-C-UNV-L840-CD1-U	6337	50.2	126
MTO	24SR-LD2-59-C-UNV-L850-CD1-U	6896	50.2	137
MTO	24SR-LD2-64-C-UNV-L830-CD1-U	6598	55.5	119
MTO	24SR-LD2-64-C-UNV-L835-CD1-U	6802	55.5	123
MTO	24SR-LD2-64-C-UNV-L840-CD1-U	6938	55.5	125
MTO	24SR-LD2-64-C-UNV-L850-CD1-U	7551	55.5	136

Shielding

Lumen Adjustment Factors						
TB	PG	SO	PL	BR	MR	ST
0.683	0.572	0.684	0.935	0.575	0.565	0.885

Note: Average values shown. Refer to IES-format photometry for exact performance data.

Lumen Maintenance (Non-IC Data)

Ambient Temperature	TM-21 Lumen Maintenance (100,000 hours) ⁽¹⁾	Theoretical L70 (Hours) ⁽²⁾
25°C	> 92%	> 448,000

Notes: (1) Supported by IES TM-21 standards. (2) Theoretical values represent estimations commonly used; however, refer to the IES position on LED Product Lifetime Prediction, IES PS-10-18, that explains proper use of IES TM-21 and LM-80.

SkyTrim Field Installation Kits

Color Choice	Kit Catalog Number	Kit Quantity
Tahitian Blue	STK-4-TB-10PK	10
Primary Green	STK-4-PG-10PK	10
Storaro Orange	STK-4-SO-10PK	10
Belladonna Rose	STK-4-BR-10PK	10
Medium Red	STK-4-MR-10PK	10
Pearl	STK-4-PL-10PK	10
Straw	STK-4-ST-10PK	10

Note: Chosen color will be matched on acrylic but will appear lighter once applied to lit light guide.

Shipping Data

Catalog No.	Wt.
24SR-LD2-39	24 lbs.
24SR-LD2-48	24 lbs.

2' x 2' Energy and Performance Data by Catalog Number

Stock or MTO	Catalog Logic (Curved)	Delivered Lumens	Watts	Efficacy (LPW)
MTO	22SR-LD2-20-C-UNV-L830-CD1-U	2044	15.4	133
Stock	22SR-LD2-20-C-UNV-L835-CD1-U	2107	15.4	137
Stock	22SR-LD2-20-C-UNV-L840-CD1-U	2149	15.4	140
MTO	22SR-LD2-20-C-UNV-L850-CD1-U	2339	15.4	152
MTO	22SR-LD2-25-C-UNV-L830-CD1-U	2571	19.6	131
MTO	22SR-LD2-25-C-UNV-L835-CD1-U	2651	19.6	135
MTO	22SR-LD2-25-C-UNV-L840-CD1-U	2705	19.6	138
MTO	22SR-LD2-25-C-UNV-L850-CD1-U	2943	19.6	150
MTO	22SR-LD2-29-C-UNV-L830-CD1-U	3003	23.4	128
Stock	22SR-LD2-29-C-UNV-L835-CD1-U	3095	23.4	132
Stock	22SR-LD2-29-C-UNV-L840-CD1-U	3157	23.4	135
MTO	22SR-LD2-29-C-UNV-L850-CD1-U	3436	23.4	147

Shielding

Lumen Adjustment Factors						
TB	PG	SO	PL	BR	MR	ST
0.640	0.592	0.701	0.868	0.582	0.586	0.932

Note: Average values shown. Refer to IES-format photometry for exact performance data.

Lumen Maintenance

Ambient Temperature	TM-21 Lumen Maintenance (100,000 hours) ⁽¹⁾	Theoretical L70 (Hours) ⁽²⁾
25°C	> 92%	> 448,000

Notes: (1) Supported by IES TM-21 standards. (2) Theoretical values represent estimations commonly used; however, refer to the IES position on LED Product Lifetime Prediction, IES PS-10-18, that explains proper use of IES TM-21 and LM-80.

Shipping Data

Catalog No.	Wt.
22SR-LD2-20	12 lbs.
22SR-LD2-29	12 lbs.

SkyTrim Field Installation Kits

Color Choice	Kit Catalog Number	Kit Quantity
Tahitian Blue	STK-2-TB-10PK	10
Primary Green	STK-2-PG-10PK	10
Storaro Orange	STK-2-SO-10PK	10
Belladonna Rose	STK-2-BR-10PK	10
Medium Red	STK-2-MR-10PK	10
Pearl	STK-2-PL-10PK	10
Straw	STK-2-ST-10PK	10

Note: Chosen color will be matched on acrylic but will appear lighter once applied to lit light guide.

1' x 4' Energy and Performance Data by Catalog Number

Stock or MTO	Catalog Logic (Curved)	Delivered Lumens	Watts	Efficacy (lm/W)
MTO	14SR-LD2-20-C-UNV-L830-CD1-U	2107	16.4	128
MTO	14SR-LD2-20-C-UNV-L835-CD1-U	2172	16.4	132
MTO	14SR-LD2-20-C-UNV-L840-CD1-U	2216	16.4	135
MTO	14SR-LD2-20-C-UNV-L850-CD1-U	2412	16.4	147
MTO	14SR-LD2-25-C-UNV-L830-CD1-U	2557	20.9	122
MTO	14SR-LD2-25-C-UNV-L835-CD1-U	2636	20.9	126
MTO	14SR-LD2-25-C-UNV-L840-CD1-U	2688	20.9	129
MTO	14SR-LD2-25-C-UNV-L850-CD1-U	2925	20.9	140
MTO	14SR-LD2-30-C-UNV-L830-CD1-U	3102	24.5	127
MTO	14SR-LD2-30-C-UNV-L835-CD1-U	3197	24.5	131
MTO	14SR-LD2-30-C-UNV-L840-CD1-U	3261	24.5	133
MTO	14SR-LD2-30-C-UNV-L850-CD1-U	3549	24.5	145
MTO	14SR-LD2-35-C-UNV-L830-CD1-U	3537	28.4	125
MTO	14SR-LD2-35-C-UNV-L835-CD1-U	3647	28.4	128
MTO	14SR-LD2-35-C-UNV-L840-CD1-U	3719	28.4	131
MTO	14SR-LD2-35-C-UNV-L850-CD1-U	4048	28.4	143
MTO	14SR-LD2-41-C-UNV-L830-CD1-U	4155	34.0	122
MTO	14SR-LD2-41-C-UNV-L835-CD1-U	4283	34.0	126
MTO	14SR-LD2-41-C-UNV-L840-CD1-U	4369	34.0	129
MTO	14SR-LD2-41-C-UNV-L850-CD1-U	4754	34.0	140
MTO	14SR-LD2-45-C-UNV-L830-CD1-U	4557	37.9	120
MTO	14SR-LD2-45-C-UNV-L835-CD1-U	4698	37.9	124
MTO	14SR-LD2-45-C-UNV-L840-CD1-U	4791	37.9	126
MTO	14SR-LD2-45-C-UNV-L850-CD1-U	5214	37.9	138

Shielding

Lumen Adjustment Factors						
TB	PG	SO	PL	BR	MR	ST
0.683	0.572	0.684	0.935	0.575	0.565	0.885

Note: Average values shown. Refer to IES-format photometry for exact performance data.

Lumen Maintenance

Ambient Temperature	TM-21 Lumen Maintenance (100,000 hours) ⁽¹⁾	Theoretical L70 (Hours) ⁽²⁾
25°C	> 92%	> 448,000

Non-IC data

Notes: (1) Supported by IES TM-21 standards. (2) Theoretical values represent estimations commonly used; however, refer to the IES position on LED Product Lifetime Prediction, IES PS-10-18, that explains proper use of IES TM-21 and LM-80.

Shipping Data

Catalog No.	Wt.
14SR-LD2-12	18 lbs.

SkyTrim Field Installation Kits

Color Choice	Kit Catalog Number	Kit Quantity
Tahitian Blue	STK-4-TB-10PK	10
Primary Green	STK-4-PG-10PK	10
Storaro Orange	STK-4-SO-10PK	10
Belladonna Rose	STK-4-BR-10PK	10
Medium Red	STK-4-MR-10PK	10
Pearl	STK-4-PL-10PK	10
Straw	STK-4-ST-10PK	10

Note: Chosen color will be matched on acrylic but will appear lighter once applied to lit light guide.

1' x 2' Energy and Performance Data by Catalog Number

Stock or MTO	Catalog Logic (Curved)	Delivered Lumens	Watts	Efficacy (lm/W)
MTO	12SR-LD2-9-C-UNV-L830-CD1-U	944	9.1	104
MTO	12SR-LD2-9-C-UNV-L835-CD1-U	973	9.1	107
MTO	12SR-LD2-9-C-UNV-L840-CD1-U	993	9.1	109
MTO	12SR-LD2-9-C-UNV-L850-CD1-U	1080	9.1	119
MTO	12SR-LD2-12-C-UNV-L830-CD1-U	1278	9.9	129
MTO	12SR-LD2-12-C-UNV-L835-CD1-U	1318	9.9	133
MTO	12SR-LD2-12-C-UNV-L840-CD1-U	1344	9.9	136
MTO	12SR-LD2-12-C-UNV-L850-CD1-U	1463	9.9	148
MTO	12SR-LD2-16-C-UNV-L830-CD1-U	1706	13.0	131
MTO	12SR-LD2-16-C-UNV-L835-CD1-U	1759	13.0	135
MTO	12SR-LD2-16-C-UNV-L840-CD1-U	1794	13.0	138
MTO	12SR-LD2-16-C-UNV-L850-CD1-U	1952	13.0	150
MTO	12SR-LD2-20-C-UNV-L830-CD1-U	2120	16.3	130
MTO	12SR-LD2-20-C-UNV-L835-CD1-U	2185	16.3	134
MTO	12SR-LD2-20-C-UNV-L840-CD1-U	2229	16.3	137
MTO	12SR-LD2-20-C-UNV-L850-CD1-U	2426	16.3	149

SkyTrim Field Installation Kits

Color Choice	Kit Catalog Number	Kit Quantity
Tahitian Blue	STK-2-TB-10PK	10
Primary Green	STK-2-PG-10PK	10
Storaro Orange	STK-2-SO-10PK	10
Belladonna Rose	STK-2-BR-10PK	10
Medium Red	STK-2-MR-10PK	10
Pearl	STK-2-PL-10PK	10
Straw	STK-2-ST-10PK	10

Note: Chosen color will be matched on acrylic but will appear lighter once applied to lit light guide.

Lumen Maintenance

Ambient Temperature	TM-21 Lumen Maintenance (100,000 hours) ⁽¹⁾	Theoretical L70 (Hours) ⁽²⁾
25°C	> 92%	> 130,000

Notes: (1) Supported by IES TM-21 standards. (2) Theoretical values represent estimations commonly used; however, refer to the IES position on LED Product Lifetime Prediction, IES PS-10-18, that explains proper use of IES TM-21 and LM-80.

Shipping Data

Catalog No.	Wt.
12SR-LD2-12	8 lbs.

Shielding

Lumen Adjustment Factors						
TB	PG	SO	PL	BR	MR	ST
0.640	0.592	0.701	0.868	0.582	0.586	0.932

Note: Average values shown. Refer to IES-format photometry for exact performance data.

Control Solutions

- WaveLinX LITE wireless
- WaveLinX PRO wireless
- WaveLinX CAT wired
- WaveLinX Wired



The SkyRidge with WaveLinX offers no-hassle lighting control with multiple luminaire level control solutions.



WaveLinX PRO is a wireless lighting control solution, for connected spaces, that significantly reduces a building's energy consumption. From a single floor to an entire campus, WaveLinX PRO connects more than lighting assets; it shares aggregated sensor data with the WaveLinX CORE platform and other building systems, so building owners can improve operations, spaces environment, and tenants' experience. WaveLinX PRO offers a rich portfolio of wireless devices, WaveLinX PRO-enabled luminaires, and an intuitive WaveLinX mobile app for office, education, warehouse, and parking garage applications.



WaveLinX LITE is a cost effective, wireless digital lighting control solution, with out-of-the-box functionality, that saves energy and meets code. It's designed for applications that require occupancy-based, daylighting, or manual light control. Customize installations for office, education, warehouse and parking garages using the secure, simple mobile app.

Integrated Sensor Coverage Pattern

TOP VIEW:

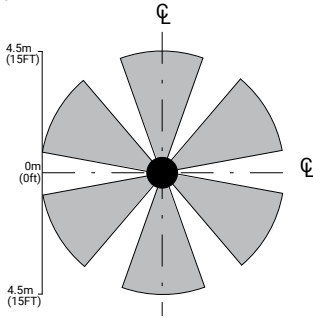

SIDE VIEW:

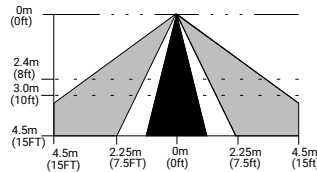

Note: Installation of integrated sensors within 3-ft (1m) of HVAC air vents is not recommended. The pattern shown is intended solely as a general guide and is not to scale.

With Integrated WaveLinX Sensor

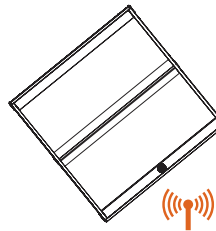

With Integrated WaveLinX Node

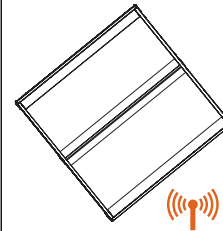

Add a hidden WaveLinX sensor node (WPN, WLN) to your space lighting design!

Allows to:

- Keeps luminaire aesthetics
- Connect fixtures without the realestate to include sensor option such as downlights
- Connect sealed fixtures without a standard sensor option such as products for clinical space.

Integrated Controls Options

Option	Out of the Box Functionality	Luminaire Level Lighting Control (LLC)	Automatic Dimming Photocell	Occupancy Sensing	CCT Control
WLS	X	X	X	X	
WLN		X			
WPS		X	X	X	X
WPN		X			X

Note: WaveLinX utilizes scenes to allow users to change an area's fixtures Correlated Color Temperature (CCT) and intensity using commissioned manual wireless wallstation scene control. To enable CCT adjustments through WaveLinX, include WPS or WPN devices in addition to VividTune or BioUp technologies for integrated fixture control.

Systems comparison chart

Cooper Lighting Solutions provides many lighting system solutions designed to satisfy code requirements and meet the unique needs of any project.



Luminaire with standalone sensor

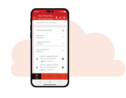

Standalone Spaces WaveLinX LITE



Standalone Spaces WaveLinX CAT



Networked Spaces WaveLinX PRO



Enterprise WaveLinX CORE

	Luminaire with standalone sensor	Standalone Spaces WaveLinX LITE	Standalone Spaces WaveLinX CAT	Networked Spaces WaveLinX PRO	Enterprise WaveLinX CORE
Occupancy	Yes	Yes	Yes	Yes	Yes
Daylighting	Yes	Yes	Yes	Yes	Yes
Wallstations	-	Yes	Yes	Yes	Yes
Gateways	-	-	-	1 WAC	300 WACs
Devices (MAX)	-	40 per Area (1120 per space)	40 per Area	200 per WAC2	32,500 per CORE Enterprise
Software	-	WaveLinX LITE Mobile App	WaveLinX CAT Mobile App	WaveLinX Mobile App	CORE
Areas	-	28 per Space	Unlimited	50 per WAC2	up to 3,000
Zones	-	16 per Area	16 per Area	16 per Area	up to 9,000
Scheduling	-	-	-	Local	Global
VividTune™	-	-	-	Yes	Yes
Plug-Load Control	-	Yes	Yes	Yes	Yes
Low-Voltage Power	-	-	Yes	Yes	Yes
Integration	-	-	-	-	BACnet, API
Dashboards	-	-	-	-	Energy, Occupancy
Configuration	-	Installer	Installer	Technician	Technician / IT