

Project		Catalog #		Type	
Prepared by		Notes		Date	



Metalux

4WSL / 8WSL

4 ft. and 8 ft. Linear Wavestream LED
Commercial Grade Linear

Typical Applications

Office • Education • Hospitality • Reception • Retail • Hallways

Interactive Menu

- Order Information [page 2](#)
- Photometric Data [page 3](#)
- Control Solutions [page 6](#)
- Product Warranty

Product Certification



Product Features



Top Product Features

- 4 ft. and 8 ft. configuration
- Robust aluminum and steel housing measuring less than 3.2" in depth
- Wavestream technology with Accu-Aim optics
- High efficiencies ranging up to 124 IPW
- UNV, 0 to 10V dimmable driver (standard), with option step-dim & DALI
- Options to meet Trade Agreements Act requirements

Dimensional Details

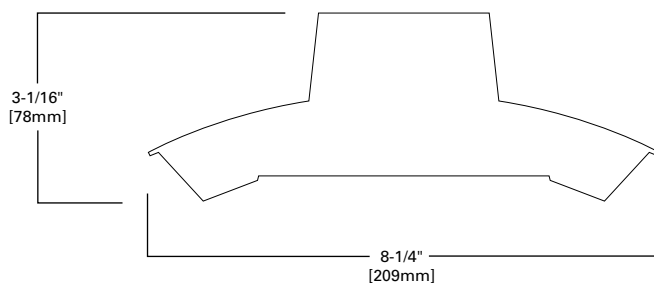

[additional product diagrams](#)

Order Information

SAMPLE ORDER NUMBER: **4WSL-LD2-80-SRC-UNV-L840-CD1-U**

Domestic Preferences	Series	Revision	Lumen Output		Application	Uplight	Voltage	Emergency Options
[Blank] =Standard TAA =Trade Agreements Act	4WSL =4 ft. 8WSL =8 ft.	LD2 =LED 2.0	4 ft. 30=3000 35=3500 40=4000 45=4500 50=5000 55=5500 60=6000 65=6500 70=7000 75=7500 80=8000	8 ft. 60=6000 65=6500 70=7000 75=7500 80=8000 90=9000 100=10000 110=11000 120=12000 130=13000 140=14000 150=15000 160=16000	SRS =Surface – Standalone SRC =Surface – Continuous Row ⁽³⁾ SPS =Suspended – Standalone SPC =Suspended – Continuous Row ⁽³⁾	[Blank] =Downlight Only UPL8 =8% Uplight UPL15 =15% Uplight	347 =347 Volt ⁽⁴⁾ 480 =480 Volt UNV =Universal Voltage 120-277	EL7W =7-watt, 120V-277V emergency battery pack installed ⁽⁵⁾ EL14W =14-watt, 120V-277V emergency battery pack installed ⁽⁵⁾ GTR2 =Bodine Generator Transfer Relay ⁽⁶⁾ ETRD =Emergency Transfer Relay with dimming control ⁽⁶⁾
Notes (1) Only product configurations with this designated prefix are built to be compliant with the Trade Agreements Act of 1979 (TAA). Please refer to DOMESTIC PREFERENCES website for more information. Components shipped separately may be separately analyzed under domestic preference requirements.	Notes (2) DesignLights Consortium® Qualified and classified for DLC Standard (all lumen packages), refer to www.designlights.org for details.				Notes (3) Continuous row version comes with one end cap and one row trim finishing component.		Notes (4) 347V emergency option not available in 4 ft.	Notes (5) With integral test switch/indicator/laser test. For approximate delivered lumens multiply the lumens per watt of the desired fixture by the wattage of the emergency battery pack (100 lm/W x 7=700 lumens). IES-format photometry for luminaire under emergency operation available. (6) Used to bypass local control during outage. Must be used in conjunction with UL 1008 device (provided by others). GTR2 option includes 2 relays on fixtures with dimming drivers. ETRD option only requires one relay when used on a dimming fixture. Must specify voltage as 120V or 277V when ordering these devices.

Color Temperature	Driver Type	Number of Drivers	Options
L835 =80CRI, 3500K L840 =80CRI, 4000K L850 =80CRI, 5000K	CD =0-10V Dimming Driver (1%-100% Dimming) SR =Sensor-ready Dimming Driver (1%-100% Dimming) 5LTD =Fifth Light DALI Driver (10%-100% Dimming) ^(E) 5LTHD =Fifth Light Dimming Driver (1%-100% Dimming) ^{(7), (E)} SD =Step Dimming Driver (50% or 100% Dimming) ⁽⁷⁾ LH =Lutron HiLume (LDE1 series) 1%-100% EcoSystem Driver with Soft-on Fade to Black dimming ^(F)	1 =1 Driver 2 =2 Drivers	XFMR =Step Down Transformer Flex ⁽⁸⁾ Multiple Configurations Available Wiring PI =Plug-in Option ⁽⁹⁾ CPI =Crossover Plug-in Option ⁽⁹⁾
	Notes (7) Two Drivers required for 5,500 to 10,000 lm and three drivers required for 11,000 to 16,000 lm. Integrated options must be used in conjunction with the associated system and may not be compatible with other options or accessories. Please refer to the following: (E) Consult Fifth Light system pages for additional details and compatibility. (F) Consult Marketplace Options - Lutron system pages for additional details and compatibility. Compatible only with driver series shown, and may require two or more drivers. Requires field commissioning to operate or dim. Contact Lutron at www.lutron.com .		Notes (8) Flex does not include dimming leads. Control leads provided by others. For Surface mount versions only, Flex must be ordered as a separate accessory. (9) For more information on PI and CPI options, please refer to WSL FAQ Guide at www.cooperlighting.com

Integrated Sensing Systems	Packaging	Accessories
[Blank] =No Sensor WLS (formerly WAB) =WaveLinX LITE Wireless Sensor, Occupancy w/ photocell, Independent & Networked ^{(11), (B)} WPS (formerly WAA) =WaveLinX PRO Wireless Sensor, Occupancy w/ photocell, Networked ^{(10), (A)}	U =Unit Pack	CLC-WSL-EXT-B =Channel Connector EndFeed-WSL-U =End Feed Conduit Connector GRP-SNF-U =Gripper Hanger AYC-Chain/Set =36" Chain Hanger SCF =Fixed Stem Set (Specify Length) SCS =Swivel Stem Set (Specify Length) CCA =Adjustable Cable Kit (Specify Length) CCF =Fixed Length Cable Kit (Specify Length) EYE CHAIN SET/3FT =Eye Bolt Chain (Use 1 set per fixture) A1B/Spacer-U =Spacer 1-1/2" to 2-1/2" from ceiling (Use 2 per fixture) TOGGLE =Single Toggle No. 2 (Specify Length) Y-TOGGLE-__-2PK =(2) Y-Toggle Cable Kits (Specify 10 or 30 for length in feet) ⁽¹²⁾ ATG-4-U =Tong Hanger Kit (one for 4 ft, two for 8 ft)
Notes (10) WPS sensor to be used with CD or W2A driver. (11) WLS sensor to be used with CD driver. Integrated options must be used in conjunction with the associated system and may not be compatible with other options or accessories. Please refer to the following: (A) Consult WaveLinX PRO system pages for additional details and compatibility. (B) Consult WaveLinX LITE system pages for additional details and compatibility.		Notes (12) Y-Toggle would apply for stand alone and end of continuous row only. (13) Accessories sold separately will be separately analyzed under domestic preference requirements. Consult factory for further information.

Product Specifications

Applications

- Compatible with all types of mounting options whether stand alone or continuous row
- Flexibility provides options in a wide variety of applications

Construction

- Low profile design - 3" in deep housing
- Housing combines both aluminum extruded frame and steel channel housing
- End plates are securely attached with positive capture details which offer both strength and rigidity while elimination of gaps
- Multiple suspension points are located in the channel which allow for aircraft cable, hanging chain and stem points
- Surface mounting can be achieved through either direct mount via channel or offset by easy-mount tong hanging accessories

Controls

- 0-10V dimming drivers to 1% standard
- WaveLinX wireless sensor compatible for standalone, controlled, connected, and IoT capability
- DALI 2.0, Lutron, and step-dimming available

Electrical

- Long-life LED system with electrical driver for optimal performance
- LED's available in 3500K, 4000K or 5000K with a minimum CRI of 80. Consult factory for 3000K CCT.
- Projected lumen maintenance based on TM21 testing standards is >L81 @60,000 hours
- Electronic drivers available for 120-277V applications

Emergency Battery Pack Option

- Optional 120-277V emergency battery available in 7W or 14W
- 90-minute backup period for code compliance
- Constant power to LED system for controlled, predictable discharge
- Integrated test switch/indicator light installed on fixture
- Integral emergency transfer relay available for generator equipped power systems

Driver Access

- Drivers can be accessed via plenum

Finish

- Durable frame has high reflectance baked matte white enamel finish for luminous uniformity

Mounting / Linear Run

- WSL has the ability to be either surface or suspended and offers both single or continuous row linear run installation flexibility

Optic

- Precision formed optical assembly
- Positively retained high optical grade acrylic lenses
- WaveStream LED technology provides a directed optical distribution

Compliance

- Components are UL recognized
- cULus and CSA listed for 25° C ambient environments
- RoHS compliant
- Complies with IESNA LM-79
- LEDs compliant with LM-80 standards
- DesignLights Consortium® Qualified and classified for DLC Standard (refer to www.designlights.org)

Warranty

- Five year limited warranty standard

Photometric Data

 [View IES files](#)

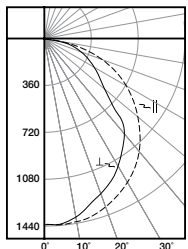

4WSL-LD2-40-UNV-L840- CD1-U

Electronic Driver
 Linear LED 4000K
 Spacing criterion: (||) 1.3 x mounting height,
 (⊥) 1.2 x mounting height
 Lumens: 4010
 Input Watts: 35.1W
 Efficacy: 114 lm/W
 Test Report: 4WSL-LD2-40-UNV-L840-CD1-U.IES

Energy and Performance Data by Catalog Number

MTO	Length	Catalog Number**	Product Description	Delivered Lumens	Input Watts	Efficacy (lm/W)
MTO	4 ft.	4WSL-LD2-30-SXX-UNV-L8XX-CD1-U	4 ft. Wavestream Linear, 3000 lm	3023	24.9	121
MTO	4 ft.	4WSL-LD2-35-SXX-UNV-L8XX-CD1-U	4 ft. Wavestream Linear, 3500 lm	3544	30.6	116
MTO	4 ft.	4WSL-LD2-40-SXX-UNV-L8XX-CD1-U	4 ft. Wavestream Linear, 4000 lm	4010	35.1	114
MTO	4 ft.	4WSL-LD2-45-SXX-UNV-L8XX-CD1-U	4 ft. Wavestream Linear, 4500 lm	4502	39.9	113
MTO	4 ft.	4WSL-LD2-50-SXX-UNV-L8XX-CD1-U	4 ft. Wavestream Linear, 5000 lm	4988	44.8	111
MTO	4 ft.	4WSL-LD2-55-SXX-UNV-L8XX-CD1-U	4 ft. Wavestream Linear, 5500 lm	5541	49.9	111
MTO	4 ft.	4WSL-LD2-60-SXX-UNV-L8XX-CD1-U	4 ft. Wavestream Linear, 6000 lm	5988	56.2	107
MTO	4 ft.	4WSL-LD2-65-SXX-UNV-L8XX-CD1-U	4 ft. Wavestream Linear, 6500 lm	6591	61.9	106
MTO	4 ft.	4WSL-LD2-70-SXX-UNV-L8XX-CD1-U	4 ft. Wavestream Linear, 7000 lm	7005	68.7	102
MTO	4 ft.	4WSL-LD2-75-SXX-UNV-L8XX-CD1-U	4 ft. Wavestream Linear, 7500 lm	7623	73.9	103
MTO	4 ft.	4WSL-LD2-80-SXX-UNV-L8XX-CD1-U	4 ft. Wavestream Linear, 8000 lm	7806	76	103
MTO	8 ft.	8WSL-LD2-60-SXX-UNV-L8XX-CD1-U	8 ft. Wavestream Linear, 6000 lm	6128	53.5	115
MTO	8 ft.	8WSL-LD2-65-SXX-UNV-L8XX-CD1-U	8 ft. Wavestream Linear, 6500 lm	6536	57.6	113
MTO	8 ft.	8WSL-LD2-70-SXX-UNV-L8XX-CD1-U	8 ft. Wavestream Linear, 7000 lm	6934	63.6	109
MTO	8 ft.	8WSL-LD2-75-SXX-UNV-L8XX-CD1-U	8 ft. Wavestream Linear, 7500 lm	7468	67.2	111
MTO	8 ft.	8WSL-LD2-80-SXX-UNV-L8XX-CD1-U	8 ft. Wavestream Linear, 8000 lm	8072	73.1	110
MTO	8 ft.	8WSL-LD2-90-SXX-UNV-L8XX-CD2-U	8 ft. Wavestream Linear, 9000 lm	9004	80.6	112
MTO	8 ft.	8WSL-LD2-100-SXX-UNV-L8XX-CD2-U	8 ft. Wavestream Linear, 10000 lm	9976	90.6	110
MTO	8 ft.	8WSL-LD2-110-SXX-UNV-L8XX-CD2-U	8 ft. Wavestream Linear, 11000 lm	11082	98.9	112
MTO	8 ft.	8WSL-LD2-120-SXX-UNV-L8XX-CD2-U	8 ft. Wavestream Linear, 12000 lm	11976	113.5	106
MTO	8 ft.	8WSL-LD2-130-SXX-UNV-L8XX-CD2-U	8 ft. Wavestream Linear, 13000 lm	13182	124.7	106
MTO	8 ft.	8WSL-LD2-140-SXX-UNV-L8XX-CD2-U	8 ft. Wavestream Linear, 14000 lm	14010	136.6	103
MTO	8 ft.	8WSL-LD2-150-SXX-UNV-L8XX-CD2-U	8 ft. Wavestream Linear, 15000 lm	15246	148.7	103
MTO	8 ft.	8WSL-LD2-160-SXX-UNV-L8XX-CD2-U	8 ft. Wavestream Linear, 16000 lm	15612	152.9	102

* Available in 3500K, 4000K and 5000K

** Shown with solid top reflector. Available with uplight UPL8 (8%) and UPL15 (15%).

SXX denotes mounting option. See ordering information.

Stock	Length	Catalog Number **	Product Description	Delivered Lumens	Input Watts	Efficacy (lm/W)
Stock	4 ft.	4WSL-LD2-40-SRS-UNV-L835-CD1-U	4 ft. Wavestream Linear, 4000 lm, 3500K	4010	35.1	114
Stock	4 ft.	4WSL-LD2-40-SRS-UNV-L840-CD1-U	4 ft. Wavestream Linear, 4000 lm, 4000K	4010	35.1	114
Stock	8 ft.	8WSL-LD2-80-SRS-UNV-L835-CD1-U	8 ft. Wavestream Linear, 8000 lm, 3500K	8072	73.1	110
Stock	8 ft.	8WSL-LD2-80-SRS-UNV-L840-CD1-U	8 ft. Wavestream Linear, 8000 lm, 4000K	8072	73.1	110

** Shown with solid top reflector. Available with uplight UPL8 (8%) and UPL15 (15%).

Lumen Maintenance

Ambient Temperature	TM-21 Lumen Maintenance (60,000 hours)	Theoretical L70 (Hours)
25°C	> 81%	> 100,000

Shipping Data

Catalog No.	Wt.*
4WSL	12 lbs.
8WSL	24 lbs.

* Standard fixture

Dimensional and Mounting Details

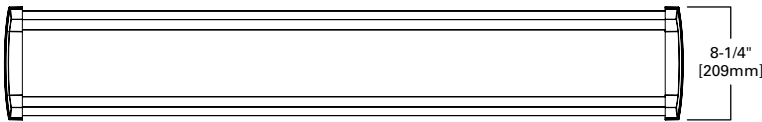
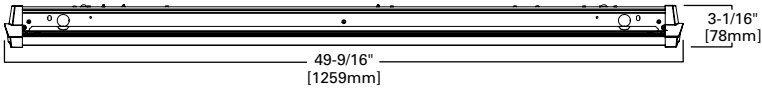
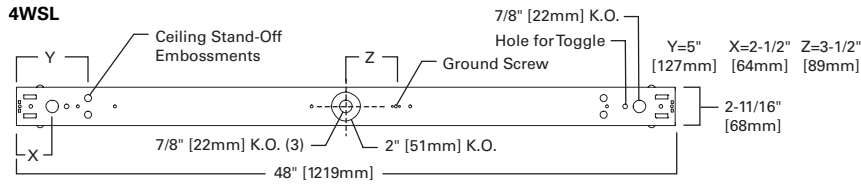

4WSL WITH SENSOR

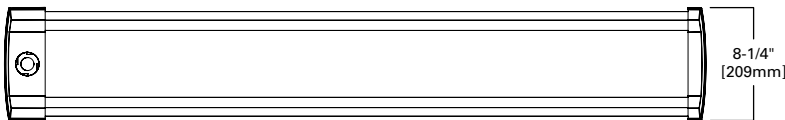
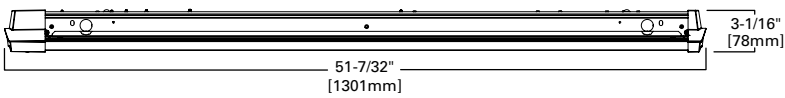

8WSL

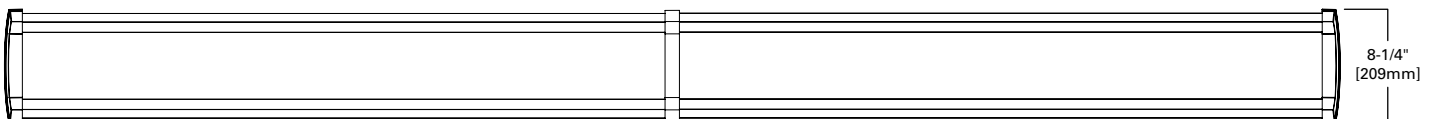
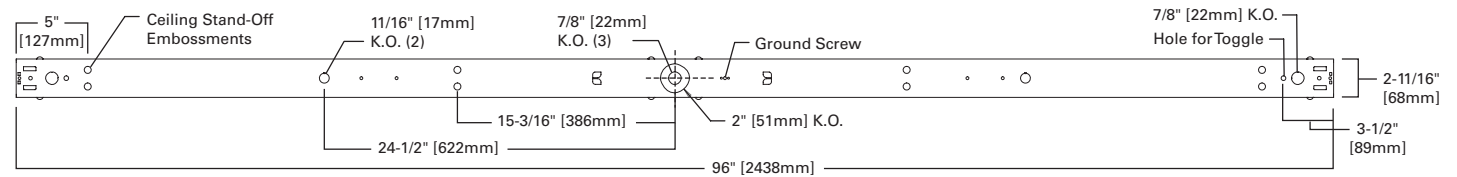

8WSL WITH SENSOR

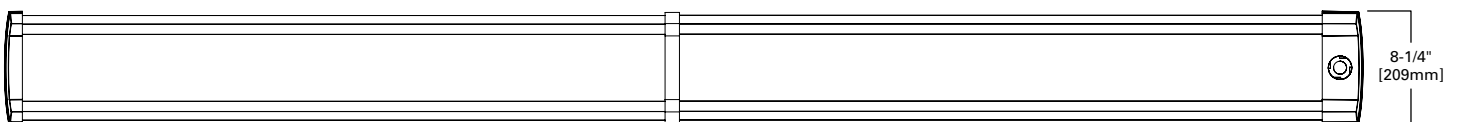
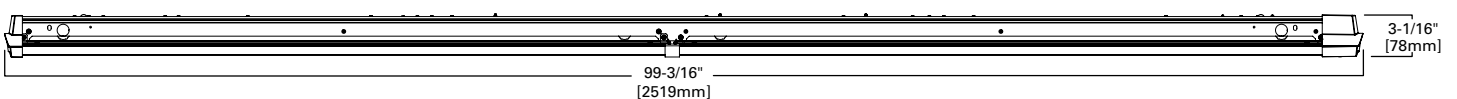

Control Solutions

- WaveLinx LITE wireless
- WaveLinx PRO wireless
- WaveLinx CAT wired
- WaveLinx Wired



The WSL with WaveLinx offers no-hassle lighting control with multiple luminaire level control solutions.



WaveLinx PRO is a wireless lighting control solution, for connected spaces, that significantly reduces a building's energy consumption. From a single floor to an entire campus, WaveLinx PRO connects more than lighting assets; it shares aggregated sensor data with the WaveLinx CORE platform and other building systems, so building owners can improve operations, spaces environment, and tenants' experience. WaveLinx PRO offers a rich portfolio of wireless devices, WaveLinx PRO-enabled luminaires, and an intuitive WaveLinx mobile app for office, education, warehouse, and parking garage applications.



WaveLinx LITE is a cost effective, wireless digital lighting control solution, with out-of-the-box functionality, that saves energy and meets code. It's designed for applications that require occupancy-based, daylighting, or manual light control. Customize installations for office, education, warehouse and parking garages using the secure, simple mobile app.

Integrated Sensor Coverage Pattern

TOP VIEW:

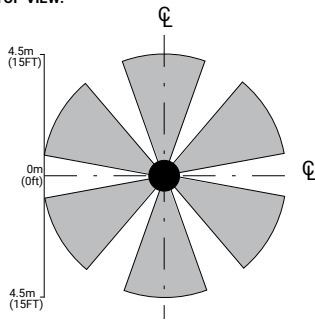

SIDE VIEW:

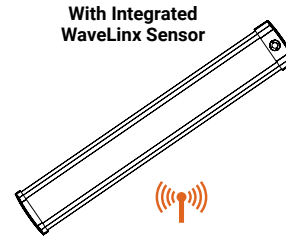
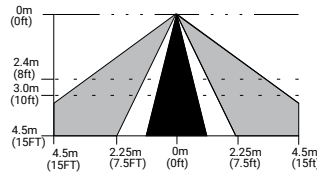

Note: Installation of integrated sensors within 3-ft (1m) of HVAC air vents is not recommended. The pattern shown is intended solely as a general guide and is not to scale.

Integrated Controls Options

Option	Out of the Box Functionality	Luminaire Level Lighting Control (LLC)	Automatic Dimming Photocell	Occupancy Sensing	CCT Control
WLS	X	X	X	X	
WPS		X	X	X	X

Note: WaveLinx utilizes scenes to allow users to change an area's fixtures Correlated Color Temperature (CCT) and intensity using commissioned manual wireless wallstation scene control. To enable CCT adjustments through WaveLinx, include WPS device in addition to VividTune or BioP technologies for integrated fixture control.

Systems comparison chart

Cooper Lighting Solutions provides many lighting system solutions designed to satisfy code requirements and meet the unique needs of any project.



Luminaire with standalone sensor

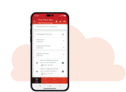

Standalone Spaces WaveLinx LITE



Standalone Spaces WaveLinx CAT



Networked Spaces WaveLinx PRO



Enterprise WaveLinx CORE

	Luminaire with standalone sensor	Standalone Spaces WaveLinx LITE	Standalone Spaces WaveLinx CAT	Networked Spaces WaveLinx PRO	Enterprise WaveLinx CORE
Occupancy	Yes	Yes	Yes	Yes	Yes
Daylighting	Yes	Yes	Yes	Yes	Yes
Wallstations	-	Yes	Yes	Yes	Yes
Gateways	-	-	-	1 WAC	300 WACs
Devices (MAX)	-	40 per Area (1120 per space)	40 per Area	200 per WAC2	32,500 per CORE Enterprise
Software	-	WaveLinx LITE Mobile App	WaveLinx CAT Mobile App	WaveLinx Mobile App	CORE
Areas	-	28 per Space	Unlimited	50 per WAC2	up to 3,000
Zones	-	16 per Area	16 per Area	16 per Area	up to 9,000
Scheduling	-	-	-	Local	Global
VividTune™	-	-	-	Yes	Yes
Plug-Load Control	-	Yes	Yes	Yes	Yes
Low-Voltage Power	-	-	Yes	Yes	Yes
Integration	-	-	-	-	BACnet, API
Dashboards	-	-	-	-	Energy, Occupancy
Configuration	-	Installer	Installer	Technician	Technician / IT