

# ALF G1

## LED Area Light Selectable **CONTRACTOR XP**

Due to continuous product improvements, specification and/or equipment updates may change without notice.



(Images are shown for illustration purposes only)



**ALF Medium Medium Selectable Area Light**  
(Pictured with Adjustable Pole Mount)



**ALF Large Large Selectable Area Light**  
(Pictured with Adjustable Pole Mount)

### SPECIFICATIONS

<b>Housing</b> One-piece, die-cast aluminum housing sealed against moisture and environmental contaminants - features PIN receptacle.	<b>Mounting</b> Square/Round Pole and Slipfitter Mounting options.	<b>Lumen Output</b> <b>Medium Area Light</b> Field selectable: 10,000 - 23,000 Lm. <b>Large Area Light</b> Field selectable: LS450 model: 20,000 - 45,000 Lm. LS600 model: 47,000 - 60,500 Lm.	<b>Electrical</b> Standard 120-277 VAC HVU Option 277-480 VAC 0-10 V dimming driver.	<b>Warranty</b> 5-year limited warranty. Comprehensive warranty terms can be located on <a href="http://www.slgus.com">www.slgus.com</a> .	<b>Certifications</b> UL Listed. IP65 rated. FCC compliant. Design Lights Consortium® (DLC) 5.1 Premium qualified product.
<b>Ambient Temperature</b> Suitable for use in -40° C to 45° C (-40° F to 113° F). LS600 Model: -40° C to 40° C (-40° F to 104° F).	<b>Efficacy</b> Up to 162 lumens per watt.	<b>Full Cutoff</b> Full cutoff luminaire when installed at a level 90° angle to the ground.	<b>Optics</b> Available in IES Type II, III, IV, and V distributions. Polycarbonate lens. Can conform to dark sky requirements.	<b>Lifespan</b> L70 > 72,000 hours @ 25° C	
	<b>CCT and CRI</b> Field selectable: 3000K, 4000K, and 5000K - 70 CRI				

### ORDERING GUIDE

Example: ALF LS220 T3 G1 FSK PSC ASR

Fixture	Selectable Lumen Output	Distribution	Generation	Voltage	Selectable CCT	Photocell	Included Mount	Finish	Controls (Optional)	Accessories
• ALF LED Area Light-Flexible	• LS230 10,000 Lm / 60 W 15,500 Lm / 85 W 20,000 Lm / 110 W 23,000 Lm / 140 W	• T2 Type II • T3 Type III • T4 Type IV • T5 Type V	• G1 First Generation	• BLANK 120-277 V • HVU* 347-480 V	• FSK 3000K 4000K 5000K	PSC Ships with Photocell and Shorting Cap.  BLANK Leave this blank when ordering HVU models - these do not include photocell and shorting cap.	• ASR Adjustable Square and Round Pole Mount (ships in same box) • SFD Slipfitter Mount (ships in same box)	• BLANK Dark Bronze • B Black • W White • SG Silver Gray • C** Custom Color	• PC-2 Twist-lock Photocell (480V) <b>OSLG sync</b> • MSB-DCE-06-W-BT5.0 Bluetooth Plug-in Sensor/Controller - Photocell+PIR (MSB-20-L7-W NDT included) • MSB-DCE-06-W Bluetooth Sensor, Daylight Harvest+PIR L7 Motion sensor lens • FCB-DCE-02-W Bluetooth Plug-in Controller Node <b>Standalone Controls</b> • MS-DCE-09-W Standalone Motion Sensor • RM06 Remote controller for standalone motion sensor	• ALF-M-EGS External glare shield for ALF LS230 (available in Dark bronze, black, silver, and white) • ALF-L-EGS External glare shield for ALF LS450 / LS600 (available in Dark bronze, black, silver, and white) • ALF-M-HGS Housing side glare shield for ALF LS230 (available in Dark bronze, black, silver, and white) • ALF-L-HGS Housing side glare shield for ALF LS450 / LS600 (available in Dark bronze, black, silver, and white) • ALF-M-BLS Back light control for ALF LS230 • ALF-L-BLS Back light control for ALF LS450 / LS600
	• LS450 20,000 Lm / 120 W 28,500 Lm / 180 W 38,500 Lm / 240 W 45,000 Lm / 300 W									
• LS600 <sup>Ⓞ</sup>	47,000 Lm / 300 W 51,000 Lm / 320 W 56,000 Lm / 360 W 60,500 Lm / 400 W									

\* HVU option does not ship with PIN receptacle, Photocell, shorting cap, or ASR mount.

\*\*For a custom color, please call to place your order.

Ⓞ ALF LS600 model is 4000K/5000K switch selectable.

## CATALOGUE



### DARK BRONZE 120-277V



Adjustable Pole mount

Catalog Number	Dist.	Description	Lumens	Watts	CCT	Voltage	Mount
ALF LS230 T3 G1 FSK PSC ASR	T3	Area Light - 4 Level Wattage Adjustable, Gen1, With 3 Pin Photocell & Shorting Cap	Selectable 10,000 - 23,000 Lm	Selectable 60 - 140W	Selectable 3000K - 5000K	120-277V	Included Adjustable Pole Mount
ALF LS230 T4 G1 FSK PSC ASR	T4	Area Light - 4 Level Wattage Adjustable, Gen1, With 3 Pin Photocell & Shorting Cap	Selectable 10,000 - 23,000 Lm	Selectable 60 - 140W	Selectable 3000K - 5000K	120-277V	Included Adjustable Pole Mount
ALF LS230 T5 G1 FSK PSC ASR	T5	Area Light - 4 Level Wattage Adjustable, Gen1, With 3 Pin Photocell & Shorting Cap	Selectable 10,000 - 23,000 Lm	Selectable 60 - 140W	Selectable 3000K - 5000K	120-277V	Included Adjustable Pole Mount
ALF LS450 T3 G1 FSK PSC ASR	T3	Area Light - 4 Level Wattage Adjustable, Gen1, With 3 Pin Photocell & Shorting Cap	Selectable 20,000 - 45,000 Lm	Selectable 120 - 300W	Selectable 3000K - 5000K	120-277V	Included Adjustable Pole Mount
ALF LS450 T4 G1 FSK PSC ASR	T4	Area Light - 4 Level Wattage Adjustable, Gen1, With 3 Pin Photocell & Shorting Cap	Selectable 20,000 - 45,000 Lm	Selectable 120 - 300W	Selectable 3000K - 5000K	120-277V	Included Adjustable Pole Mount
ALF LS450 T5 G1 FSK PSC ASR	T5	Area Light - 4 Level Wattage Adjustable, Gen1, With 3 Pin Photocell & Shorting Cap	Selectable 20,000 - 45,000 Lm	Selectable 120 - 300W	Selectable 3000K - 5000K	120-277V	Included Adjustable Pole Mount
ALF LS600 T3 G1 FSK PSC ASR	T3	Area Light - 4 Level Wattage Adjustable, Gen1, With 3 Pin Photocell & Shorting Cap	Selectable 47,000 - 60,500 Lm	Selectable 300 - 400W	Selectable 4000K - 5000K	120-277V	Included Adjustable Pole Mount
ALF LS600 T4 G1 FSK PSC ASR	T4	Area Light - 4 Level Wattage Adjustable, Gen1, With 3 Pin Photocell & Shorting Cap	Selectable 47,000 - 60,500 Lm	Selectable 300 - 400W	Selectable 4000K - 5000K	120-277V	Included Adjustable Pole Mount
ALF LS600 T5 G1 FSK PSC ASR	T5	Area Light - 4 Level Wattage Adjustable, Gen1, With 3 Pin Photocell & Shorting Cap	Selectable 47,000 - 60,500 Lm	Selectable 300 - 400W	Selectable 4000K - 5000K	120-277V	Included Adjustable Pole Mount



Slipfitter mount

Catalog Number	Dist.	Description	Lumens	Watts	CCT	Voltage	Mount
ALF LS230 T3 G1 FSK PSC SFD	T3	Area Light - 4 Level Wattage Adjustable, Gen1, With 3 Pin Photocell & Shorting Cap	Selectable 10,000 - 23,000 Lm	Selectable 60 - 140W	Selectable 3000K - 5000K	120V-277V	Included Slipfitter Mount
ALF LS450 T3 G1 FSK PSC SFD	T3	Area Light - 4 Level Wattage Adjustable, Gen1, With 3 Pin Photocell & Shorting Cap	Selectable 20,000 - 45,000 Lm	Selectable 120 - 300W	Selectable 3000K - 5000K	120-277V	Included Slipfitter Mount
ALF LS230 T4 G1 FSK PSC SFD	T4	Area Light - 4 Level Wattage Adjustable, T4, Gen1, With 3 Pin Photocell & Shorting Cap	Selectable 10,000 - 23,000 Lm	Selectable 60 - 140W	Selectable 3000K - 5000K	120-277V	Included Slipfitter Mount
ALF LS230 T5 G1 FSK PSC SFD	T5	Area Light - 4 Level Wattage Adjustable, T5, Gen1, With 3 Pin Photocell & Shorting Cap	Selectable 10,000 - 23,000 Lm	Selectable 60 - 140W	Selectable 3000K - 5000K	120-277V	Included Slipfitter Mount
ALF LS450 T4 G1 FSK PSC SFD	T4	Area Light - 4 Level Wattage Adjustable, T4, Gen1, With 3 Pin Photocell & Shorting Cap	Selectable 20,000 - 45,000 Lm	Selectable 120 - 300W	Selectable 3000K - 5000K	120-277V	Included Slipfitter Mount
ALF LS450 T5 G1 FSK PSC SFD	T5	Area Light - 4 Level Wattage Adjustable, Gen1, With 3 Pin Photocell & Shorting Cap	Selectable 20,000 - 45,000 Lm	Selectable 120 - 300W	Selectable 3000K - 5000K	120-277V	Included Slipfitter Mount
ALF LS600 T3 G1 FSK PSC SFD	T3	Area Light - 4 Level Wattage Adjustable, Gen1, With 3 Pin Photocell & Shorting Cap	Selectable 47,000 - 60,500 Lm	Selectable 300 - 400W	Selectable 4000K - 5000K	120-277V	Included Slipfitter Mount
ALF LS600 T4 G1 FSK PSC SFD	T4	Area Light - 4 Level Wattage Adjustable, Gen1, With 3 Pin Photocell & Shorting Cap	Selectable 47,000 - 60,500 Lm	Selectable 300 - 400W	Selectable 4000K - 5000K	120-277V	Included Slipfitter Mount
ALF LS600 T5 G1 FSK PSC SFD	T5	Area Light - 4 Level Wattage Adjustable, Gen1, With 3 Pin Photocell & Shorting Cap	Selectable 47,000 - 60,500 Lm	Selectable 300 - 400W	Selectable 4000K - 5000K	120-277V	Included Slipfitter Mount

### DARK BRONZE HVU 277-480V

Catalog Number	Dist.	Description	Lumens	Watts	CCT	Voltage	Mount
ALF LS230 T3 G1 HVU FSK	T3	Area Light - 4 Level Wattage Adjustable, Gen1, High Voltage	Selectable 10,000 - 23,000 Lm	Selectable 60 - 140W	Selectable 3000K - 5000K	277 - 480V	NOT INCLUDED
ALF LS450 T3 G1 HVU FSK	T3	Area Light - 4 Level Wattage Adjustable, Gen1, High Voltage	Selectable 20,000 - 45,000 Lm	Selectable 120 - 300W	Selectable 3000K - 5000K	277 - 480V	NOT INCLUDED
ALF LS600 T3 G1 HVU FSK	T3	Area Light - 4 Level Wattage Adjustable, Gen1, High Voltage	Selectable 47,000 - 60,500 Lm	Selectable 300 - 400W	Selectable 4000K - 5000K	277 - 480V	NOT INCLUDED

# ALF G1



## WHITE 120-277V

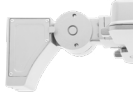

Adjustable Pole mount



Slipfitter mount

Catalog Number	Dist.	Description	Lumens	Watts	CCT	Voltage	Mount
ALF LS230 T3 G1FSK PSC ASR W	T3	Area Light - 4 Level Wattage Adjustable, Gen1, With 3 Pin Photocell & Shorting Cap, White	Selectable 10,000 - 23,000 Lm	Selectable 60 - 140W	Selectable 3000K - 5000K	120-277V	Included Adjustable Pole Mount
ALF LS450 T3 G1FSK PSC ASR W	T3	Area Light - 4 Level Wattage Adjustable, Gen1, With 3 Pin Photocell & Shorting Cap, White	Selectable 20,000 - 45,000 Lm	Selectable 120 - 300W	Selectable 3000K - 5000K	120-277V	Included Adjustable Pole Mount
ALF LS600 T3 G1FSK PSC ASR W	T3	Area Light - 4 Level Wattage Adjustable, Gen1, With 3 Pin Photocell & Shorting Cap, White	Selectable 47,000 - 60,500 Lm	Selectable 300 - 400W	Selectable 4000K - 5000K	120-277V	Included Adjustable Pole Mount
ALF LS230 T3 G1FSK PSC SFD W	T3	Area Light - 4 Level Wattage Adjustable, Gen1, With 3 Pin Photocell & Shorting Cap, White	Selectable 10,000 - 23,000 Lm	Selectable 60 - 140W	Selectable 3000K - 5000K	120-277V	Included Slipfitter Mount
ALF LS450 T3 G1FSK PSC SFD W	T3	Area Light - 4 Level Wattage Adjustable, Gen1, With 3 Pin Photocell & Shorting Cap, White	Selectable 20,000 - 45,000 Lm	Selectable 120 - 300W	Selectable 3000K - 5000K	120-277V	Included Slipfitter Mount



## BLACK 120-277V



Adjustable Pole mount

Catalog Number	Dist.	Description	Lumens	Watts	CCT	Voltage	Mount
ALF LS230 T3 G1FSK PSC ASR B	T3	Area Light - 4 Level Wattage Adjustable, Gen1, With 3 Pin Photocell & Shorting Cap, Black	Selectable 10,000 - 23,000 Lm	Selectable 60 - 140W	Selectable 3000K - 5000K	120-277V	Included Adjustable Pole Mount
ALF LS450 T3 G1FSK PSC ASR B	T3	Area Light - 4 Level Wattage Adjustable, Gen1, With 3 Pin Photocell & Shorting Cap, Black	Selectable 20,000 - 45,000 Lm	Selectable 120 - 300W	Selectable 3000K - 5000K	120-277V	Included Adjustable Pole Mount
ALF LS600 T3 G1FSK PSC ASR B	T3	Area Light - 4 Level Wattage Adjustable, Gen1, With 3 Pin Photocell & Shorting Cap, Black	Selectable 47,000 - 60,500 Lm	Selectable 300 - 400W	Selectable 4000K - 5000K	120-277V	Included Adjustable Pole Mount



## SILVER GREY 120-277V

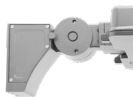

Adjustable Pole mount

Catalog Number	Dist.	Description	Lumens	Watts	CCT	Voltage	Mount
ALF LS230 T3 G1FSK PSC ASR SG	T3	Area Light - 4 Level Wattage Adjustable, Gen1, With 3 Pin Photocell & Shorting Cap, Silver Grey	Selectable 10,000 - 23,000 Lm	Selectable 60 - 140W	Selectable 3000K - 5000K	120-277V	Included Adjustable Pole Mount
ALF LS450 T3 G1FSK PSC ASR SG	T3	Area Light - 4 Level Wattage Adjustable, Gen1, With 3 Pin Photocell & Shorting Cap, Silver Grey	Selectable 20,000 - 45,000 Lm	Selectable 120 - 300W	Selectable 3000K - 5000K	120-277V	Included Adjustable Pole Mount
ALF LS600 T3 G1FSK PSC ASR SG	T3	Area Light - 4 Level Wattage Adjustable, Gen1, With 3 Pin Photocell & Shorting Cap, Silver Grey	Selectable 47,000 - 60,500 Lm	Selectable 300 - 400W	Selectable 4000K - 5000K	120-277V	Included Adjustable Pole Mount

Type II and additional options available upon special request.

## ALF DIMENSIONS

### ALF LS230 W/ Adjustable Pole Mount

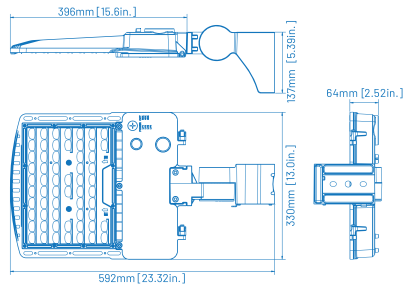

Net Weight
10.38 lbs

### ALF LS450/LS600 W/ Adjustable Pole Mount

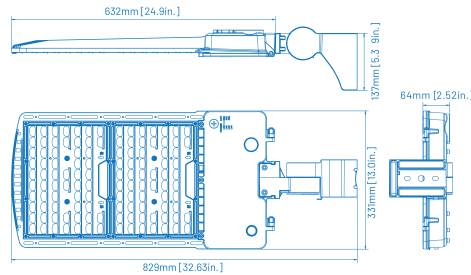

Model	Net Weight
LS450	15.26 lbs
LS600	16.79 lbs

### ALF LS230 W/ Adjustable Slipfitter Mount

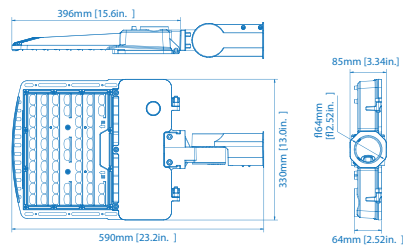

Net Weight
10.34 lbs

### ALF LS450/LS600 W/ Adjustable Slipfitter Mount

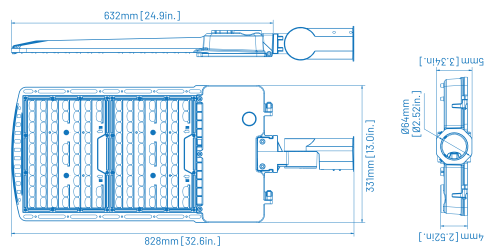

Model	Net Weight
LS450	15.21 lbs
LS600	16.78 lbs

### ALF LS230 W/ Wall Mount

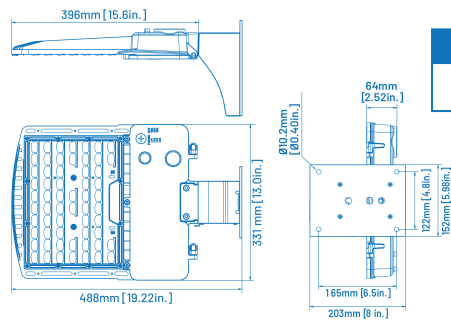

Net Weight
12.77 lbs

### ALF LS450/LS600 W/ Wall Mount

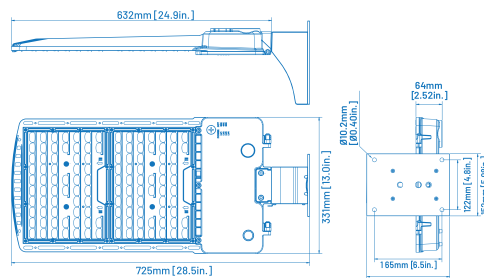

Model	Net Weight
LS450	17.65 lbs
LS600	19.18 lbs

### ALF LS230 W/ Trunnion Mount

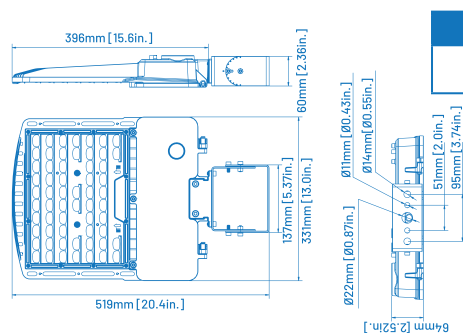

Net Weight
9.57 lbs

### ALF LS450/LS600 W/ Trunnion Mount

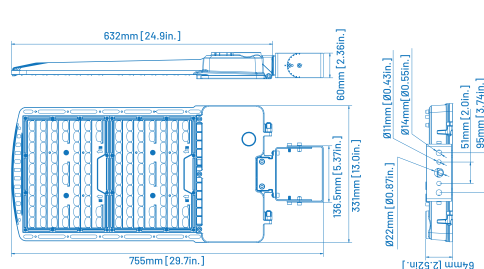

Model	Net Weight
LS450	14.45 lbs
LS600	15.98 lbs

# ALF G1

## MOUNTING DIMENSIONS

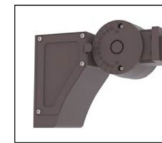
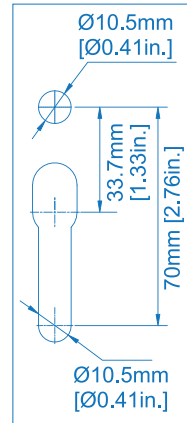
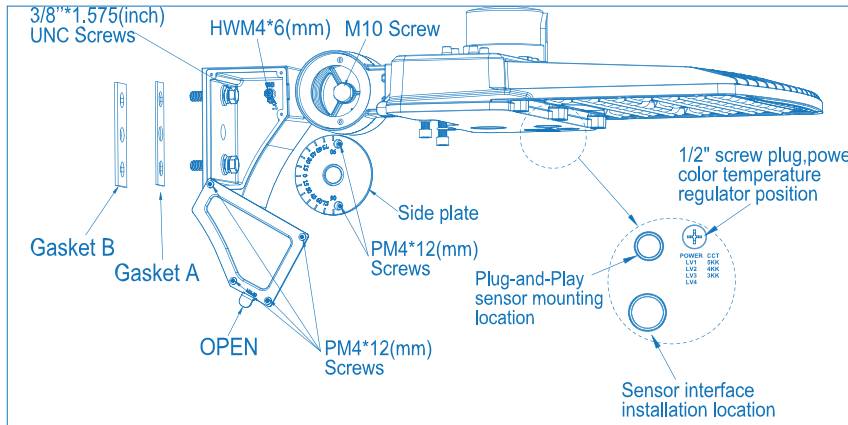

**ASR**  
Adjustable Square and Round Pole Mount



ALC-SPAR



**SFD**  
Slipfitter Mount



ALC-WMB



ALC-T

## PHOTOMETRIC

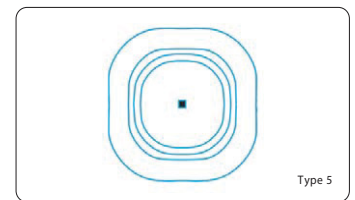
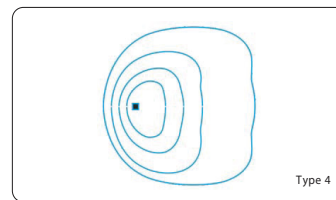
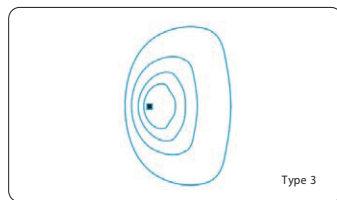
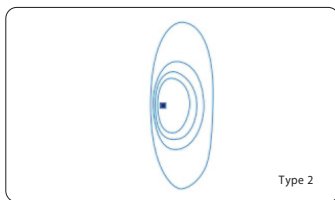

## ELECTRICAL LOAD

	Power Setting	Wattage	Current (A)					Current (A)	
			120V	208V	240V	277V		347V	480V
ALF LS230	Low	60 W	0.5	0.29	0.29	0.22	ALF LS230 HVU	0.17	0.13
	Med	85 W	0.71	0.41	0.41	0.31		0.24	0.18
	High	110 W	0.92	0.53	0.53	0.4		0.32	0.23
	Max	140 W	1.17	0.67	0.67	0.51		0.4	0.29
ALF LS450	Low	120 W	1	0.58	0.5	0.43	ALF LS450 HVU	0.35	0.25
	Med	180 W	1.5	0.87	0.75	0.65		0.52	0.38
	High	240 W	2	1.15	1	0.87		0.69	0.5
	Max	300 W	2.5	1.44	1.25	1.08		0.86	0.63
ALF LS600	Low	300 W	2.5	1.4	1.25	1.1	ALF LS600 HVU	0.86	0.63
	Med	320 W	2.7	1.5	1.3	1.2		0.92	0.67
	High	360 W	3	1.7	1.5	1.3		1	0.75
	Max	400 W	3.3	1.9	1.7	1.4		1.2	0.83

## EPA OF AREA LIGHT

ITEM							
140W	0.3632	0.6849	0.8861	0.7264	1.0481	1.2078	1.0481
300W / 400W	0.4758	0.8091	1.059	0.9516	1.2849	1.3923	1.2849

## BUG @5000K

MODEL #	SYSTEM WATTS	VOLTAGE	DIST. TYPE	B	U	G
ALF LS230 T3	140W	120-277V / 277-480V	III	3	0	3
ALF LS450 T3	300W	120-277V / 277-480V	III	4	0	4
ALF LS600 T3	400W	120-277V / 277-480V	III	5	0	5

# ALF G1



## PERFORMANCE

Series Number	Power Percentage	Wattage	DIST. TYPE	CRI	3000K		4000K		5000K	
					LUMENS	LPW	LUMENS	LPW	LUMENS	LPW
ALF LS230	100%	140 W	III	70	19,200 Lm	143 Lm/W	23,000 Lm	164 Lm/W	21,000 Lm	150 Lm/W
	80%	120 W	III	70	18,000 Lm	150 Lm/W	20,000 Lm	167 Lm/W	18,500 Lm	154 Lm/W
	60%	90 W	III	70	14,000 Lm	156 Lm/W	15,500 Lm	172 Lm/W	14,500 Lm	161 Lm/W
	40%	60 W	III	70	9,700 Lm	162 Lm/W	10,600 Lm	177 Lm/W	10,000 Lm	167 Lm/W
ALF LS450	100%	300 W	III	70	41,000 Lm	137 Lm/W	45,000 Lm	150 Lm/W	42,000 Lm	140 Lm/W
	80%	240 W	III	70	35,000 Lm	146 Lm/W	38,500 Lm	160 Lm/W	36,000 Lm	150 Lm/W
	60%	180 W	III	70	28,000 Lm	156 Lm/W	30,000 Lm	167 Lm/W	28,500 Lm	158 Lm/W
	40%	120 W	III	70	19,200 Lm	160 Lm/W	21,500 Lm	179 Lm/W	20,000 Lm	167 Lm/W
ALF LS600	100%	400 W	III	70	N/A	N/A	60,500 Lm	151 Lm/W	60,000 Lm	150 Lm/W
	80%	360 W	III	70			56,000 Lm	156 Lm/W	55,000 Lm	153 Lm/W
	60%	320 W	III	70			51,000 Lm	159 Lm/W	50,000 Lm	156 Lm/W
	40%	300 W	III	70			47,000 Lm	162 Lm/W	46,000 Lm	159 Lm/W

## ACCESSORIES



**PSC**  
Twist-lock Photocell (120-277V)  
with shorting cap  
(ship with all 120-277V ALF models)



**PC-2**  
Twist-lock Photocell (480V)



**MSB-DCE-06-W**  
Bluetooth Plug-in Controller/  
Sensor



**MS-DCE-09-W**  
Standalone Motion Sensor



**FCB-DCE-02-W**  
Bluetooth Plug-in Node



**RM06**  
Remote for motion sensor



## GLARE SHIELDS

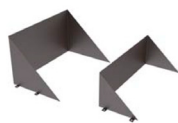

**ALF-EGS**  
External Glare Shields



**ALF-HGS**  
Housing Side  
Glare Shields



**ALF-BLS**  
Back light control

Catalog Number	Compatible Model	Finish
ALF-M-EGS	ALF LS230	Dark Bronze
ALF-M-EGS-W	ALF LS230	White
ALF-M-EGS-B	ALF LS230	Black
ALF-M-EGS-SG	ALF LS230	Silver Grey

Catalog Number	Compatible Model	Finish
ALF-L-EGS	ALF LS450 / LS800	Dark Bronze
ALF-L-EGS-W	ALF LS450 / LS800	White
ALF-L-EGS-B	ALF LS450 / LS800	Black
ALF-L-EGS-SG	ALF LS450 / LS800	Silver Grey

Catalog Number	Compatible Model	Finish
ALF-M-HGS	ALF LS230	Dark Bronze
ALF-M-HGS-W	ALF LS230	White
ALF-M-HGS-B	ALF LS230	Black
ALF-M-HGS-SG	ALF LS230	Silver Grey

Catalog Number	Compatible Model	Finish
ALF-L-HGS	ALF LS450 / LS800	Dark Bronze
ALF-L-HGS-W	ALF LS450 / LS800	White
ALF-L-HGS-B	ALF LS450 / LS800	Black
ALF-L-HGS-SG	ALF LS450 / LS800	Silver Grey

Catalog Number	Compatible Model
ALF-M-BLS	ALF LS230
ALF-L-BLS	ALF LS450 / LS800

## PROJECTED LUMINAIRE MAINTENANCE

### ALF LS230 G1 FSK (AT 140W)

LM-80 Testing Details	
Total number of units tested per case temp:	30
Number of failures:	0
Number of units measured:	30
Test duration (hours):	12,000
Tested drive current (mA):	120
Tested case temperature 1 (T <sub>c</sub> , °C):	85
Tested case temperature 2 (T <sub>c</sub> , °C):	105

Test Data for 85°C Case Temp	
Time (hours)	Lumen Maintenance (%)
0	100.00%
1,000	100.10%
2,000	99.87%
3,000	99.56%
4,000	99.14%
5,000	98.66%
6,000	98.24%
7,000	97.87%
8,000	97.54%
9,000	97.26%
10,000	96.93%
11,000	96.74%
12,000	96.58%

Test Data for 105°C Case Temp	
Time (hours)	Lumen Maintenance (%)
0	100.00%
1,000	99.68%
2,000	99.35%
3,000	98.90%
4,000	98.37%
5,000	97.81%
6,000	97.36%
7,000	96.94%
8,000	96.48%
9,000	96.01%
10,000	95.65%
11,000	95.10%
12,000	94.66%

Results	
Time (t) at which to estimate Lumen maintenance (hours):	50,000
Lumen maintenance at time (t) (%):	86.47%
Reported L70 (hours):	>72,000

### ALF LS450 G1 FSK (AT 300W)

LM-80 Testing Details	
Total number of units tested per case temp:	30
Number of failures:	0
Number of units measured:	30
Test duration (hours):	12,000
Tested drive current (mA):	120
Tested case temperature 1 (T <sub>c</sub> , °C):	85
Tested case temperature 2 (T <sub>c</sub> , °C):	105

Test Data for 85°C Case Temp	
Time (hours)	Lumen Maintenance (%)
0	100.00%
1,000	100.10%
2,000	99.87%
3,000	99.56%
4,000	99.14%
5,000	98.66%
6,000	98.24%
7,000	97.87%
8,000	97.54%
9,000	97.26%
10,000	96.93%
11,000	96.74%
12,000	96.58%

Test Data for 105°C Case Temp	
Time (hours)	Lumen Maintenance (%)
0	100.00%
1,000	99.68%
2,000	99.35%
3,000	98.90%
4,000	98.37%
5,000	97.81%
6,000	97.36%
7,000	96.94%
8,000	96.48%
9,000	96.01%
10,000	95.65%
11,000	95.10%
12,000	94.66%

Results	
Time (t) at which to estimate Lumen maintenance (hours):	50,000
Lumen maintenance at time (t) (%):	86.47%
Reported L70 (hours):	>72,000

## DLC Product ID

MODEL NUMBER	ID NUMBER
ALF LS230 T2 G1 FSK	S-SM1C0N
ALF LS230 T3 G1 FSK	S-IC8M3S
ALF LS230 T4 G1 FSK	S-CNQPL6
ALF LS230 T5 G1 FSK	S-7W51J3
ALF LS450 T2 G1 FSK	S-VGYJNP
ALF LS450 T3 G1 FSK	S-S5L0TG
ALF LS450 T4G1 FSK	S-9ALW8H
ALF LS450 T5 G1 FSK	S-LOG3PV
ALF LS600 T2 G1 FSK	S-4YMH0H
ALF LS600 T3 G1 FSK	S-TG286H
ALF LS600 T4 G1 FSK	S-LD6LP9
ALF LS600 T5 G1 FSK	S-9YDMMJ

**NOTE:** ID numbers apply regardless of mount, finish color, or power type.