

ALF G1

LED Area Light Selectable **CONTRACTOR XP**

Due to continuous product improvements, specification and/or equipment updates may change without notice.



(Images are shown for illustration purposes only)



ALF Medium Medium Selectable Area Light

(Pictured with Adjustable Pole Mount)



ALF Large Large Selectable Area Light

(Pictured with Adjustable Pole Mount)

The ALF G1 Selectable Area Light - Flex Series ships in one package featuring mount, photocell, and shorting cap. The new flex series area light features 4 switch selectable lumen outputs and 3 switch selectable CCT outputs, offering a 12-in-1 solution. Built-in 1/8" jack receptacle makes for easy controls options for optimizing your energy savings.

SPECIFICATIONS

<p>Housing One-piece, die-cast aluminum housing sealed against moisture and environmental contaminants - features PIN receptacle.</p> <p>Ambient Temperature Suitable for use in -40° C to 45° C (-40° F to 113° F). LS600 Model: -40° C to 40° C (-40° F to 104° F).</p>	<p>Mounting Square/Round Pole and Slipfitter Mounting options.</p> <p>Efficacy Up to 162 lumens per watt.</p> <p>CCT and CRI Field selectable: 3000K, 4000K, and 5000K - 70 CRI</p>	<p>Lumen Output Medium Area Light Field selectable: 10,000 - 23,000 Lm. Large Area Light Field selectable: LS450 model: 20,000 - 45,000 Lm. LS600 model: 47,000 - 60,500 Lm.</p>	<p>Electrical Standard 120-277 VAC HVU Option 347-480 VAC 0-10 V dimming driver.</p>	<p>Warranty 5-year limited warranty. Comprehensive warranty terms can be located on www.slgus.com.</p> <p>Optics Available in IES Type II, III, IV, and V distributions. Can conform to dark sky requirements.</p>	<p>Certifications UL Listed for wet locations. FCC compliant. Design Lights Consortium® (DLC) 5.1 Premium qualified product.</p>
---	--	---	---	---	---

PERFORMANCE

Series Number	Power Percentage	Wattage	DIST. TYPE	CRI	3000K		4000K		5000K	
					LUMENS	LPW	LUMENS	LPW	LUMENS	LPW
ALF LS230	100%	140 W	III	70	19,200 Lm	143 Lm/W	23,000 Lm	164 Lm/W	21,000 Lm	150 Lm/W
	80%	120 W	III	70	18,000 Lm	150 Lm/W	20,000 Lm	167 Lm/W	18,500 Lm	154 Lm/W
	60%	90 W	III	70	14,000 Lm	156 Lm/W	15,500 Lm	172 Lm/W	14,500 Lm	161 Lm/W
	40%	60 W	III	70	9,700 Lm	162 Lm/W	10,600 Lm	177 Lm/W	10,000 Lm	167 Lm/W
ALF LS450	100%	300 W	III	70	41,000 Lm	137 Lm/W	45,000 Lm	150 Lm/W	42,000 Lm	140 Lm/W
	80%	240 W	III	70	35,000 Lm	146 Lm/W	38,500 Lm	160 Lm/W	36,000 Lm	150 Lm/W
	60%	180 W	III	70	28,000 Lm	156 Lm/W	30,000 Lm	167 Lm/W	28,500 Lm	158 Lm/W
	40%	120 W	III	70	19,200 Lm	160 Lm/W	21,500 Lm	179 Lm/W	20,000 Lm	167 Lm/W
ALF LS600	100%	400 W	III	70	N/A	N/A	60,500 Lm	151 Lm/W	60,000 Lm	150 Lm/W
	80%	360 W	III	70			56,000 Lm	156 Lm/W	55,000 Lm	153 Lm/W
	60%	320 W	III	70			51,000 Lm	159 Lm/W	50,000 Lm	156 Lm/W
	40%	300 W	III	70			47,000 Lm	162 Lm/W	46,000 Lm	159 Lm/W

CATALOGUE

DARK BRONZE 120-277V

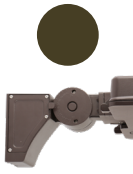

Adjustable Pole mount

Catalog Number	Dist.	Description	Lumens	Watts	CCT	Voltage	Mount
ALF LS450 T3 G1 FSK PSC ASR	T3	Area Light - 4 Level Wattage Adjustable, Gen1, With 3 Pin Photocell & Shorting Cap	Selectable 20,000 - 45,000 Lm	Selectable 120 - 300W	Selectable 3000K - 5000K	120-277V	Included Adjustable Pole Mount
ALF LS230 T4 G1 FSK PSC ASR	T4	Area Light - 4 Level Wattage Adjustable, Gen1, With 3 Pin Photocell & Shorting Cap	Selectable 10,000 - 23,000 Lm	Selectable 60 - 140W	Selectable 3000K - 5000K	120-277V	Included Adjustable Pole Mount
ALF LS230 T5 G1 FSK PSC ASR	T5	Area Light - 4 Level Wattage Adjustable, Gen1, With 3 Pin Photocell & Shorting Cap	Selectable 10,000 - 23,000 Lm	Selectable 60 - 140W	Selectable 3000K - 5000K	120-277V	Included Adjustable Pole Mount
ALF LS450 T4 G1 FSK PSC ASR	T4	Area Light - 4 Level Wattage Adjustable, Gen1, With 3 Pin Photocell & Shorting Cap	Selectable 20,000 - 45,000 Lm	Selectable 120 - 300W	Selectable 3000K - 5000K	120-277V	Included Adjustable Pole Mount
ALF LS450 T5 G1 FSK PSC ASR	T5	Area Light - 4 Level Wattage Adjustable, Gen1, With 3 Pin Photocell & Shorting Cap	Selectable 20,000 - 45,000 Lm	Selectable 120 - 300W	Selectable 3000K - 5000K	120-277V	Included Adjustable Pole Mount
ALF LS600 T3 G1 FSK PSC ASR	T3	Area Light - 4 Level Wattage Adjustable, Gen1, With 3 Pin Photocell & Shorting Cap	Selectable 47,000 - 60,500 Lm	Selectable 300 - 400W	Selectable 4000K - 5000K	120-277V	Included Adjustable Pole Mount
ALF LS600 T4 G1 FSK PSC ASR	T4	Area Light - 4 Level Wattage Adjustable, Gen1, With 3 Pin Photocell & Shorting Cap	Selectable 47,000 - 60,500 Lm	Selectable 300 - 400W	Selectable 4000K - 5000K	120-277V	Included Adjustable Pole Mount
ALF LS600 T5 G1 FSK PSC ASR	T5	Area Light - 4 Level Wattage Adjustable, Gen1, With 3 Pin Photocell & Shorting Cap	Selectable 47,000 - 60,500 Lm	Selectable 300 - 400W	Selectable 4000K - 5000K	120-277V	Included Adjustable Pole Mount



Slipfitter mount

Catalog Number	Dist.	Description	Lumens	Watts	CCT	Voltage	Mount
ALF LS230 T3 G1 FSK PSC SFD	T3	Area Light - 4 Level Wattage Adjustable, Gen1, With 3 Pin Photocell & Shorting Cap	Selectable 10,000 - 23,000 Lm	Selectable 60 - 140W	Selectable 3000K - 5000K	120V-277V	Included Slipfitter Mount
ALF LS450 T3 G1 FSK PSC SFD	T3	Area Light - 4 Level Wattage Adjustable, Gen1, With 3 Pin Photocell & Shorting Cap	Selectable 20,000 - 45,000 Lm	Selectable 120 - 300W	Selectable 3000K - 5000K	120-277V	Included Slipfitter Mount
ALF LS230 T4 G1 FSK PSC SFD	T4	Area Light - 4 Level Wattage Adjustable, T4, Gen1, With 3 Pin Photocell & Shorting Cap	Selectable 10,000 - 23,000 Lm	Selectable 60 - 140W	Selectable 3000K - 5000K	120-277V	Included Slipfitter Mount
ALF LS230 T5 G1 FSK PSC SFD	T5	Area Light - 4 Level Wattage Adjustable, T5, Gen1, With 3 Pin Photocell & Shorting Cap	Selectable 10,000 - 23,000 Lm	Selectable 60 - 140W	Selectable 3000K - 5000K	120-277V	Included Slipfitter Mount
ALF LS450 T4 G1 FSK PSC SFD	T4	Area Light - 4 Level Wattage Adjustable, T4, Gen1, With 3 Pin Photocell & Shorting Cap	Selectable 20,000 - 45,000 Lm	Selectable 120 - 300W	Selectable 3000K - 5000K	120-277V	Included Slipfitter Mount
ALF LS450 T5 G1 FSK PSC SFD	T5	Area Light - 4 Level Wattage Adjustable, Gen1, With 3 Pin Photocell & Shorting Cap	Selectable 20,000 - 45,000 Lm	Selectable 120 - 300W	Selectable 3000K - 5000K	120-277V	Included Slipfitter Mount
ALF LS600 T3 G1 FSK PSC SFD	T3	Area Light - 4 Level Wattage Adjustable, Gen1, With 3 Pin Photocell & Shorting Cap	Selectable 47,000 - 60,500 Lm	Selectable 300 - 400W	Selectable 4000K - 5000K	120-277V	Included Slipfitter Mount
ALF LS600 T4 G1 FSK PSC SFD	T4	Area Light - 4 Level Wattage Adjustable, Gen1, With 3 Pin Photocell & Shorting Cap	Selectable 47,000 - 60,500 Lm	Selectable 300 - 400W	Selectable 4000K - 5000K	120-277V	Included Slipfitter Mount
ALF LS600 T5 G1 FSK PSC SFD	T5	Area Light - 4 Level Wattage Adjustable, Gen1, With 3 Pin Photocell & Shorting Cap	Selectable 47,000 - 60,500 Lm	Selectable 300 - 400W	Selectable 4000K - 5000K	120-277V	Included Slipfitter Mount

DARK BRONZE HVU 347-480V

Catalog Number	Dist.	Description	Lumens	Watts	CCT	Voltage	Mount
ALF LS230 T3 G1 HVU FSK	T3	Area Light - 4 Level Wattage Adjustable, Gen1, High Voltage	Selectable 10,000 - 23,000 Lm	Selectable 60 - 140W	Selectable 3000K - 5000K	347 - 480V	NOT INCLUDED
ALF LS450 T3 G1 HVU FSK	T3	Area Light - 4 Level Wattage Adjustable, Gen1, High Voltage	Selectable 20,000 - 45,000 Lm	Selectable 120 - 300W	Selectable 3000K - 5000K	347 - 480V	NOT INCLUDED
ALF LS600 T3 G1 HVU FSK	T3	Area Light - 4 Level Wattage Adjustable, Gen1, High Voltage	Selectable 47,000 - 60,500 Lm	Selectable 300 - 400W	Selectable 4000K - 5000K	347 - 480V	NOT INCLUDED

ALF G1



WHITE 120-277V

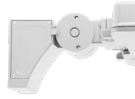

Adjustable Pole mount

Catalog Number	Dist.	Description	Lumens	Watts	CCT	Voltage	Mount
ALF LS230 T3 G1 FSK PSC ASR W	T3	Area Light - 4 Level Wattage Adjustable, Gen1, With 3 Pin Photocell & Shorting Cap, White	Selectable 10,000 - 23,000 Lm	Selectable 60 - 140W	Selectable 3000K - 5000K	120-277V	Included Adjustable Pole Mount
ALF LS450 T3 G1 FSK PSC ASR W	T3	Area Light - 4 Level Wattage Adjustable, Gen1, With 3 Pin Photocell & Shorting Cap, White	Selectable 20,000 - 45,000 Lm	Selectable 120 - 300W	Selectable 3000K - 5000K	120-277V	Included Adjustable Pole Mount
ALF LS600 T3 G1 FSK PSC ASR W	T3	Area Light - 4 Level Wattage Adjustable, Gen1, With 3 Pin Photocell & Shorting Cap, White	Selectable 47,000 - 60,500 Lm	Selectable 300 - 400W	Selectable 4000K - 5000K	120-277V	Included Adjustable Pole Mount
ALF LS230 T3 G1 FSK PSC SFD W	T3	Area Light - 4 Level Wattage Adjustable, Gen1, With 3 Pin Photocell & Shorting Cap, White	Selectable 10,000 - 23,000 Lm	Selectable 60 - 140W	Selectable 3000K - 5000K	120-277V	Included Slipfitter Mount
ALF LS450 T3 G1 FSK PSC SFD W	T3	Area Light - 4 Level Wattage Adjustable, Gen1, With 3 Pin Photocell & Shorting Cap, White	Selectable 20,000 - 45,000 Lm	Selectable 120 - 300W	Selectable 3000K - 5000K	120-277V	Included Slipfitter Mount



Slipfitter mount



BLACK 120-277V



Adjustable Pole mount

Catalog Number	Dist.	Description	Lumens	Watts	CCT	Voltage	Mount
ALF LS230 T3 G1 FSK PSC ASR B	T3	Area Light - 4 Level Wattage Adjustable, Gen1, With 3 Pin Photocell & Shorting Cap, Black	Selectable 10,000 - 23,000 Lm	Selectable 60 - 140W	Selectable 3000K - 5000K	120-277V	Included Adjustable Pole Mount
ALF LS450 T3 G1 FSK PSC ASR B	T3	Area Light - 4 Level Wattage Adjustable, Gen1, With 3 Pin Photocell & Shorting Cap, Black	Selectable 20,000 - 45,000 Lm	Selectable 120 - 300W	Selectable 3000K - 5000K	120-277V	Included Adjustable Pole Mount
ALF LS600 T3 G1 FSK PSC ASR B	T3	Area Light - 4 Level Wattage Adjustable, Gen1, With 3 Pin Photocell & Shorting Cap, Black	Selectable 47,000 - 60,500 Lm	Selectable 300 - 400W	Selectable 4000K - 5000K	120-277V	Included Adjustable Pole Mount



SILVER GREY 120-277V

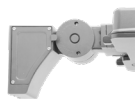

Adjustable Pole mount

Catalog Number	Dist.	Description	Lumens	Watts	CCT	Voltage	Mount
ALF LS230 T3 G1 FSK PSC ASR SG	T3	Area Light - 4 Level Wattage Adjustable, Gen1, With 3 Pin Photocell & Shorting Cap, Silver Grey	Selectable 10,000 - 23,000 Lm	Selectable 60 - 140W	Selectable 3000K - 5000K	120-277V	Included Adjustable Pole Mount
ALF LS450 T3 G1 FSK PSC ASR SG	T3	Area Light - 4 Level Wattage Adjustable, Gen1, With 3 Pin Photocell & Shorting Cap, Silver Grey	Selectable 20,000 - 45,000 Lm	Selectable 120 - 300W	Selectable 3000K - 5000K	120-277V	Included Adjustable Pole Mount
ALF LS600 T3 G1 FSK PSC ASR SG	T3	Area Light - 4 Level Wattage Adjustable, Gen1, With 3 Pin Photocell & Shorting Cap, Silver Grey	Selectable 47,000 - 60,500 Lm	Selectable 300 - 400W	Selectable 4000K - 5000K	120-277V	Included Adjustable Pole Mount

Type II and additional options available upon special request.

ALF G1



ALF DIMENSIONS

ALF LS230 W/ Adjustable Pole Mount

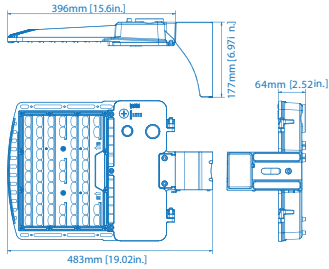

ALF LS450/LS600 W/ Adjustable Pole Mount

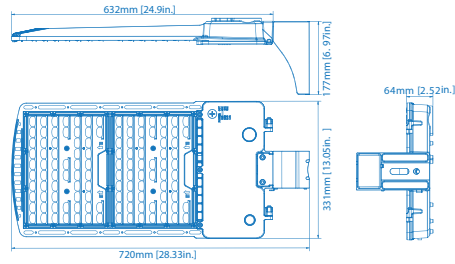

ALF LS230 W/ Adjustable Slipfitter Mount

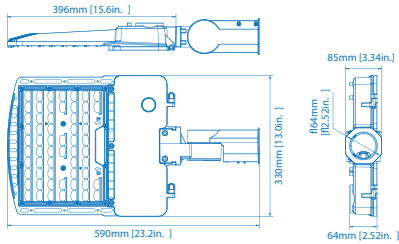

ALF LS450/LS600 W/ Adjustable Slipfitter Mount

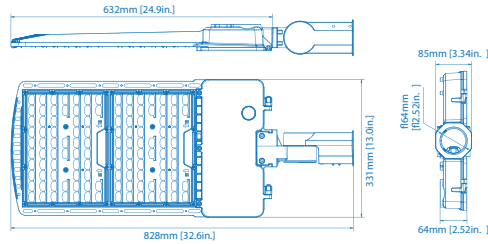

MOUNTING DIMENSIONS

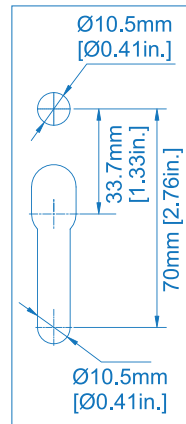
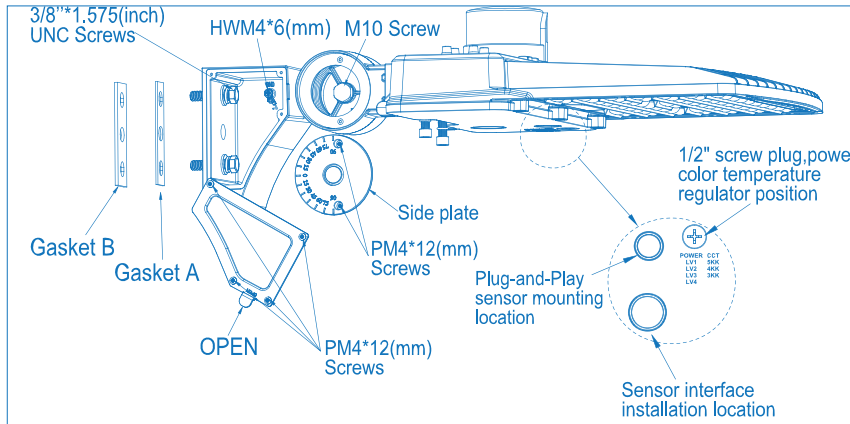

ASR
Adjustable
Square and
Round Pole
Mount



SFD
Slipfitter
Mount

PHOTOMETRIC

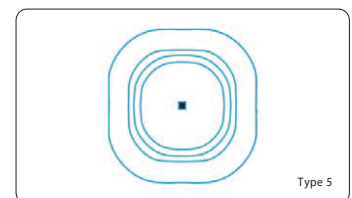
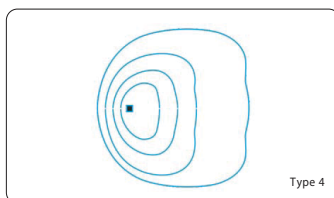
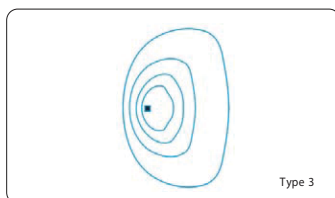
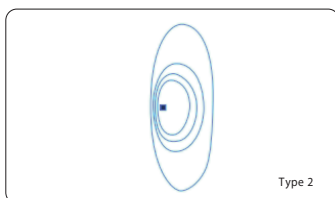

ELECTRICAL LOAD

	Power Setting	Wattage	Current (A)					Current (A)	
			120V	208V	240V	277V		347V	480V
ALF LS230	Low	60 W	0.5	0.29	0.29	0.22	ALF LS230 HVU	0.17	0.13
	Med	85 W	0.71	0.41	0.41	0.31		0.24	0.18
	High	110 W	0.92	0.53	0.53	0.4		0.32	0.23
	Max	140 W	1.17	0.67	0.67	0.51		0.4	0.29
ALF LS450	Low	120 W	1	0.58	0.5	0.43	ALF LS450 HVU	0.35	0.25
	Med	180 W	1.5	0.87	0.75	0.65		0.52	0.38
	High	240 W	2	1.15	1	0.87		0.69	0.5
	Max	300 W	2.5	1.44	1.25	1.08		0.86	0.63
ALF LS600	Low	300 W	2.5	1.4	1.25	1.1	ALF LS600 HVU	0.86	0.63
	Med	320 W	2.7	1.5	1.3	1.2		0.92	0.67
	High	360 W	3	1.7	1.5	1.3		1	0.75
	Max	400 W	3.3	1.9	1.7	1.4		1.2	0.83

EPA OF AREA LIGHT

ITEM							
140W	0.3632	0.6849	0.8861	0.7264	1.0481	1.2078	1.0481
300W / 400W	0.4758	0.8091	1.059	0.9516	1.2849	1.3923	1.2849

BUG @5000K

MODEL #	SYSTEM WATTS	VOLTAGE	DIST. TYPE	B	U	G
ALF LS230 T3	140W	120-277V / 347-480V	III	3	0	3
ALF LS450 T3	300W	120-277V / 347-480V	III	4	0	4
ALF LS600 T3	400W	120-277V / 347-480V	III	5	0	5

ACCESSORIES



PSC
Twist-lock Photocell (120-277V)
with shorting cap
(ship with all 120-277V ALF models)



PC-2
Twist-lock Photocell (480V)



MSB-DCE-06-W
Bluetooth Plug-in Controller/
Sensor



MS-DCE-09-W
Standalone Motion Sensor



FCB-DCE-02-W
Bluetooth Plug-in Node



RM06
Remote for motion sensor

GLARE SHIELDS



ALF-EGS
External Glare Shields

Catalog Number	Compatible Model	Finish
ALF-M-EGS	ALF LS230	Dark Bronze
ALF-M-EGS-W	ALF LS230	White
ALF-M-EGS-B	ALF LS230	Black
ALF-M-EGS-SG	ALF LS230	Silver Grey

Catalog Number	Compatible Model	Finish
ALF-L-EGS	ALF LS450 / LS800	Dark Bronze
ALF-L-EGS-W	ALF LS450 / LS800	White
ALF-L-EGS-B	ALF LS450 / LS800	Black
ALF-L-EGS-SG	ALF LS450 / LS800	Silver Grey



ALF-HGS
Housing Side
Glare Shields

Catalog Number	Compatible Model	Finish
ALF-M-HGS	ALF LS230	Dark Bronze
ALF-M-HGS-W	ALF LS230	White
ALF-M-HGS-B	ALF LS230	Black
ALF-M-HGS-SG	ALF LS230	Silver Grey

Catalog Number	Compatible Model	Finish
ALF-L-HGS	ALF LS450 / LS800	Dark Bronze
ALF-L-HGS-W	ALF LS450 / LS800	White
ALF-L-HGS-B	ALF LS450 / LS800	Black
ALF-L-HGS-SG	ALF LS450 / LS800	Silver Grey

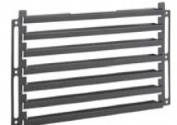

ALF-BLS
Back light control

Catalog Number	Compatible Model
ALF-M-BLS	ALF LS230
ALF-L-BLS	ALF LS450 / LS800

SHIPPING INFORMATION

Product number	Individual box size	Individual box weight	# per carton	# per pallet
ALF LS230	14.57"W x 22.05"L x 4.33"H	12.96 LBS	1	
ALF LS450	14.57"W x 32.28"L x 4.33"H	19.19 LBS	1	
ALF LS600	14.57"W x 32.28"L x 4.33"H	-	1	

PROJECTED LUMINAIRE MAINTENANCE

ALF LS230 G1 FSK (AT 140W)

LM-80 Testing Details	
Total number of units tested per case temp:	30
Number of failures:	0
Number of units measured:	30
Test duration (hours):	12,000
Tested drive current (mA):	120
Tested case temperature 1 (T _c , °C):	85
Tested case temperature 2 (T _c , °C):	105

Test Data for 85°C Case Temp	
Time (hours)	Lumen Maintenance (%)
0	100.00%
1,000	100.10%
2,000	99.87%
3,000	99.56%
4,000	99.14%
5,000	98.66%
6,000	98.24%
7,000	97.87%
8,000	97.54%
9,000	97.26%
10,000	96.93%
11,000	96.74%
12,000	96.58%

Test Data for 105°C Case Temp	
Time (hours)	Lumen Maintenance (%)
0	100.00%
1,000	99.68%
2,000	99.35%
3,000	98.90%
4,000	98.37%
5,000	97.81%
6,000	97.36%
7,000	96.94%
8,000	96.48%
9,000	96.01%
10,000	95.65%
11,000	95.10%
12,000	94.66%

Results	
Time (t) at which to estimate Lumen maintenance (hours):	50,000
Lumen maintenance at time (t) (%):	86.47%
Reported L70 (hours):	>72,000

ALF LS450 G1 FSK (AT 300W)

LM-80 Testing Details	
Total number of units tested per case temp:	30
Number of failures:	0
Number of units measured:	30
Test duration (hours):	12,000
Tested drive current (mA):	120
Tested case temperature 1 (T _c , °C):	85
Tested case temperature 2 (T _c , °C):	105

Test Data for 85°C Case Temp	
Time (hours)	Lumen Maintenance (%)
0	100.00%
1,000	100.10%
2,000	99.87%
3,000	99.56%
4,000	99.14%
5,000	98.66%
6,000	98.24%
7,000	97.87%
8,000	97.54%
9,000	97.26%
10,000	96.93%
11,000	96.74%
12,000	96.58%

Test Data for 105°C Case Temp	
Time (hours)	Lumen Maintenance (%)
0	100.00%
1,000	99.68%
2,000	99.35%
3,000	98.90%
4,000	98.37%
5,000	97.81%
6,000	97.36%
7,000	96.94%
8,000	96.48%
9,000	96.01%
10,000	95.65%
11,000	95.10%
12,000	94.66%

Results	
Time (t) at which to estimate Lumen maintenance (hours):	50,000
Lumen maintenance at time (t) (%):	86.47%
Reported L70 (hours):	>72,000