

ALF G2 - Area Lights - Flex Series - 2nd Gen



CONTRACTOR XP



(Images are shown for illustration purposes only)

Project:
Product #:
Type:

KEY FEATURES

- Power & CCT selectable flex series area light.
- Controls ready with preinstalled zhaga sensor receptacle.
- Ships with mount in box.
- Available in Type II, III, IV, and V.
- 175 Lm/W Efficacy.



SPECIFICATIONS

Housing

Corrosion-resistant, sealed, heavy duty die-cast aluminum.

Ambient Temperature

Suitable for use in -40° C to 45° C (-40° F to 113° F).

Mounting

Adjustable Pole Mount, Slipfitter Mount, Wall Mount, and Trunnion Mount.

Efficacy

Up to 175 lumens per watt.

CCT and CRI

3000K, 4000K, & 5000K - 70 CRI

Lifespan

L70 > 100,000 hours @ 25°C.

Distribution

Type II, III, IV, and V.

Finishes

Dark Bronze, Black, White, Silver Gray and custom.

Electrical

Standard voltage 120-277V. HVU 347-480V. 0-10V dimming driver standard for 10% to 100% dimming capabilities. THD: ≤20%. PF ≥90%.

Surge Protection

10KA (120-277V models)
20KA (347-480V models).

Warranty

5-year limited warranty. Comprehensive warranty terms can be located on www.slgus.com.

Dark Sky

90° mounting options are dark sky friendly

Certifications

UL Listed for wet locations. FCC compliant. Design Lights Consortium® (DLC) 5.1 Premium qualified product pending.

ORDERING GUIDE

Example: **ALF LS500 T4 G2 FSK PSC ASR**

Fixture Type	Selectable Lumen Output	Distribution	Generation	Voltage	CCT	Photocell	Included Mount	Finish
• ALF LED Area Light - Flex Series	<ul style="list-style-type: none"> • LS250 14,000 Lm / 80 W 18,000 Lm / 110 W 22,100 Lm / 140 W 25,000 Lm / 160 W • LS500 33,500 Lm / 198 W 42,000 Lm / 264 W 48,000 Lm / 300 W 50,000 Lm / 330 W • LS600 49,500 Lm / 300 W 50,400 Lm / 320 W 56,600 Lm / 360 W 60,100 Lm / 400 W 	<ul style="list-style-type: none"> • T2 Type II • T3 Type III • T4 Type IV • T5 Type V 	• G2 Second Generation	<ul style="list-style-type: none"> • BLANK 120-277V • HVU* 347-480 V 	<ul style="list-style-type: none"> • FSK 3000K 4000K 5000K • 30K 3000K • 40K 4000K • 50K 5000K 	<ul style="list-style-type: none"> • PSC Ships with Photocell and Shorting Cap. • BLANK Leave this blank when ordering HVU models - these do not include photocell and shorting cap. 	<ul style="list-style-type: none"> • ASR Adjustable Square and Round Pole Mount (ships in same box) • SFD Slipfitter Mount (ships in same box) • BLANK Leave this blank when ordering HVU models - mount is ordered separately (see below) 	<ul style="list-style-type: none"> • BLANK Dark Bronze • B Black • SG Silver Gray • W White • C** Custom Color

*HVU option does not ship with PIN receptacle, photocell, shorting cap or mount. Must order separately. **For a custom color, please call to place your order.

For stocking opportunities please reach out to your local SLG Lighting rep or contact sales@slgus.com. Lead-times may vary based on current inventory levels - always consult your local SLG Lighting rep for lead-times and project needs.

ACCESSORIES

Sensors and controls	SLG Sync App	Mounting	Glare Shield***
<ul style="list-style-type: none"> • MSB-DCE-06-Z10-W-BT5.0-W <small>CSLG Sync™</small> Bluetooth Plug-in Sensor L7 Motion sensor Lens • MS-DCE-09-Z10-L7-W Standalone Motion Sensor • RM-06 Remote control for motion sensor • PC-2 Twist-lock Photocell (480V) 	<ul style="list-style-type: none"> • BLANK Commission and control your system through the free SLG Sync app. Only for SLG Sync™ bluetooth control products. 	<ul style="list-style-type: none"> • ALC-T Trunnion Mount • ALC-WMB Wall Mount • ALF-ASR Adjustable square/round pole mount • ALF-SFD Slipfitter • ALC-SPAR Non-adjustable square/round pole mount 	<ul style="list-style-type: none"> • ALF-M-G2-EGS External glare shield for LS250 (Dark Bronze) • ALF-L-G2-EGS External glare shield for LS500 (Dark Bronze) • ALF-M-G2-HGS Housing glare shield for LS250 (Dark Bronze) • ALF-L-G2-HGS Housing glare shield for LS500 (Dark Bronze) • ALF-M-G2-BLS Back light control shield for LS250, 1 pc. (Dark Bronze) • ALF-L-G2-BLS Back light control shield for LS500/600, 1 pc. (Dark Bronze)

POLES (see pole spec sheet at www.slgus.com/products-sp.html)

Poles	Pole Accessories
<ul style="list-style-type: none"> • SSSP 15/20/25/30 Straight Steel Pole, Square Shaped - 15', 20', 25' or 30' (Predrilled up to 4 fixtures max). • SRSP 15/20/25 Straight Steel Pole, Round - 15', 20' or 25' (Predrilled up to 2 fixtures max). 	<ul style="list-style-type: none"> • 4SQ-SP-D Mount for 4" square pole, vertical tenon. • 5SQ-SP-D Mount for 5" square pole, vertical tenon. • SP-TR-D 2-3/8" OD Tenon Mount adaptor for Trunnion. • 3SQR-SP-D Vertical tenon for non-tapered round poles, 3". • 4SQR-SP-D Vertical tenon for non-tapered round poles, 4". • 5SQR-SP-D Vertical tenon for non-tapered round poles, 5". • R60-SP1-D Horizontal Tenon Bracket, one fixture. • R60-SP2-90-D Tenon Bracket, 90°, two fixtures. • R60-SP2-180-D Tenon Bracket, 180°, two fixtures. • R60-SP3-90-D Tenon Bracket, 90°, three fixtures. • R60-SP4-90-D Tenon Bracket, 90°, four fixtures. • SQ-SP-D Mid-pole bracket, one fixture. • SSBU-2-180-20-T1-T1-BZ Tenon bracket, 180°, 2 fixtures. • SSBU-3-120-20-T1-T1-BZ Tenon bracket, 120°, 3 fixtures. • SSBU-3-180-20-T1-T1-BZ Tenon bracket, 180°, 3 fixtures. • SSBU-4-90-24-T1-T1-BZ Tenon bracket, 90°, 4 fixtures. • WM-SP-D Wall Mount bracket, 90°, one fixture.

***Glare shields are available in dark bronze as a standard finish - black, white, silver gray, and custom finishes available by special request.

Accessories shown are generally stocked items, for additional accessories questions and options please contact your local SLG Lighting rep or email sales@slgus.com.

Options for spec needs available through special request - please contact sales@slgus.com with spec needs and project size.

Due to continuous product improvements, specification and/or equipment updates may change without notice.

PERFORMANCE INFORMATION

Series Number	Power Setting	Wattage	Lumens (3000K)	Efficacy	Lumens (4000K)	Efficacy	Lumens (5000K)	Efficacy
ALF LS250	Max	160 W	22,500 Lm	160 Lm/W	25,000 Lm	175 Lm/W	23,500 Lm	166 Lm/W
	High	140 W	20,000 Lm	149 Lm/W	22,100 Lm	164 Lm/W	21,000 Lm	155 Lm/W
	Medium	110 W	16,500 Lm	143 Lm/W	18,000 Lm	158 Lm/W	17,100 Lm	149 Lm/W
	Low	80 W	12,800 Lm	141 Lm/W	14,000 Lm	156 Lm/W	13,300 Lm	147Lm/W
ALF LS500	Max	330 W	45,000 Lm	152 Lm/W	50,000 Lm	175 Lm/W	46,800 Lm	156 Lm/W
	High	300 W	42,500 Lm	144 Lm/W	48,000 Lm	167 Lm/W	44,000 Lm	148 Lm/W
	Medium	264 W	38,000 Lm	140 Lm/W	42,000 Lm	164 Lm/W	39,000 Lm	144 Lm/W
	Low	198 W	30,000 Lm	136 Lm/W	33,500 Lm	155 Lm/W	31,000 Lm	140 Lm/W
ALF LS600	Max	400 W	58,200 Lm	146 Lm/W	60,500 Lm	151 Lm/W	60,000 Lm	150 Lm/W
	High	360 W	54,800 Lm	152 Lm/W	56,000 Lm	156 Lm/W	55,000 Lm	153 Lm/W
	Medium	320 W	50,400 Lm	158 Lm/W	51,000 Lm	159 Lm/W	50,000 Lm	156 Lm/W
	Low	300 W	48,000 Lm	160 Lm/W	47,000 Lm	162 Lm/W	46,000 Lm	159 Lm/W

Performance information based on rigorous testing and high standards using a random sample set.

BUG RATING

Series Number	Distribution	B	U	G
ALF LS250	T2	4	0	3
	T3	3	0	3
	T4	3	0	3
	T5	4	0	2
ALF LS500	T2	5	0	4
	T3	5	0	4
	T4	4	0	4
	T5	5	0	4

Series Number	Distribution	B	U	G
ALF LS600 @5000K	T3	5	0	5

PHOTOMETRIC

Type 2 optics are ideal for applications where there is a need to space the luminaires farther apart along a road or pathway. The light distribution pattern is optimized for elongated areas, allowing for greater pole spacing without sacrificing lighting quality.

Type 3 optics produce an asymmetrical pattern that directs the majority of the light forward and equally on both sides of the luminaire. In a back-to-back configuration, it creates a rectangular pattern which can extend pole spacings.

Type 4 is suitable for applications where light is primarily required forward with minimal backlight. Typical installations include perimeter poles.

Type 5 optics produce a symmetrical square distribution pattern that distributes light equally on all sides of the luminaire. Type 5 luminaires is universal for most area lighting applications

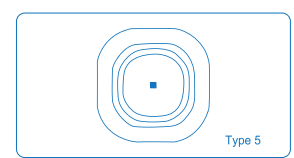
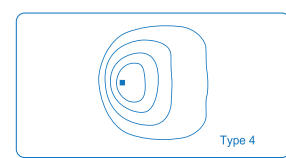
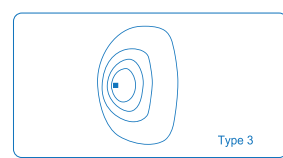
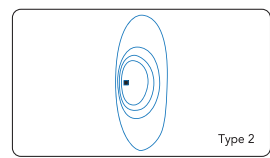

EPA INFORMATION

POWER	1	2 @ 90°	2 @ 120°	2 @ 180°	3 @ 90°	3 @ 120°	4 @ 90°
160 W	0.187	0.387	0.484	0.374	0.574	0.684	0.574
330 W	0.248	0.448	1.176	0.496	0.696	1.376	0.696
400 W	0.4758	0.8091	1.059	0.9516	1.2849	1.3923	1.2849

Due to continuous product improvements, specification and/or equipment updates may change without notice.

MOUNTING



Slipfitter Mount
An optional cast aluminum mast arm adapter secures fixture head to nominal 2-3/8\"/>



Wall Mount
Wall Mount is easy to install for direct wall mounting with 1/2\"/>



Trunnion Mount
Die-cast aluminum trunnion is easily adapted to many surfaces and allows easy fixture aiming angles.



Adjustable Arm Mount
Standard versatile mounting arm is simple to install and can be used with existing poles for retrofit installations.

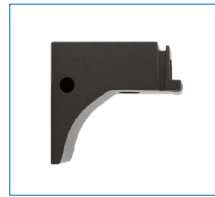

Non-adjustable Pole Mount
For square or round poles. Non-adjustable mount.

MOUNTING DIMENSIONS

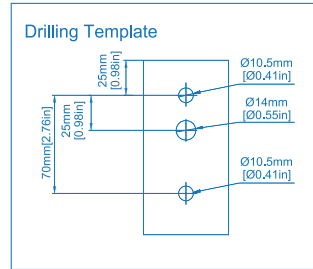
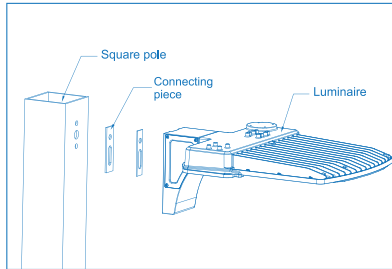
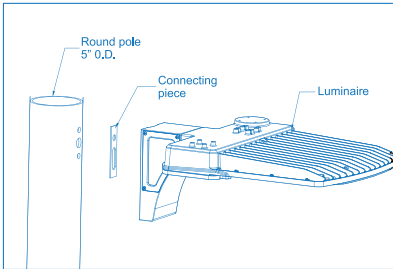

DIMENSIONS

ALF LS250 - with Adjustable Pole Mount

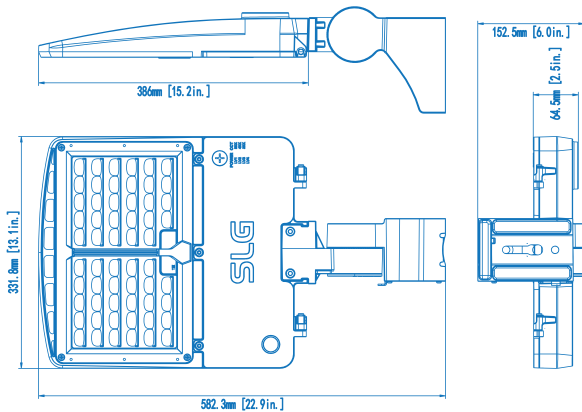

ALF LS250 - with Adjustable Slipfitter Mount

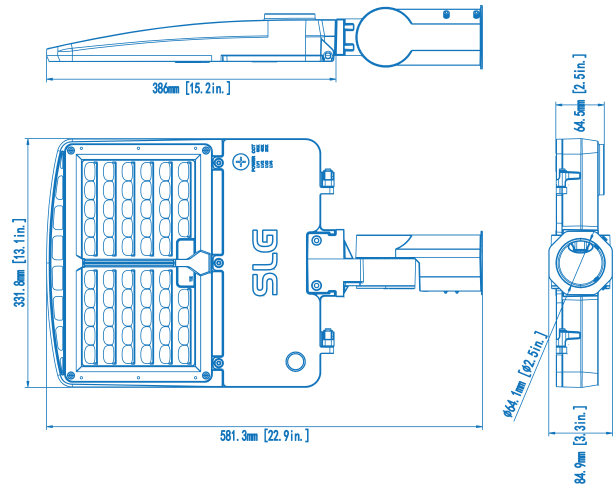

ALF LS250 - with Trunnion Mount

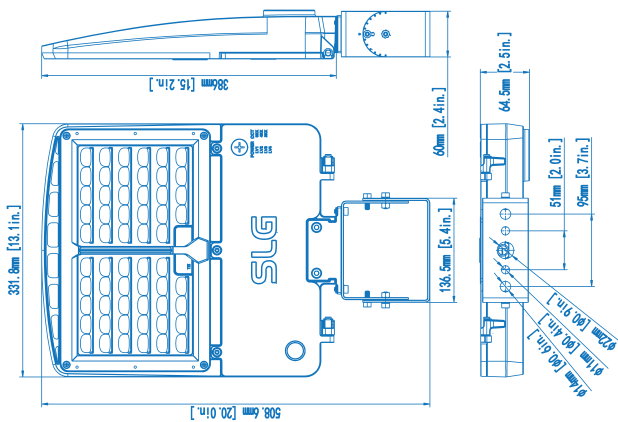

ALF LS250 - with Pole Mount

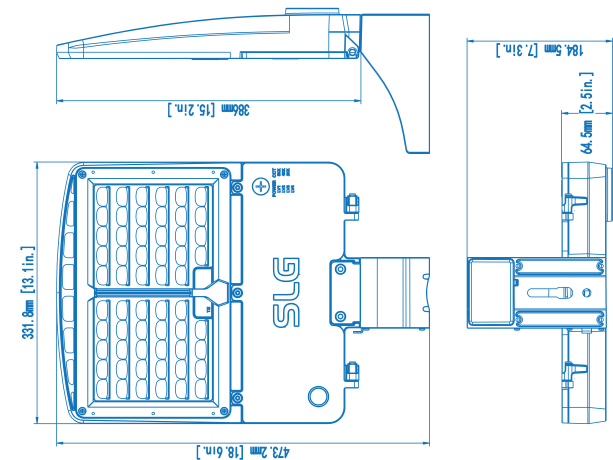

Due to continuous product improvements, specification and/or equipment updates may change without notice.

DIMENSIONS (Continued)

ALF LS500 and LS600 - with Adjustable Pole Mount

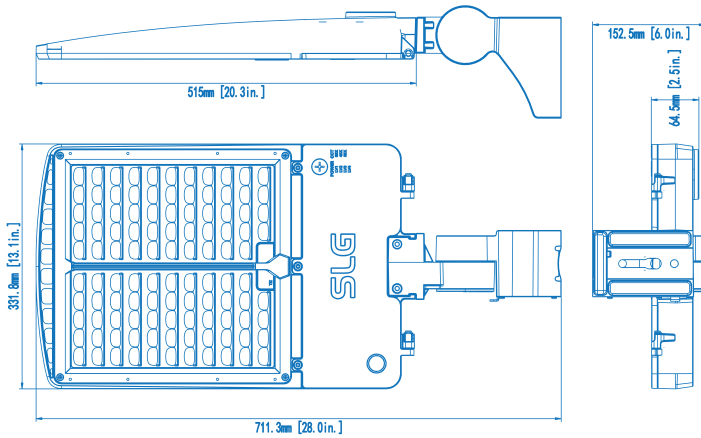

ALF LS500 and LS600 - with Adjustable Slipfitter Mount

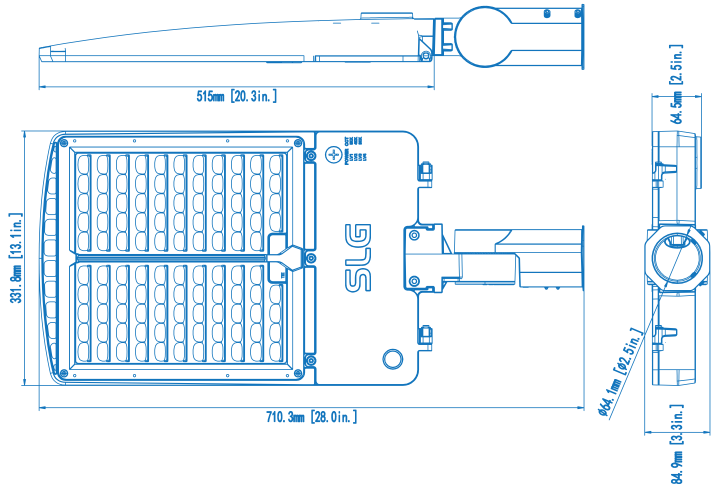

ALF LS500 and LS600 - with Trunnion Mount

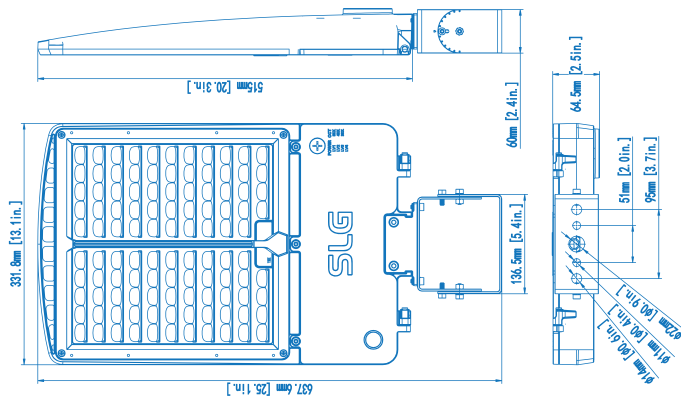

ALF LS500 and LS600 - with Pole Mount

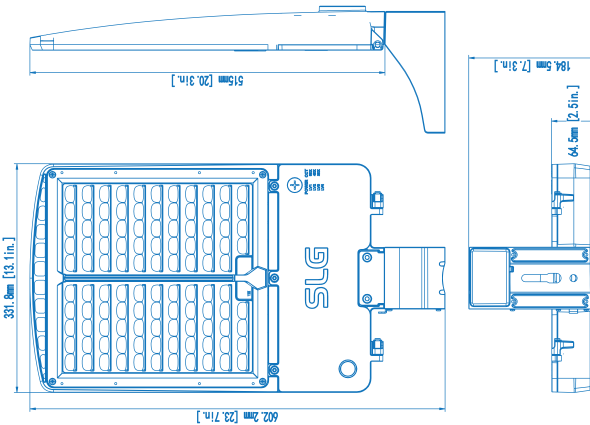

ALF G2 - Weight

Model Number	Net Weight (excluding mount)
ALF G2 LS250	7.03 lbs

Series Number	Net Weight (excluding mount)
ALF G2 LS500	9.97 lbs

Series Number	Net Weight (excluding mount)
ALF G2 LS600	10.67 lbs

Due to continuous product improvements, specification and/or equipment updates may change without notice.

ELECTRICAL LOAD

Series Number	Power	Wattage	120V	208V	240V	277V
ALF LS250 G2	Max	160 W	1.33	0.77	0.67	0.58
	High	140 W	1.17	0.67	0.58	0.51
	Medium	110 W	0.92	0.53	0.46	0.40
	Low	80 W	0.67	0.39	0.33	0.29
ALF LS500 G2	Max	330 W	2.75	1.59	1.38	1.19
	High	300 W	2.5	1.44	1.25	1.08
	Medium	264 W	2.2	1.27	1.1	0.95
	Low	198 W	0.67	0.38	0.33	0.29
ALF LS600 G2	Max	400 W	3.33	1.92	1.67	1.44
	High	360 W	3.00	1.73	1.5	1.30
	Medium	320 W	2.67	1.54	1.3	1.55
	Low	300 W	2.50	1.44	1.25	1.08

Series Number	347V	480V
ALF LS250 G2 HVU	0.46	0.33
	0.40	0.29
	0.31	0.23
	0.23	0.17
ALF LS500 G2 HVU	0.95	0.69
	0.87	0.63
	0.76	0.6
	0.23	0.17
ALF LS600 G2 HVU	1.44	0.83
	1.30	0.75
	1.54	0.67
	1.08	0.63

ACCESSORIES OVERVIEW

Glare Shields



ALF-X-G2-EGS
External Glare Shield





ALF-X-G2-HGS
Housing Side Glare Shield



ALF-X-G2-BLS
Back light control

Poles & Poles Accessories



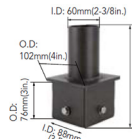

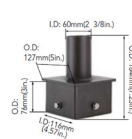

4S0-SP-D
Vertical Tenon

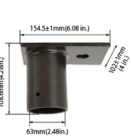

5S0-SP-D
Vertical Tenon



SP-TR-D
Tenon Adaptor for Trunnion Mount



3SQR-SP-D
Vertical Tenon

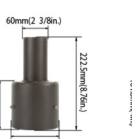

4SQR-SP-D
Vertical Tenon

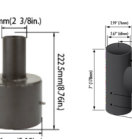

4SQR-SP-D
Vertical Tenon

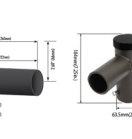

4SQR-SP-D
Vertical Tenon

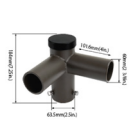

R60-SP2-90-D
Tenon Bracket

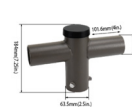

R60-SP2-180-D
Tenon Bracket

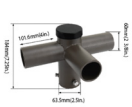

R60-SP3-90-D
Tenon Bracket



R60-SP3-120-D
Tenon Bracket

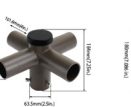

R60-SP4-90-D
Tenon Bracket

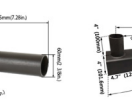

S0-SP-D
Mid-Pole Tenon Bracket

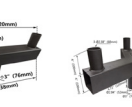

SSBU-2-180-20-T1-T1-BZ
Tenon Bracket

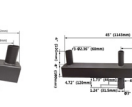

SSBU-3-120-20-T1-T1-BZ
Tenon Bracket

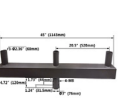

SSBU-3-180-20-T1-T1-BZ
Tenon Bracket



SSBU-4-90-24-T1-T1-BZ
Tenon Bracket



WM-SP-D
Wall Mount Bracket

Due to continuous product improvements, specification and/or equipment updates may change without notice.

SHIPPING INFORMATION

Product number	Individual box size
ALF LS250 G2 FSK	22.05" X 14.57" X 4.72"
ALF LS500 G2 FSK	27.55" X 14.57" X 4.72"

Product number	Individual box size
ALF LS600 G2 FSK	27.55" X 14.57" X 4.72"

BLUETOOTH MOTION SENSOR

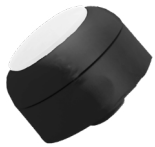

MSB-DCE-06-Z10-BT5.0-W
(Pictured with L7 lens)

SPECIFICATIONS

Input Voltage DC 12V	Bluetooth Transmit 328 ft Max	Housing Material UL 94-5VA Nylon
Input Power 0.6W	Radio Frequency 2.4GHz ± 75MHz	Detection Range 40-80 ft
Input Current 50mA Max	Bluetooth Version 4.2/5.0	Mounting Height 20-40 ft
Output Current 10mA Max	Housing Material UL 94-5VA Nylon	Operating Temperature -20°C to 60°C (68°F to 140°)
Output Power 0.1W	Detection Range 40-80 ft	IP Rating IP66
Dimming 0-10V	Radio Frequency 2.4GHz ± 75MHz	Warranty 5 Year warranty
Sinking Current 10mA Max	Bluetooth Version 4.2/5.0	

COMMISSION

This Bluetooth sensor/controller is easily commissioned via the SLG Sync app, available for download on Google Play and the App Store.

APP DOWNLOAD



For commissioning guide and more information visit:

www.slgsync.com

STANDALONE MOTION SENSOR



MS-DCE-09-Z10-L7-W

SPECIFICATIONS

Input Voltage DC 12V-24 VDC	IP Rating IP65
Input Current 30mA	Detection Range 9 ft
Output Signal DIM 0-10V	Mounting Height Up to 40ft
Detection Angle Fresnel Lens 120°	Operating Temperature -20°C to 60°C (-4°F to 140°F)
	Warranty 5 Year warranty

COMMISSION

This basic sensor is commissioned via the RM06 remote. Either pre-commissioned or commissioned on site.



Due to continuous product improvements, specification and/or equipment updates may change without notice.