

Evolve® EALP Series

LED Area Light



CUSTOMER NAME _____
 Project Name _____
 Date _____ Type _____
 Catalog Number _____

The EALP Area Light luminaire offers a wide range of optical patterns, color temperatures, lumen packages and mounting configurations to optimize area light applications, as well as provide versatility in lighting design within the same form-factor. They are ideal for commercial property site-lighting applications such as retail and commercial exteriors.

CONSTRUCTION

Housing:	Aluminium die cast enclosure. Integral heat sink for maximum heat transfer
Lens:	Impact resistant tempered glass
Paint:	Corrosion resistant polyester powder paint, minimum 2.0 mil thickness Standard = Black, Dark Bronze Gray, White (RAL & custom colors available) Optional = Coastal Finish
Weight:	27 - 30 lbs

OPTICAL SYSTEM

Lumens:	22,700 - 70,700
Photometry:	Type II, III, IV & V
Efficacy:	122 - 146
CCT:	3000K, 4000K, 5000K
CRI:	≥70
Upward Light Output Ration (ULOR):	0 Horizontal Orientation

ELECTRICAL

Input Voltage:	120-277V, 277-480V & 347-480V
Input Frequency:	50/60 Hz
Power Factor (PH):	> 90% at rated watts
Total Harmonic Distortion (THD):	< 20% at rated watts

SURGE PROTECTION

TYPICAL (120 STRIKES)		
6kV/3kA*	10kV/5kA*	20kV/10kA*

*Per ANSI C136.2-2015

LUMEN MAINTENANCE

Projected Lxx per IES TM-21-11 at 25°C

Optics	LXX(10K) @ Hours		
	25,000 HR	50,000 HR	60,000 HR
J5, K2, K3, K4, K5	L96	L92	L91
L2, L3, L4, L5, M2, M3, M4, M5	L95	L93	L92
J2, J3, J4, N2, N3, N4, N5	L95	L93	L92
P2, P3, P4, P5, Q2, Q3, Q4, Q5	L95	L93	L92

Note: Projected Lxx based on LM80 (= 10,000 hour testing). Accepted industry tolerances apply to initial luminous flux and lumen maintenance measurements

LUMINAIRE AMBIENT TEMPERATURE FACTOR

Ambient Temp (°C)	Initial Flux Factor	Ambient Temp (°C)	Initial Flux Factor
10	1.02	30	0.99
20	1.01	40	0.98
25	1.00		

RATINGS

Operating Temperature:	-40° C to 40° C
Vibration:	3G per ANSI C136.31-2010
LM-79:	Testing in accordance with IESNA Standards

CONTROLS

Dimming:	Standard - 0-10V Optional - DALI (Option U)
Sensors:	Photo Electric Sensors (PE) available LightGrid and Daintree Compatible

WARRANTY

5 Year (Standard)

10 Year (Optional)

Evolve® EALP Series

LED Area Light

Catalog Logic

CUSTOMER NAME

Project Name _____

Date _____ Type _____

Catalog Number _____

Ordering Information

EALP 03 7

PROD. ID	GENERATION	VOLTAGE	OPTICAL CODE	DISTRIBUTION	CRI	CCT	DIMMING ²	CONTROLS	MOUNTING	COLOR	OPTIONS
E= EVOLVE	03 = Generation	0 ¹ = 120-277	Jx = 25000	SM = Symmetric Medium	7 = 70 (min)	30 ¹¹ = 3000K	N = Dimming thru PE receptacle	A = ANSI C136.41 7-Pin Receptacle	C1 ⁴ = Integral Slipfitter: Standard	BLCK = Black	F = Fusing
AL= Area Light		H ¹ = 347-480V	Kx = 30000	SW = Symmetric Wide		40 = 4000K	D = External Dimming 18/2 3 ft Cable	D = ANSI C136.417-Pin Receptacle with Shorting Cap	D1 ⁵ = Universal Mounting Arm: Fitted for round or square pole mounting	DKBZ = Dark Bronze	H ⁸ = Motion Sensor (Sensor Switch)
P = Premium		E ^{1,9} = 277-480V	Lx = 35000	SH = Symmetric High Angle		50 = 5000K		E = ANSI C136.41 7-pin with Non-Dimming PE Control ³	K1 ^{4,6} = Knuckle Slipfitter: For 1.9 in. - 2.3 in OD Tenon.	GRAY = Gray	H1 = LightGrid w/ WattStopper
			Mx = 40000	AF = Asymmetric Forward					S1 ^{4,6} = Knuckle Slipfitter: For 2.3 in. - 3.0 in OD Tenon.	WHTE = White	H ^{2,8} = Daintree enabled motion sensor
		1 = 120	Nx = 50000	AH = Asymmetric High Angle					V1 ^{4,6} = Knuckle Wall Mount		H4 = Motion Sensor (WattStopper)
		2 = 208	Px = 60000	AW = Asymmetric Wide							J = cUL/ Canada
		3 = 240	Qx = 70000	AN = Asymmetric Narrow/Auto							L = Tool-Less Entry
		4 = 277									R = Enhanced Surge Protection (10kV/5kA)
		D = 347									S1 ¹² = Rotated Left
		5 = 480									S2 ¹² = Rotated Right
											T = Extreme Surge Protection (20kV/10kA)
											U ^{7,8,13} = DALI Programmable
											V = 3 Position Terminal Block
											Y ¹⁰ = Coastal Finish
											XXX = Special Options

¹ Not Available with Fusing, Must Choose a Discrete Voltage with "F" Option Code

² Note Standard Dimming is 0-10V

³ PE Control only available for 120-277V, 347V or 480V Discrete Voltage.

⁴ Supplied with 3ft leads

⁵ Supplied with 16/3 ft Cable

⁶ Restricted Aiming Angle of 0-45°

⁷ Compatible with LightGrid Wireless Control Nodes, Not Compatible with Motion Sensor Control

⁸ Not available in 347V, 480V or 347-480V

⁹ Only available with H, J, K, L & M optics

¹⁰ Recommended for installations within 750 feet from coast. Lead time varies, check with factory.

¹¹ Select 3000K CCT for IIDA approved fixtures.

¹² For aimed left or right light distribution orientation, as assembled in manufacturing. Not applicable for Symmetric Distributions.

¹³ Not available for 400W and above

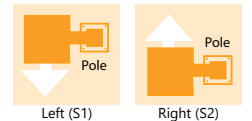

For additional information on EALP files, please click one of the following links:

Evolve[®] EALP Series

LED Area Light

Spec Tables

CUSTOMER NAME

Project Name _____

Date _____ Type _____

Catalog Number _____

TYPE	OPTIC CODE	DISTRIBUTION	TYPICAL INITIAL LUMENS		TYPICAL SYSTEM WATTAGE	BUG RATINGS		IES FILE NUMBER		
			3000K	4000K & 5000K	120-277 & 347-480V	3000K B-U-G	4000 & 5000K B-U-G	3000K	4000K	5000K
Type V	J5	Symmetric Medium (SM)	23600	25000	172	B4-U0-G2	B4-U0-G2	EALP03_J5SM730	EALP03_J5SM740	EALP03_J5SM750
	K5		28300	30000	212	B5-U0-G3	B5-U0-G3	EALP03_K5SM730	EALP03_K5SM740	EALP03_K5SM750
	L5		33000	35000	263	B5-U0-G3	B5-U0-G3	EALP03_L5SM730	EALP03_L5SM740	EALP03_L5SM750
	M5		37800	40000	305	B5-U0-G3	B5-U0-G4	EALP03_M5SM730	EALP03_M5SM740	EALP03_M5SM750
	N5		47200	50000	400	B5-U0-G4	B5-U0-G4	EALP03_N5SM730	EALP03_N5SM740	EALP03_N5SM750
	P5		56700	60000	470	B5-U0-G4	B5-U0-G4	EALP03_P5SM730	EALP03_P5SM740	EALP03_P5SM750
	Q5		66100	70000	570	B5-U0-G5	B5-U0-G5	EALP03_Q5SM730	EALP03_Q5SM740	EALP03_Q5SM750
	J5	Symmetric Wide (SW)	23600	25000	172	B4-U0-G2	B4-U0-G2	EALP03_J5SW730	EALP03_J5SW740	EALP03_J5SW750
	K5		28300	30000	212	B5-U0-G2	B5-U0-G2	EALP03_K5SW730	EALP03_K5SW740	EALP03_K5SW750
	L5		33000	35000	263	B5-U0-G2	B5-U0-G2	EALP03_L5SW730	EALP03_L5SW740	EALP03_L5SW750
	M5		37800	40000	305	B5-U0-G2	B5-U0-G2	EALP03_M5SW730	EALP03_M5SW740	EALP03_M5SW750
	N5		47200	50000	400	B5-U0-G3	B5-U0-G3	EALP03_N5SW730	EALP03_N5SW740	EALP03_N5SW750
	P5		56700	60000	470	B5-U0-G3	B5-U0-G3	EALP03_P5SW730	EALP03_P5SW740	EALP03_P5SW750
	Q5		66100	70000	570	B5-U0-G4	B5-U0-G4	EALP03_Q5SW730	EALP03_Q5SW740	EALP03_Q5SW750
	J5	Symmetric High Angle (SH)	22700	24100	172	B5-U0-G3	B5-U0-G3	EALP03_J5SH730	EALP03_J5SH740	EALP03_J5SH750
	K5		27400	29000	212	B5-U0-G3	B5-U0-G3	EALP03_K5SH730	EALP03_K5SH740	EALP03_K5SH750
	L5		31900	33800	263	B5-U0-G4	B5-U0-G4	EALP03_L5SH730	EALP03_L5SH740	EALP03_L5SH750
	M5		36400	38600	305	B5-U0-G4	B5-U0-G4	EALP03_M5SH730	EALP03_M5SH740	EALP03_M5SH750
	N5		45600	48300	400	B5-U0-G4	B5-U0-G5	EALP03_N5SH730	EALP03_N5SH740	EALP03_N5SH750
	P5		54800	58000	470	B5-U0-G5	B5-U0-G5	EALP03_P5SH730	EALP03_P5SH740	EALP03_P5SH750
	Q5		63800	67600	570	B5-U0-G5	B5-U0-G5	EALP03_Q5SH730	EALP03_Q5SH740	EALP03_Q5SH750

Evolve® EALP Series

LED Area Light

Spec Tables

CUSTOMER NAME _____

Project Name _____

Date _____ Type _____

Catalog Number _____

TYPE	OPTIC CODE	DISTRIBUTION	TYPICAL INITIAL LUMENS		TYPICAL SYSTEM WATTAGE	BUG RATINGS		IES FILE NUMBER		
			3000K	4000K & 5000K	120-277 & 347-480V	3000K	4000 & 5000K	3000K	4000K	5000K
						B-U-G	B-U-G			
Type IV	J4	Asymmetric Forward (AF)	23600	25000	200	B3-U0-G3	B3-U0-G4	EALP03_J4AF730	EALP03_J4AF740	EALP03_J4AF750
	K4		28300	30000	212	B3-U0-G4	B3-U0-G4	EALP03_K4AF730	EALP03_K4AF740	EALP03_K4AF750
	L4		33000	35000	263	B3-U0-G4	B3-U0-G4	EALP03_L4AF730	EALP03_L4AF740	EALP03_L4AF750
	M4		37800	40000	305	B4-U0-G4	B4-U0-G5	EALP03_M4AF730	EALP03_M4AF740	EALP03_M4AF750
	N4		47200	50000	400	B4-U0-G5	B4-U0-G5	EALP03_N4AF730	EALP03_N4AF740	EALP03_N4AF750
	P4		56700	60000	470	B4-U0-G5	B4-U0-G5	EALP03_P4AF730	EALP03_P4AF740	EALP03_P4AF750
	Q4		66100	70000	570	B4-U0-G5	B4-U0-G5	EALP03_Q4AF730	EALP03_Q4AF740	EALP03_Q4AF750
	J4	Asymmetric High Angle (AH)	22700	24100	200	B3-U0-G4	B3-U0-G4	EALP03_J4AH730	EALP03_J4AH740	EALP03_J4AH750
	K4		27400	29000	212	B3-U0-G4	B3-U0-G5	EALP03_K4AH730	EALP03_K4AH740	EALP03_K4AH750
	L4		31900	33800	263	B4-U0-G5	B4-U0-G5	EALP03_L4AH730	EALP03_L4AH740	EALP03_L4AH750
	M4		36400	38600	305	B4-U0-G5	B4-U0-G5	EALP03_M4AH730	EALP03_M4AH740	EALP03_M4AH750
	N4		45600	48300	400	B4-U0-G5	B4-U0-G5	EALP03_N4AH730	EALP03_N4AH740	EALP03_N4AH750
	P4		54800	58000	470	B4-U0-G5	B4-U0-G5	EALP03_P4AH730	EALP03_P4AH740	EALP03_P4AH750
	Q4		63800	67600	570	B5-U0-G5	B5-U0-G5	EALP03_Q4AH730	EALP03_Q4AH740	EALP03_Q4AH750
Type III	J3	Asymmetric Wide (AW)	23600	25000	200	B3-U0-G3	B3-U0-G3	EALP03_J3AW730	EALP03_J3AW740	EALP03_J3AW750
	K3		28300	30000	212	B3-U0-G3	B3-U0-G3	EALP03_K3AW730	EALP03_K3AW740	EALP03_K3AW750
	L3		33000	35000	263	B3-U0-G3	B4-U0-G3	EALP03_L3AW730	EALP03_L3AW740	EALP03_L3AW750
	M3		37800	40000	305	B4-U0-G3	B4-U0-G4	EALP03_M3AW730	EALP03_M3AW740	EALP03_M3AW750
	N3		47200	50000	400	B4-U0-G4	B4-U0-G4	EALP03_N3AW730	EALP03_N3AW740	EALP03_N3AW750
	P3		56700	60000	470	B5-U0-G4	B5-U0-G4	EALP03_P3AW730	EALP03_P3AW740	EALP03_P3AW750
	Q3		66100	70000	570	B5-U0-G5	B5-U0-G5	EALP03_Q3AW730	EALP03_Q3AW740	EALP03_Q3AW750
Type II	J2	Asymmetric Narrow/Auto (AN)	23800	25200	200	B3-U0-G3	B3-U0-G3	EALP03_J2AN730	EALP03_J2AN740	EALP03_J2AN750
	K2		28600	30300	212	B3-U0-G3	B3-U0-G3	EALP03_K2AN730	EALP03_K2AN740	EALP03_K2AN750
	L2		33000	35300	263	B4-U0-G4	B4-U0-G4	EALP03_L2AN730	EALP03_L2AN740	EALP03_L2AN750
	M2		38100	40400	305	B4-U0-G4	B4-U0-G4	EALP03_M2AN730	EALP03_M2AN740	EALP03_M2AN750
	N2		47700	50500	400	B4-U0-G4	B4-U0-G4	EALP03_N2AN730	EALP03_N2AN740	EALP03_N2AN750
	P2		57200	60600	470	B4-U0-G4	B4-U0-G4	EALP03_P2AN730	EALP03_P2AN740	EALP03_P2AN750
	Q2		66800	70700	570	B5-U0-G5	B5-U0-G5	EALP03_Q2AN730	EALP03_Q2AN740	EALP03_Q2AN750

Evolve® EALP Series

LED Area Light

Photometric Plots

CUSTOMER NAME

Project Name _____

Date _____ Type _____

Catalog Number _____

EALP03 ASYMMETRIC NARROW (Q2AN750)

70700 Lumens

5000k

EALP03_Q2AN750____.IES

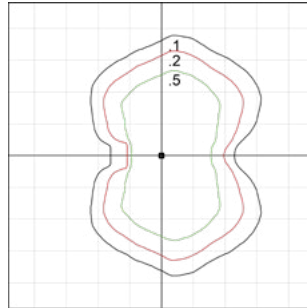

Gridline spacing is equal to mounting height. Initial footcandle values shown are at grade for 40' mounting height.

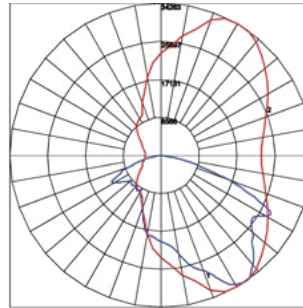

— : Vertical plane through horizontal angle of maximum candlepower at 60°
— : Vertical plane through horizontal angle 35°

EALP03 ASYMMETRIC WIDE (Q3AW750)

70000 Lumens

5000k

EALP03_Q3AW750____.IES

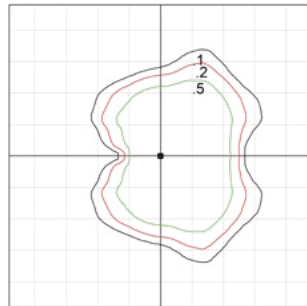

Gridline spacing is equal to mounting height. Initial footcandle values shown are at grade for 40' mounting height.

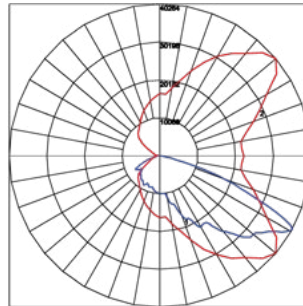

— : Vertical plane through horizontal angle of maximum candlepower at 40°
— : Vertical plane through horizontal angle 61°

EALP03 ASYMMETRIC FORWARD (Q4AF750)

70000 Lumens

5000k

EALP03_Q4AF750____.IES

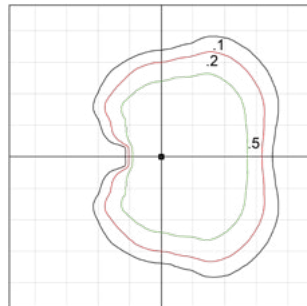

Gridline spacing is equal to mounting height. Initial footcandle values shown are at grade for 40' mounting height.

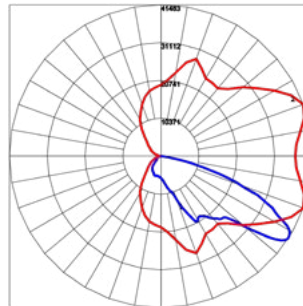

— : Vertical plane through horizontal angle of maximum candlepower at 20°
— : Vertical plane through horizontal angle 57°

EALP03 ASYMMETRIC FORWARD HIGH ANGLE (Q4AH750)

67600 Lumens

5000k

EALP03_Q4AH750____.IES

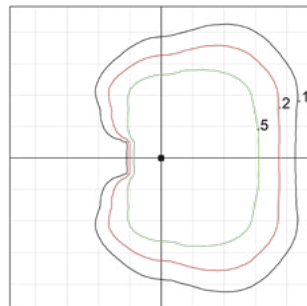

Gridline spacing is equal to mounting height. Initial footcandle values shown are at grade for 40' mounting height.

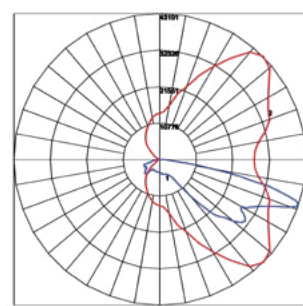

— : Vertical plane through horizontal angle of maximum candlepower at 45°
— : Vertical plane through horizontal angle 72°

Evolve® EALP Series

LED Area Light

Photometric Plots

CUSTOMER NAME

Project Name _____

Date _____ Type _____

Catalog Number _____

EALP03 SYMMETRIC HIGH ANGLE (Q5SH750)

67600 Lumens

5000k

EALP03_Q5SH750____.IES

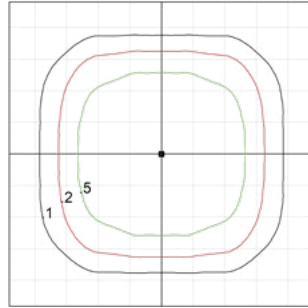

Gridline spacing is equal to mounting height. Initial footcandle values shown are at grade for 40' mounting height.

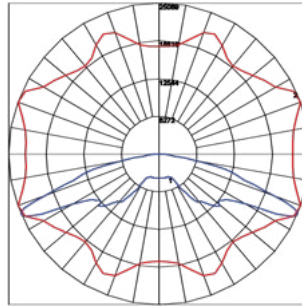

—: Vertical plane through horizontal angle of maximum candlepower at 20°
—: Vertical plane through horizontal angle 66°

EALP03 SYMMETRIC MEDIUM (Q5SM750)

70000 Lumens

5000k

EALP03_Q5SM750____.IES

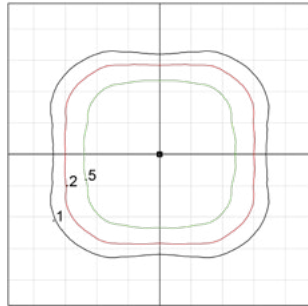

Gridline spacing is equal to mounting height. Initial footcandle values shown are at grade for 40' mounting height.

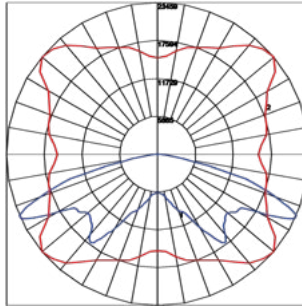

—: Vertical plane through horizontal angle of maximum candlepower at 40°
—: Vertical plane through horizontal angle 65°

EALP03 SYMMETRIC WIDE (Q5SW750)

70000 Lumens

5000k

EALP03_Q5SW750____.IES

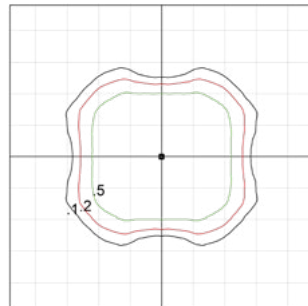

Gridline spacing is equal to mounting height. Initial footcandle values shown are at grade for 40' mounting height.

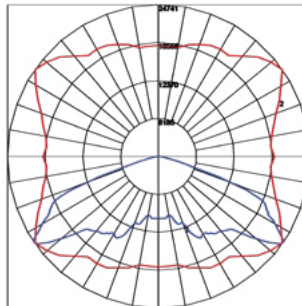

—: Vertical plane through horizontal angle of maximum candlepower at 35°
—: Vertical plane through horizontal angle 56°

Evolve® EALP Series

LED Area Light

Motion Sensing

CUSTOMER NAME

Project Name _____

Date _____ Type _____

Catalog Number _____

H-MOTION SENSING OPTION

- Recommended Mounting Height: 15-30' (4.6-9.1m)
- For mounting heights exceeding 30 ft., pole mounted sensors are recommended
- Coverage Radius: 15-20' (4.6-6.1 m).
- Provides 270 degree of coverage (approx 90 is blocked by the pole)
- Default Settings:
 - Output: Occupied - 100%/Unoccupied - 50%
 - Integral PE Sensor.
 - 5 minute post-occupancy time delay, 5 minute dimming ramp-down.
- Fixture power increase of 1W expected with sensor use.

Note: Standard options may be reprogrammed in the field. Reprogramming instructions included in product shipment

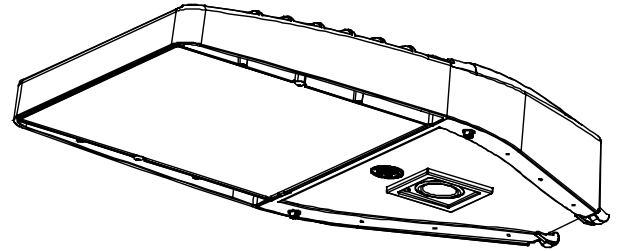

H1/4 - MOTION SENSING OPTION (WATTSTOPPER)

- Recommended Mounting Height: 15-30' (4.6-9.1m)
- For mounting heights exceeding 30 ft., pole mounted sensors are recommended
- Coverage Radius: 15-20' (4.6-6.1 m).
- Provides 270 degree of coverage (approx 90 is blocked by the pole)
- Default Settings:
 - Output: Occupied - 100%/Unoccupied - 50%
 - PE Sensor: Enabled
 - Ramp/Fade: 5 Minutes/5 Minutes
- Adds < 1W to fixture power rating
- Field programmable using FSIR-100 hand held programmer

Note: Standard options may be reprogrammed in the field. Reprogramming instructions included in product shipment

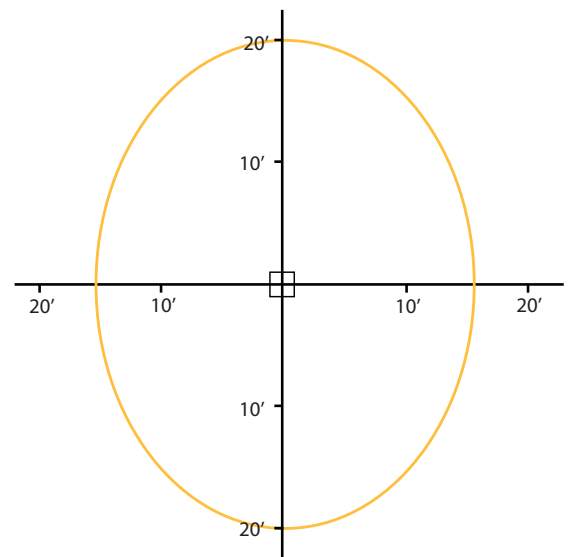

H2 - MOTION SENSING OPTION (DAINTREE)

- Recommended Mounting Height: 15-30' (4.6-9.1m)
- For mounting heights exceeding 30 ft., pole mounted sensors are recommended
- Provides a coverage area radius for walking motion of 15-20 ft. (4.57-6.10m)
- Provides 270 degree of coverage (approx 90 is blocked by the pole)
- Default Settings:
 - Output: Occupied - 100%/Unoccupied - 50%
 - PE Sensor: None
 - Ramp/Fade: 5 Minutes/5 Minutes
- Adds < 1W to fixture power rating
- Requires Daintree Enterprise and wide area control (WAC)

Sensing Pattern Area Fixture
Up to 30 ft. Mounting Height

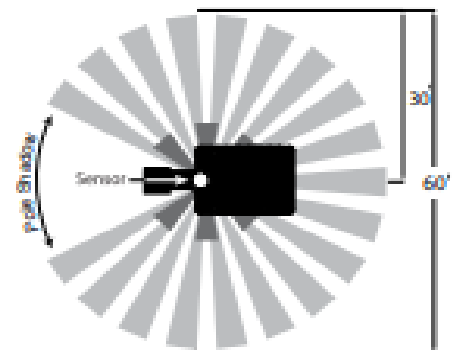

Evolve® EALP Series

LED Area Light

Mounting & Accessories

CUSTOMER NAME _____

Project Name _____

Date _____ Type _____

Catalog Number _____

INTEGRAL SLIPFITTER: C1

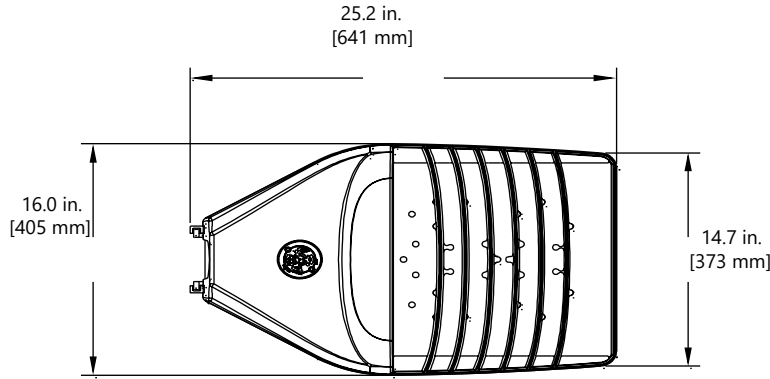

TOP VIEW

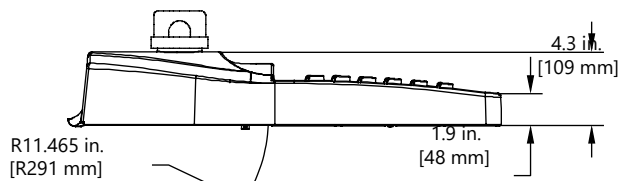

SIDE VIEW

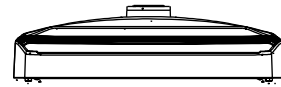
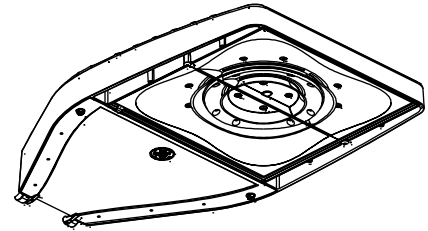

FRONT VIEW

KNUCKLE SLIPFITTER: S1

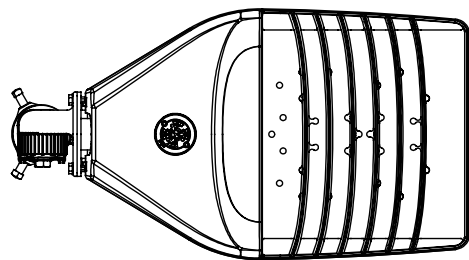

TOP VIEW

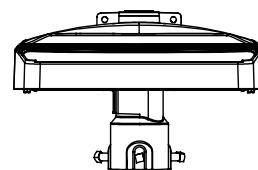
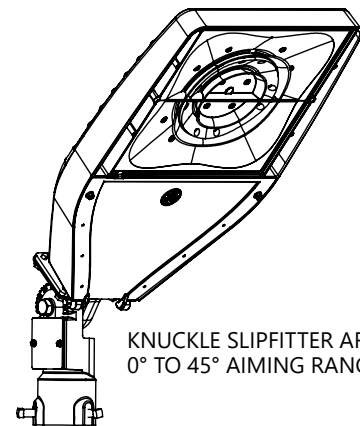
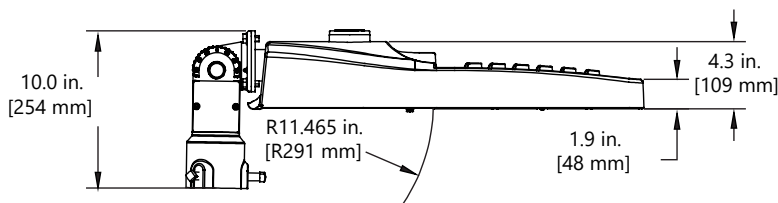

Evolve® EALP Series

LED Area Light

Mounting & Accessories

CUSTOMER NAME _____

Project Name _____

Date _____ Type _____

Catalog Number _____

UNIVERSAL ARM MOUNT: D1

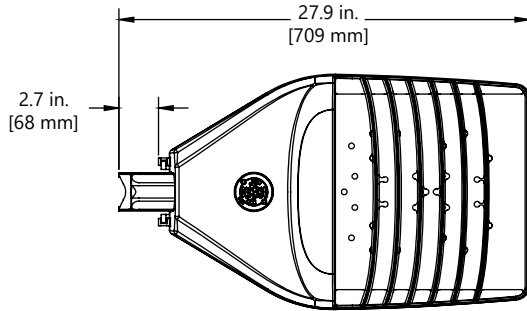

TOP VIEW

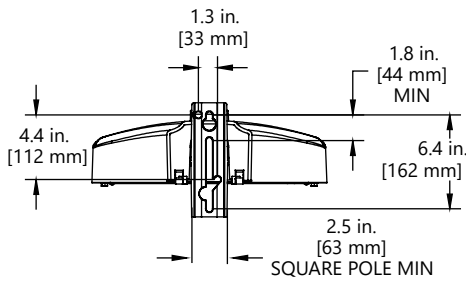
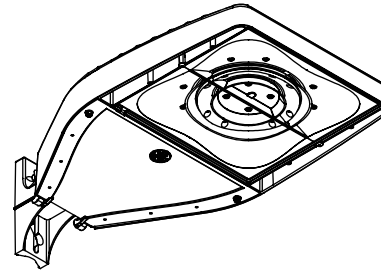

BACK VIEW

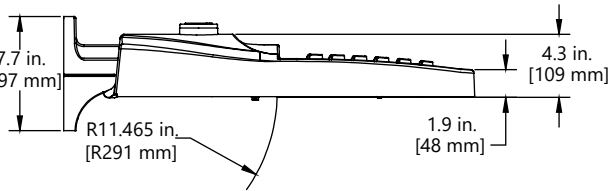

SIDE VIEW

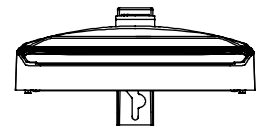

FRONT VIEW

KNUCKLE WALL MOUNT: V1

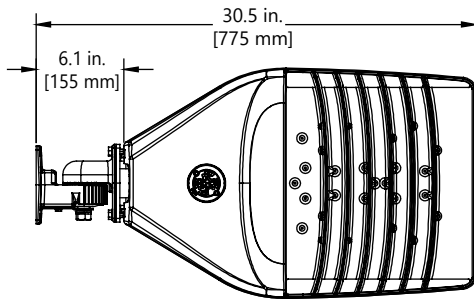

TOP VIEW

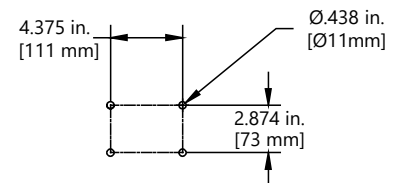
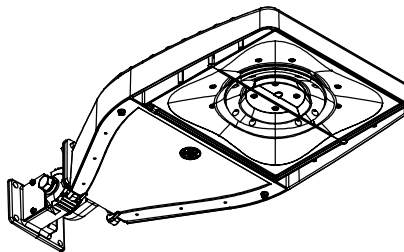

Wall Mount Hole Pattern

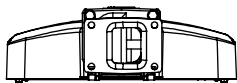

BACK VIEW

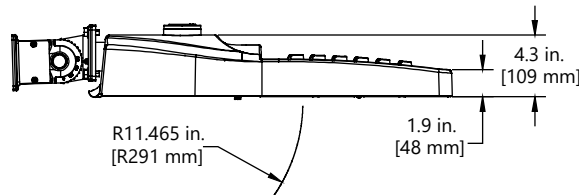

SIDE VIEW

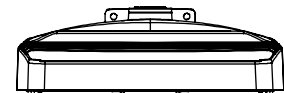

FRONT VIEW

DATA

- Approximate Net Weight: 26-28 lbs (11.79 kgs-12.97 kgs)
- Effective Projected Area (EPA):
 - Knuckle Slipfitter S1, 45° aim, EPA = 2.45
 - Knuckle w/Slipfitter S1, downward aim, EPA = 0.73
 - Universal Arm Mount D1, EPA = 0.54
 - Knuckle Wall Mount V1, 45° aim, EPA = 0.77 sq ft min and 1.43 sq ft max
 - Integral Slipfitter C1, EPA = 0.63

Evolve® EALP Series

LED Area Light

Mounting & Accessories

CUSTOMER NAME

Project Name _____

Date _____ Type _____

Catalog Number _____

MOUNTING ARMS FOR SLIPFITTER

Order separately with Mounting Option C1 (Slipfitter)

SQUARE POLE MOUNTING ARM

3.5 TO 4.5-inch (89 to 114mm) SQUARE
(WILL ALLOW 4 FIXTURES PER POLE @ 90 DEGREES.)

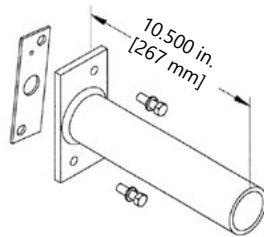

ORDER SEPARATELY FROM FIXTURE AS CATALOG NUMBER
SPA-EAMT10BLCK "Black"
SPA-EAMT10DKBZ "Dark Bronze"

SQUARE POLE MOUNTING DRILLING TEMPLATE

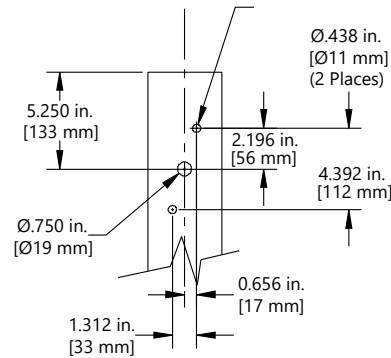

ROUND POLE MOUNTING ARM DRILLING TEMPLATE

3.5 TO 4.5-inch (89 to 114mm) OD
(WILL ALLOW 4 FIXTURES PER POLE @ 90 DEGREES.)

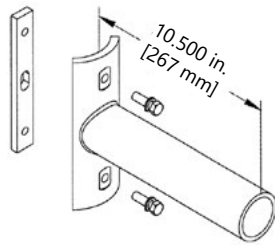

ORDER SEPARATELY FROM FIXTURE AS CATALOG NUMBER
RPA-EAMT10BLCK "Black"
RPA-EAMT10DKBZ "Dark Bronze"

ROUND POLE MOUNTING DRILLING TEMPLATE

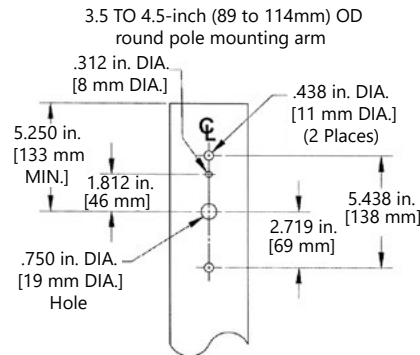

Wall Mounting Bracket Adapter Plate

ORDER SEPARATELY FROM FIXTURE AS CATALOG NUMBER

WMB-EAMT06

*NOTE: For Wall Mounting, order luminaire with mounting arm: C1 = Slipfitter 2" Pipe (2.378 in. OD) supplied with leads.

**Other mounting patterns are available for retrofit installations.
Contact manufacturing for other available mounting patterns.**

SAP NUMBER	PART NUMBER	DESCRIPTION
93123552	WANSI - 277	ANSI 136.41 Dimming PE Daintree Enable, 105-305V
93123553	WANSI - 480	ANSI 136.41 Dimming PE Daintree Enable, 312-530V
93029237	PED-MV-LED-7	ANSI C136.41 Dimming PE, 120-277V
93029238	PED-347-LED-7	ANSI C136.41 Dimming PE, 347V
93029239	PED-480-LED-7	ANSI C136.41 Dimming PE, 480V

SAP NUMBER	PART NUMBER	DESCRIPTION
28299	PECOTL	Standard 120-277V
28294	PECSTL	Standard 480V
80436	PECDTL	Standard 347V
93147530	PECHTL	Long Life Standard PE, 347-480V
73251	SCCL-PECTL	Shorting Cap
93029239	PED-480-LED-7	ANSI C136.41 Dimming PE, 480V

PE Accessories (to be ordered separately)