

# Electronic Sign Ballasts

## Specifications Guide

### Warranty

Allanson Lighting Components provides a 4 year warranty on Electronic Sign Ballasts. Extend your warranty for another year (5 years) when you purchase Allanson H.O. Sockets. For more information, please contact customer service.

### USA

801 Space Park North  
Goodlettsville, TN, 37072

 [csupport@allanson.com](mailto:csupport@allanson.com)

 1.800.559.3659

 615.855.0592

### Canada

33 Cranfield Road  
Toronto, ON, M4B 3H2

 [cservice@allanson.com](mailto:cservice@allanson.com)

 1.800.661.7251

 416.752.6717



## Specifications Charts

RSS Series Electronic Sign Ballasts Minimum starting temperature is -20°F (-30°C).  
For use with T12 HO, T8 HO, and Slimline Lamps 120 Volts, 50/60Hz

For 800mA T12/HO Lamps Standard								
No. of Lamps	Footage Min.	Footage Max.	Catalog Number	Input Voltage	Max Input Amps	Max Input Watts	Open Circuit Voltage	Wiring Diagram
1 to 2	4'	16'	RSS296AT*	120V	1.60	190	950	1,2
2 to 4	8'	32'	RSS496AT**	120V	3.20	370	950	3-5
4 to 6	24'	48'	RSS696AT***	120V	4.15	490	950	6-8

For 800mA T8/HO Lamps Standard								
No. of Lamps	Footage Min.	Footage Max.	Catalog Number	Input Voltage	Max Input Amps	Max Input Watts	Open Circuit Voltage	Wiring Diagram
1 to 2	4'	12'	RSS296AT	120V	1.45	176	950	1,2
2 to 4	8'	24'	RSS496AT	120V	3.10	362	950	3-5
4 to 6	18'	36'	RSS696AT	120V	4.10	478	950	6-8

\*For use with 1 10' lamp. \*\*For use with 2 10' lamps. \*\*\*For use with 4 10' lamps.

## RSS Ballast Footage Chart

CAT#	T8/T12	# of lamps	Total Lamp Footage Range (Feet)																																																				
			1	2	3	4	5	6	7	8	9	10	11	12	13	14	15	16	17	18	19	20	21	22	23	24	25	26	27	28	29	30	31	32	33	34	35	36	37	38	39	40	41	42	43	44	45	46	47	48	49	50			
RSS296AT	T8	1-2																																																					
	T12	1-2																																																					
RSS496AT	T8	2-4																																																					
	T12	2-4																																																					
RSS696AT	T8	4-6																																																					
	T12	4-6																																																					

## Dimensions and Weights

CAT #	Lead Length (Feet)				Dimensions (inches)				Weight (lb)
	Black	White	Red	Blue	Length	Width	Height	Mounting	
RSS296AT	2.5	2.5	11	11	11-3/4	3-3/16	1-25/32	11.125	5
RSS496AT	2.5	2.5	11	11	14-7/16	3-3/16	2-5/8	13.813	10.5
RSS696AT	2.5	2.5	11	11	16-1/2	3-3/16	2-5/8	15.947	10.5

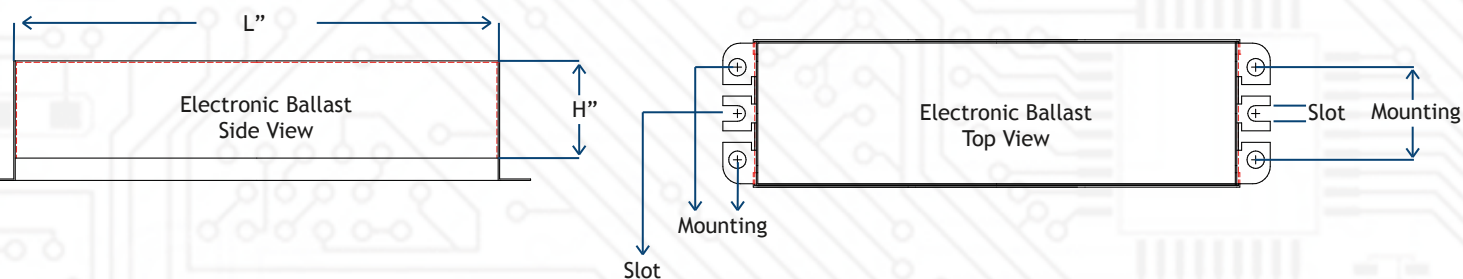

## RSS Installation Wiring Diagrams\*

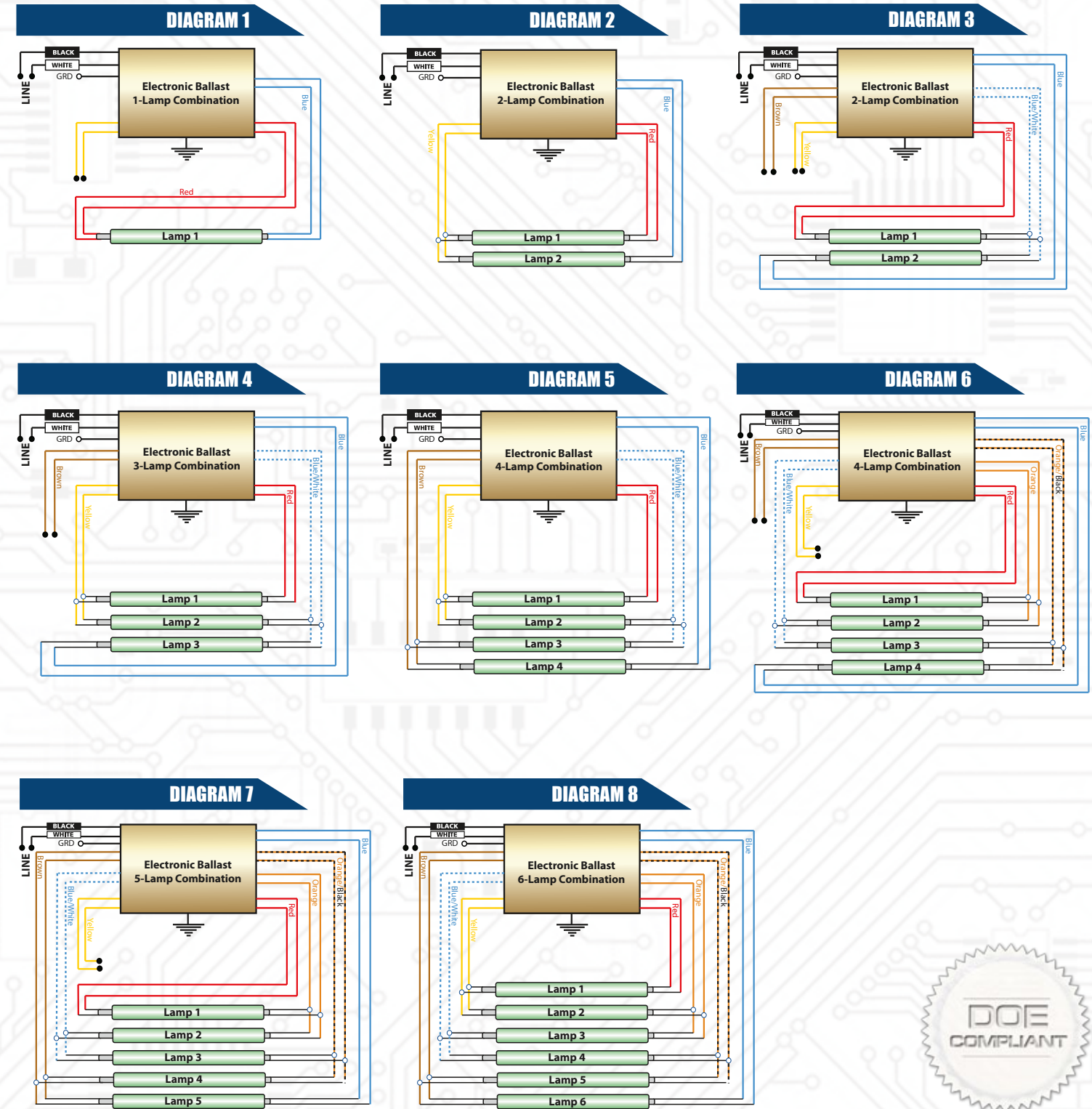

\*RSS Diagrams above can easily be used in both new installation and magnetic to electronic replacement applications. All ballasts must be grounded.

# EESB Parallel Wired Electronic Ballasts

## Specifications Charts

EESB Series Electronic Sign Ballasts Minimum starting temperature is -20°F (-30°C).

For use with T12 HO, T8 HO, and Slimline Lamps 120 Volts, 50/60Hz

For 800mA T12/HO Lamps Standard								
No. of Lamps	Footage		Catalog Number	Input Voltage	Max Input Amps	Max Input Watts	Open Circuit Voltage	Wiring Diagram
	Min.	Max						
1	18"	8'	EESB-1808-1L	120V	0.85	100	800	1,7
1 to 3	4'	24'	EESB-424-13L	120V	1.50	180	750	3,9
1 to 6	8'	32'	EESB-832-16L	120V	2.40	282	800	4,10
1 to 4	10'	40'	EESB-1040-14L *	120V	2.70	328	850	5,11
2 to 6	10'	48'	EESB-1048-26L***	120V	3.00	355	800	6,12

For use with T12 HO, T8 HO, and Slimline Lamps 120/220/240/277 Volts, 50/60Hz

For 800mA T12/HO Lamps Standard								
No. of Lamps	Footage		Catalog Number	Input Voltage	Max Input Amps	Max Input Watts	Open Circuit Voltage	Wiring Diagram
	Min.	Max						
1 to 2	2'	16'	EESB-0216-12L 120-277V	120V	1.20	134	980	2-8
				208V	0.64	133		
				240V	0.58	135		
				277V	0.55	136		
1 to 4	4'	32'	EESB-0432-14L 120-277V	120V	2.35	271	980	5-11
				208V	1.30	270		
				240V	1.18	271		
				277V	1.10	272		
1 to 6	2'	50'	EESB-0250-16L 120-277V**	120V	3.54	410	980	6-12
				208V	1.96	404		
				240V	1.67	402		
				277V	1.48	402		
2 to 6	10'	48'	EESB-1048-26L 120-277V*	120V	3.10	362	980	6-12
				208V	1.76	361		
				240V	1.54	361		
				277V	1.32	360		

For use with T12 HO, T8 HO, T8 50K hours Long Life Lamps, and Slimline Lamps 120/220/240/277 Volts 50/60/Hz

For 315mA T8 Long Life Lamp								
No. Of Lamps	Footage		Catalog Number	Input Voltage	Max Input Amps	Max Input Watts	Open Circuit Voltage	Wiring Diagram
	Min.	Max						
1 to 6	2'	48'	EESB-0250-16L 120-277V	120V	3.55	418	980	6-12
				208V	2.01	416		
				240V	1.76	416		
				277V	1.55	416		

For use with T12 HO, T8 HO, T8 18K hours Medium Life, and Slimline Lamps 120/220/240/277 Volts 50/60/Hz

For 375mA T8 HO Medium Life Lamps								
No. Of Lamps	Footage		Catalog Number	Input Voltage	Max Input Amps	Max Input Watts	Open Circuit Voltage	Wiring Diagram
	Min.	Max						
1 to 2	2'	12'	EESB-0216-12L 120-277V	120V	1.10	124	980	2-8
				208V	0.61	124		
				240V	0.53	125		
				277V	0.50	125		
1 to 4	4'	24'	EESB-0432-14L 120-277V	120V	2.25	247	980	5-11
				208V	1.19	248		
				240V	1.04	248		
				277V	1.00	249		
1 to 6	2'	48'	EESB-0250-16L 120-277V	120V	3.65	427	980	6-12
				208V	2.08	427		
				240V	1.82	428		
				277V	1.58	428		
2 to 6	10'	48'	EESB-1048-26L 120-277V*	120V	3.65	427	980	6-12
				208V	2.08	427		
				240V	1.82	428		
				277V	1.58	428		

\*For use with up to 4 10' lamps  
 \*\*For use with up to 5 10' lamps  
 \*\*\*DO NOT use 10' lamps

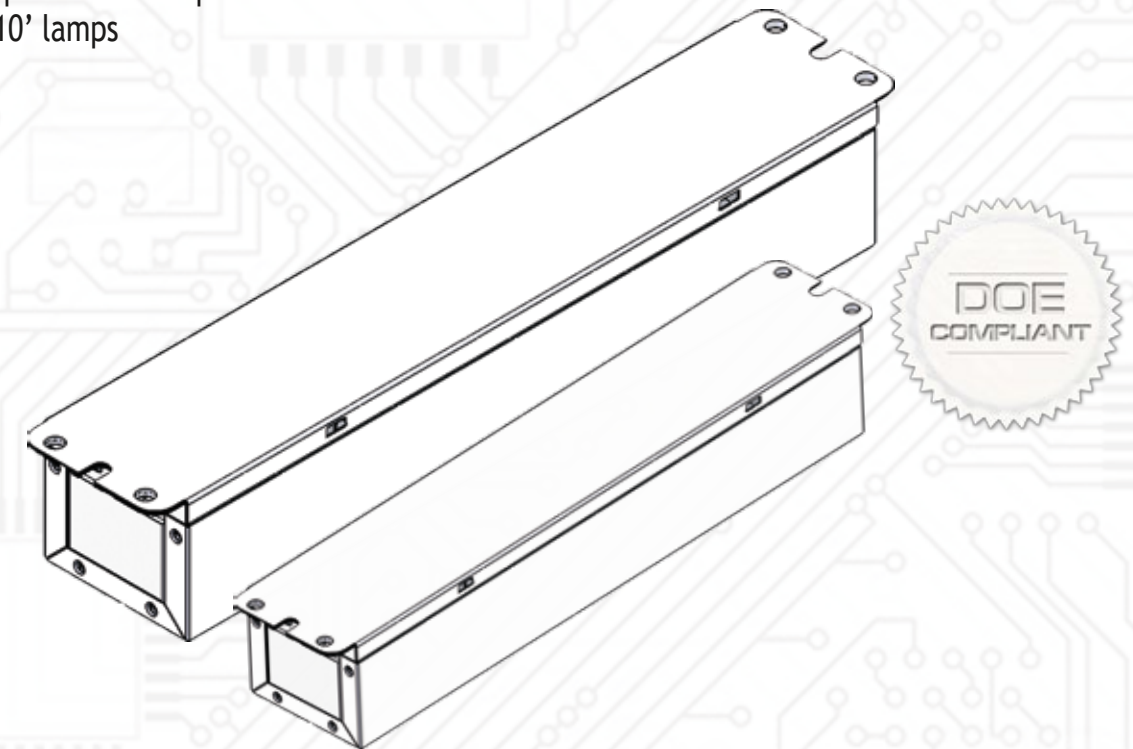

# EESB Parallel Wired Electronic Ballasts

## EESB Ballast Footage Chart

CAT #	T8/T12	# of lamps	Total Lamp Footage Range (Feet)																																														
			1	2	3	4	5	6	7	8	9	10	11	12	13	14	15	16	17	18	19	20	21	22	23	24	25	26	27	28	29	30	31	32	33	34	35	36	37	38	39	40	41	42	43	44	45	46	47
EESB-1801-1L	T8	1	EESB-1808-1L (T8)																																														
	T12	1	EESB-1808-1L (T12)																																														
EESB-424-13L	T8	1-3	EESB-424-13L (T8)																																														
	T12	1-3	EESB-424-13L (T12)																																														
EESB-832-16L	T8	1-6	EESB-832-16L (T8)																																														
	T12	1-6	EESB-832-16L (T12)																																														
EESB-1040-14L	T8	1-4	EESB-1040-14L (T8)																																														
	T12	1-4	EESB-1040-14L (T12)																																														
EESB-1048-26L	T8	2-6	EESB-1048-26L (T8)																																														
	T12	2-6	EESB-1048-26L (T12)																																														
EESB-0216-12L 120-277V	T8	1-2	EESB-0216-12L 120-277V (T8)																																														
	T12	1-2	EESB-0216-12L 120-277V (T12)																																														
EESB-0432-14L 120-277V	T8	1-4	EESB-0432-14L 120-277V (T8)																																														
	T12	1-4	EESB-0432-14L 120-277V (T12)																																														
EESB-0250-16L 120-277V	T8	1-6	EESB-0250-16L 120-277V (T8)																																														
	T12	1-6	EESB-0250-16L 120-277V (T12)																																														
	T8 Long Life	1-6	EESB-0250-16L 120-277V (T8 Long Life)																																														
EESB-1048-26L 120-277V	T8	2-6	EESB-1048-26L 120-277V (T8)																																														
	T12	2-6	EESB-1048-26L 120-277V (T12)																																														

## Dimensions and Weights

CAT #	Lead Length (Feet)				Dimensions (inches)			Mounting	Weight (lb)
	Black	White	Red	Blue	Length	Width	Height		
EESB-1808-1L	2.5	2.5	11	11	9-1/2	2-3/8	1-5/8	8-7/8	2
EESB-424-13L	2.5	2.5	11	11	11-3/4	3	1-3/4	11-1/8	5
EESB-832-16L	2.5	2.5	11	11	14-7/16	3	2-3/4	13-3/4	8
EESB-1040-14L	2.5	2.5	11	11	14-7/16	3	2-3/4	13-3/4	8
EESB-1048-26L	2.5	2.5	11	11	14-7/16	3	2-3/4	13-3/4	8
EESB-0216-12L 120-277V	2.5	2.5	11	11	9-1/2	2-3/8	1-5/8	8-7/8	2.5
EESB-0432-14L 120-277V	2.5	2.5	11	11	14-7/16	3	2-3/4	13-3/4	9.5
EESB-0250-16L 120-277V	2.5	2.5	11	11	14-7/16	3	2-3/4	13-3/4	8
EESB-1048-26L 120-277V	2.5	2.5	11	11	14-7/16	3	2-3/4	13-3/4	9

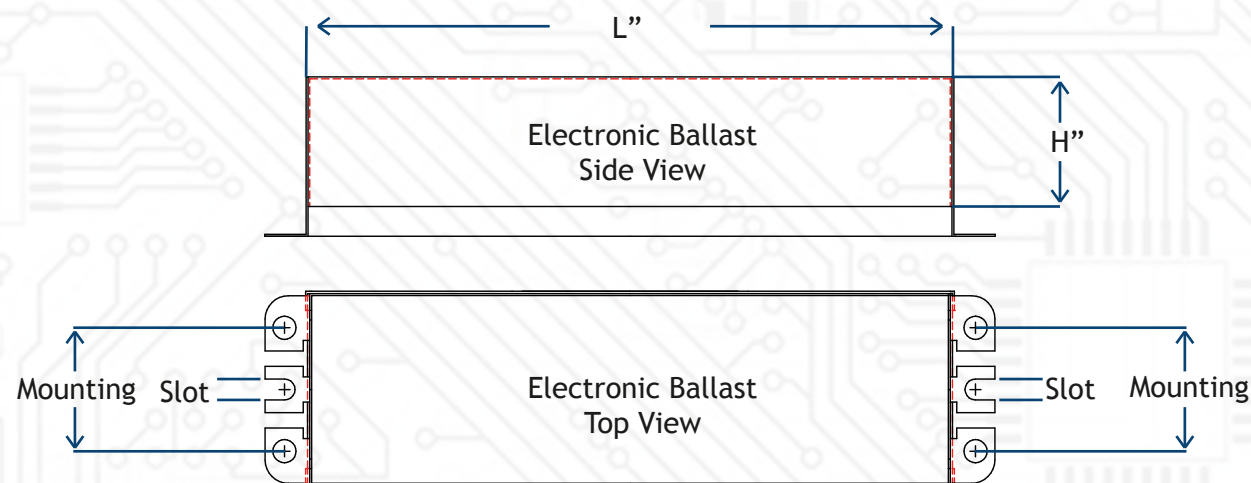

## EESB New Installation Wiring Diagrams

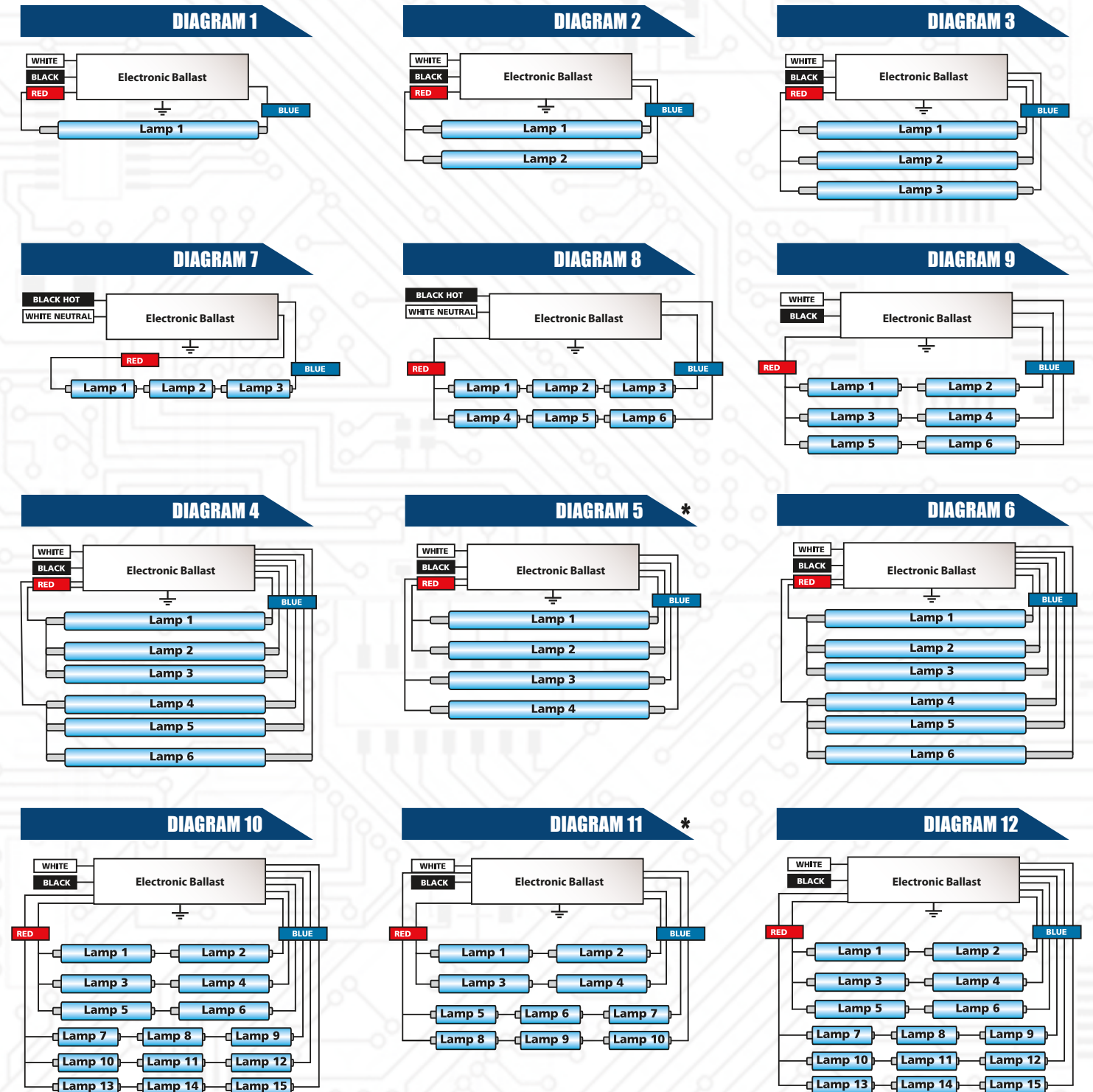

\*Designed for use with lamps up to 10' in length.

Wiring diagrams for Allanson Lighting Components' EESB Electronic Ballasts are simpler, with half the connections found in old-style magnetics. Lamps are parallel wired, so if one burns out the others keep working. All ballasts must be grounded.

## EESB Magnetic to Electronic Re-Wiring Diagrams

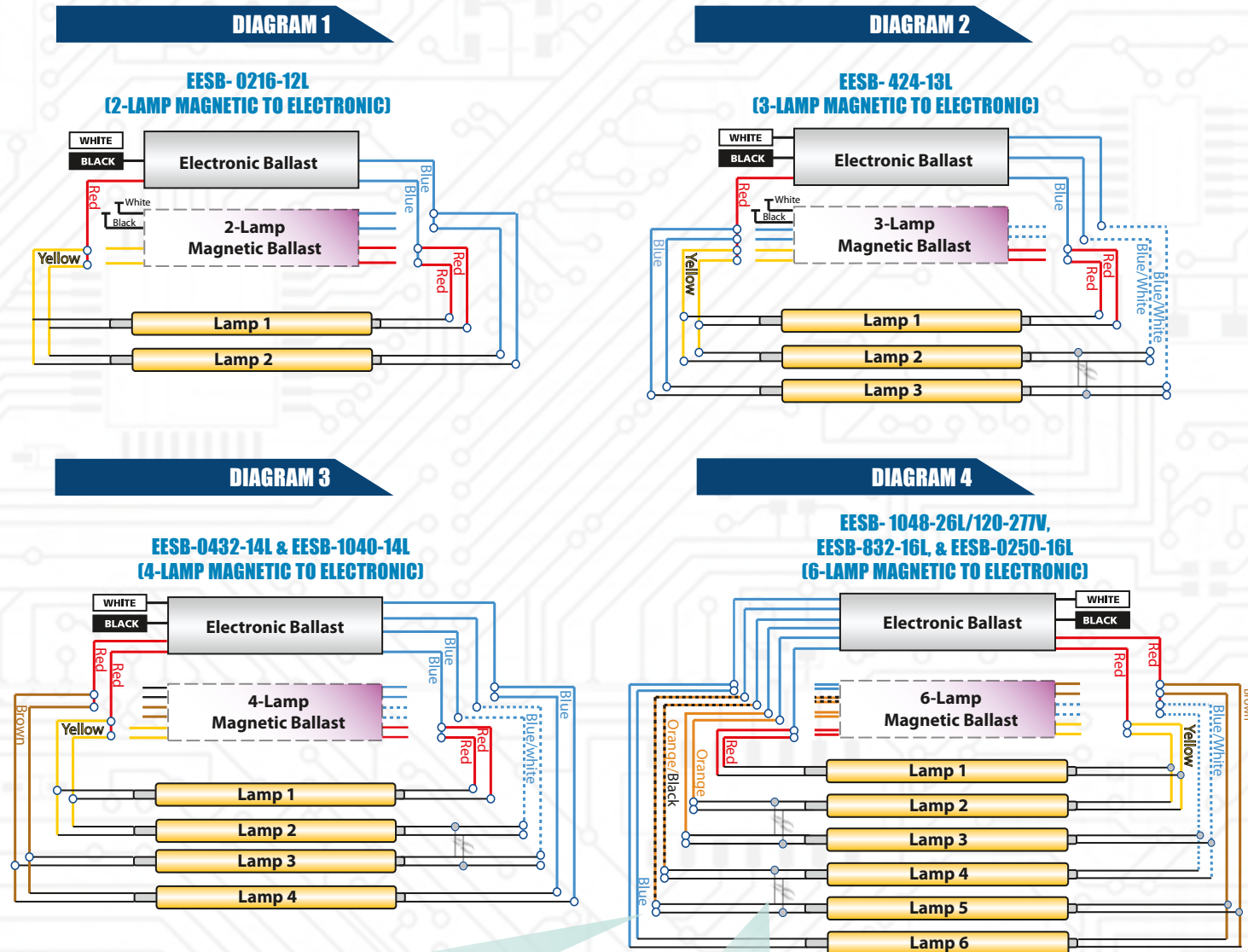

Symbol indicates to join two lamp socket wires together and then to connect to one wire (blue or red).



Symbol indicates cutting of jumper wires to disconnect the parallel connection of lamp sockets.

For a live demonstration, watch our [Magnetic to Electronic Replacement Video](#).

Visit [www.allanson.com](http://www.allanson.com)

## Tombstone Lamp Holders

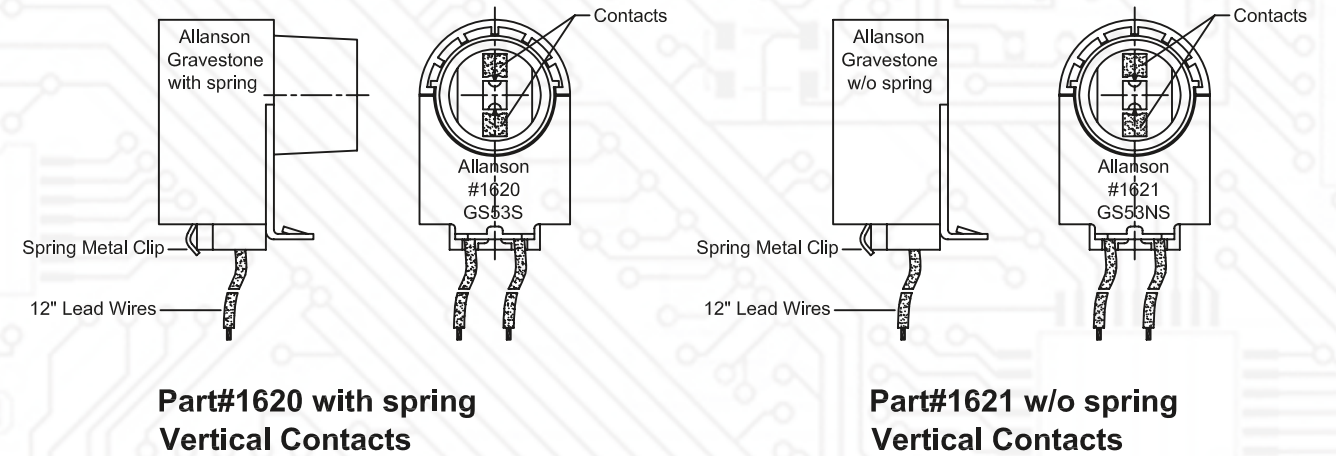

## Flush Mount Lamp Holders

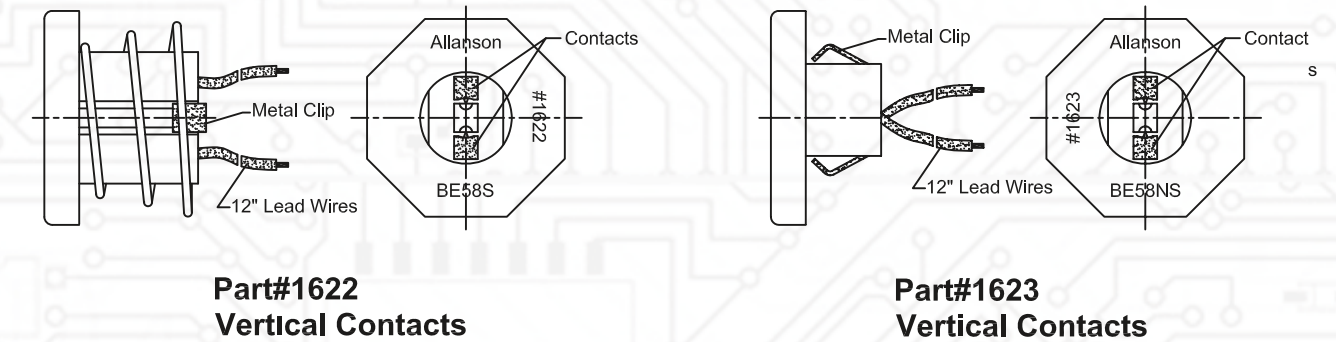

Lamp holder Ratings: 660W, 600V / 1000V rating

Materials: GE® resins, Ni plated steels, stainless steels, “O” ring, and tin bronze contacts were used in the manufacturing of Allanson lamp holders. The 12” lead assemblies are stranded 18AWG tinned copper and have 1015/1032 UL ratings 221°F (105°C) and 1000V.

Mounting: High strength metal retaining clips ensure solid hold when installed per specifications.

Mounting “D” Hole:

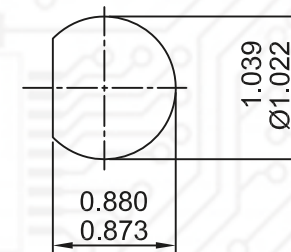

cULus listed.  
UL listed for use  
in U.S.A and Canada.





Magnetic Ballasts					Electronic Replacement				
Allanson	Universal	France	Advance		Transco	Footage		RSS	EESB
148-AT	256-148-800	168 DR			TRA-148-0204	2' - 4'		RSS296AT	EESB-1808-1L / EESB-0216-12L-120-277V
196-AT	---	268 DR			---	18" - 8'		RSS296AT	EESB-1808-1L / EESB-0216-12L-120-277V
224-AT	---	268 DR			TRA-224-0204	4" - 8"		RSS296AT	EESB-0216-12L-120-277V
---	256-248-800				---	2' - 4'		RSS296AT	EESB-0216-12L-120-277V
272-AT	256-272-800	268 DR	ASB-0412-12-BL-TP		TRA-272-0612	4' - 12'		RSS296AT	EESB-424-13L / EESB-0216-12L-120-277V
296-AT	256-296-800	288 DR			TRA-296-0816	12' - 16'		RSS296AT	EESB-424-13L / EESB-0216-12L-120-277V
348-AT	256-348-800	348 DR			TRA-348-0412	6' - 12'			EESB-424-13L / EESB-0216-12L-120-277V
372-AT	256-372-800	368 DR			---	6' - 12'			EESB-424-13L / EESB-0216-12L-120-277V
	---	2128 DR			TRA-2120-1020	10' - 20'		RSS496AT	EESB-1040-14L / EESB-1048-26L-120-277V
396-AT	256-396-800	388 DR			TRA-396-1624	18' - 24'		RSS496AT	EESB-424-13L / EESB-0432-14L-120-277V
448-AT	256-448-800	448 DR	ASB-0620-24-BL-TP		TRA-448-0816	8' - 18'		RSS496AT	EESB-424-13L / EESB-0432-14L-120-277V
---	256-464-800	---			---	16' - 24'		RSS496AT	EESB-424-13L / EESB-0432-14L-120-277V
472-AT	256-472-800	468 DR	ASB-1224-24-BL-TP		TRA-472-1624	16' - 24'		RSS496AT	EESB-424-13L / EESB-0432-14L-120-277V
496-AT	256-496-800	488 DR	ASB-2432-34-BL-TP		TRA-496-2432	24' - 32'		RSS496AT	EESB-832-16L / EESB-0432-14L-120-277V
4120-AT	256-4120-800	4128 DR	ASB-2040-24-BL-TP		TRA-4120-2040	20' - 40'		RSS696AT	EESB-1040-14L / EESB-1048-26L-120-277V
572-AT	---	568 DR			---	20' - 30'		RSS696AT	EESB-832-16L / EESB-1048-26L-120-277V
648-AT	256-648-800	668 DR			TRA-648-1624	8' - 24'			EESB-832-16L / EESB-1048-26L-120-277V
672-AT	256-672-800	668 DR	ASB-1240-46-BL-TP		TRA-672-2436	24' - 36'		RSS696AT	EESB-1048-26L / EESB-1048-26L-120-277V
696-AT	256-696-800	688 KR	ASB-2448-46-BL-TP		TRA-696-3048	30' - 48'		RSS696AT	EESB-1048-26L / EESB-1048-26L-120-277V
148-AT-277V		168 KR				2' - 4'		---	EESB-0216-12L-120-277V
196-AT-277V		268 KR				18" - 8'		---	EESB-0216-12L-120-277V
272-AT-277V		268 KR				4' - 12'		---	EESB-0216-12L-120-277V
296-AT-277V		288 KR				12' - 16'		---	EESB-0216-12L-120-277V
348-AT-277V		348 KR				6' - 12'		---	EESB-0432-14L-120-277V
372-AT-277V		368 KR				6' - 12'		---	EESB-0432-14L-120-277V
396-AT-277V		388 KR				18' - 24'		---	EESB-0432-14L-120-277V
448-AT-277V		448 KR				8' - 18'		---	EESB-0432-14L-120-277V
472-AT-277V		468 KR				16' - 24'		---	EESB-0432-14L-120-277V
496-AT-277V	256-1588-800	488 KR				24' - 32'		---	EESB-0432-14L-120-277V
4120-AT-277V		4128 KR				20' - 40'		---	EESB-1048-26L-120-277V
572-AT-277V		568 KR				20' - 30'		---	EESB-1048-26L-120-277V
648-AT-277V		668 KR				8' - 24'		---	EESB-1048-26L-120-277V
672-AT-277V		668 KR				24' - 36'		---	EESB-1048-26L-120-277V
696-AT-277V		688 KR				30' - 48'		---	EESB-1048-26L-120-277V

**\*EESB-0250-16L-120-277V Ultimate Ballast Replaces all models.**