



EFM1 Medium Output LED Flood Light

The Evolve® LED Medium Output Flood Light is our mid-lumen solution to efficiently illuminate building facade, flag poles, billboard signage and many more traditional flood applications. Designed to replace from 150W - 400W HID flood light solutions.



Construction

Housing:	Aluminum die cast enclosure. Integral heat sink for maximum heat transfer
Lens:	Impact resistant tempered glass
Paint:	Corrosion resistant polyester powder painted, minimum 2.0 mil thickness Standard = Black, Dark Bronze, Gray, White (RAL & custom colors available) Optional = Coastal Finish
Weight:	25 lbs (11.34 kgs)

Optical System

Lumens:	5,000 to 27,000
Distribution:	6x5, 6x6, 7x6, 7x7, Type III, 20° Spot
Efficacy:	104-167 LPW
CCT:	3000K, 4000K, 5000K
CRI (Min):	≥70

Electrical

Input Voltage:	120-277V & 347-480V
Input Frequency:	50/60Hz
Power Factor:	> 90% at rated watts
Total Harmonic Distortion:	< 20% at rated watts

Surge Protection

TYPICAL (120 STRIKES)	ENHANCED (40 STRIKES)	EXTREME (40 STRIKES)
6kV/3kA*	10kV/5kA*	20kV/10kA*

*Per ANSI C136.2-2015

Lumen Maintenance

Projected Lxx per IES TM-21-11 at 25°C

LUMEN CODES	DISTRIBUTION	LXX(10K) @ HOURS		
		25,000 HR	50,000 HR	60,000 HR
AA, BB, CC	T3 & S2	L89	L80	L76
AA, BB, CC, DD	65, 66, 76, & 77	L95	L92	L91
EE, FF	65, 66, 76, & 77	L93	L88	L86

Note: Projected LXX based on LM80 (> 10,000 hour testing). Accepted industry tolerances apply to initial luminous flux and lumen maintenance measurements.

Luminaire Ambient Temperature Factor

AMBIENT TEMP (°C)	INITIAL FLUX FACTOR	AMBIENT TEMP (°C)	INITIAL FLUX FACTOR
10	1.02	30	0.99
20	1.01	40	0.98
25	1.00	50	0.97

Ratings

Operating Temperature:	-40°C to 50°C
Vibration:	3G per ANSI C136.31-2010
LM-79:	Testing in accordance with IESNA Standards

Controls

Dimming:	Standard - 0-10V Optional - DALI (Option U)
Sensors:	Photo Electric Sensors (PE) available LightGrid and Daintree Compatible

Warranty

5 Year (Standard)

Not all product variations listed on this page are DLC qualified. Visit www.designlights.org/search to confirm qualifications.



Ordering Information

EFM1 01

7

PROD. ID	GEN	VOLTAGE	OPTIC CODE	DISTRIBUTION ³	CRI	CCT	DIMMING	CONTROLS	MOUNTING	COLOR	OPTIONS
E = Evolve	01	0 = 120-277V ¹	AA = 5000 lm	65 = NEMA 6x5	7 = 70	30 = 3000K	A = ANS 36.41 7-Pin Receptacle ⁴	A = No Control	K1 = Knuckle Slipfitter: For 1.9 in.- 2.3 in OD Tenon ⁶	BLCK = Black	F = Fusing ³
F = Flood		H = 347-480V ¹	BB = 10,000 lm	66 = NEMA 6x6		40 = 4000K	D = No receptacle, with external dimming 18/2 3 ft cable	D = Shorting Cap ⁵	K2 = Knuckle slipfitter 1.9 in. - 2.3 in OD Tenon Supplied with 14/3 3ft power cable ¹⁵	DKBZ = Dark Bronze	H = Motion Sensor ⁹
M1 = Medium Output		E = 277-480V ¹¹	CC = 15,000 lm	76 = NEMA 7x6		50 = 5000K	N = No PE Receptacle & Non Dimmable	E = ANSI C136.41 7-pin with non-Dimming PE Control ⁵	S1 = Knuckle Slipfitter: For 2.3 in.- 3.0 in OD Tenon ⁶	GRAY = Gray	H2 = Daintree enabled motion sensor ^{8,9}
		1 = 120V	DD = 20,000 lm	77 = NEMA 7x7 (80° Wide Flood)			P = ANSI 7-Pin Receptacle with external dimming 18/2 3 ft cable ⁴		S2 = Knuckle Slipfitter: For 2.3 in.- 3.0 in OD Tenon ¹⁵	WHITE = White	R = Optional Secondary Enhanced SPD
		2 = 208V	EE = 24,000 lm	T3 = T3 Facade/Billboard ²					T1 = Trunnion ¹⁵		T = Optional Secondary Extreme SPD
		3 = 240V	FF = 27,000 lm	S2 = 20° Spot ²					V1 = Knuckle Wall ⁶		U = DALI Programmable ^{7,8}
		4 = 277V									V0 = 3 Position Terminal Block
		D = 347V									V1 = Variable output via Field Adjustable Module
		5 = 480V									Y = Coastal Finish ¹⁰
											XXX = Special Options

¹ Not Available with Fusing

² Not Available with "DD", "EE", or "FF" optical codes

³ Nominal IES Type classing subject to typical variation, individual units may differ.

⁴ Restricted Aiming Angle of 0-45°

⁵ Can only be ordered with "A" or "P" Dimming Options

⁶ Supplied with leads

⁷ Compatible with LightGrid System

⁸ Not available in 347V, 480V or 347-480V

⁹ Only available in mount K1 or S1

¹⁰ Recommended for installations within 750 feet from coast. Lead time varies, check with factory.

¹¹ Only available with optic code CC and DD

¹² PE Control only available for 120-277V, 347V or 480V discrete voltage

¹³ Dimming and Fusing not available with Optical Code AA for distributions "T3" and "S2"

¹⁵ External 3ft #14/3 power cable

CUSTOMER NAME _____

PROJECT NAME _____

DATE _____ TYPE _____

CATALOG NUMBER _____

OPTICAL CODE	DIST CODE	CLASSIFICATION	TYPICAL LUMENS		TYPICAL SYSTEM WATTAGE	
			3000K	4000K/5000K	120-277V	347-480V
AA	77	7x7	4900	5000	30	32
BB			9800	10000	64	64
CC			14700	15000	96	96
DD			20400	20900	146	146
EE			23400	24000	175	175
FF			26200	27000	196	196
AA	76	7x6	4700	4800	30	32
BB			9500	9700	64	64
CC			14300	14600	96	96
DD			19900	20400	146	146
EE			23300	23900	175	175
FF			25600	26300	196	196
AA	66	6x6	4700	4800	30	32
BB			9400	9600	64	64
CC			14200	14500	96	96
DD			19700	20200	146	146
EE			22900	23500	175	175
FF			25200	25900	196	196
AA	65	6x5	4400	4500	30	32
BB			8900	9100	64	64
CC			13400	13700	96	96
DD			18700	19100	146	146
EE			21600	22200	175	175
FF			23800	24400	196	196
AA	T3	Type 3	6400	6600	50	50
BB	T3	Type 3	10200	10500	88	88
CC	T3	Type 3	14700	15000	141	141
AA	S2	20° Spot	7100	7300	50	50
BB	S2	20° Spot	11300	11600	88	88
CC	S2	20° Spot	16300	16700	141	141

For additional information on EFM1 IES files, please click one of the following links:

[Non-Shielded](#)

[Shielded](#)



Not all product variations listed on this page are DLC qualified. Visit www.designlights.org/search to confirm qualifications.

EFM1
NEMA 6x5

19,100 Lumens
4000K
EFM101_DD65740_IES

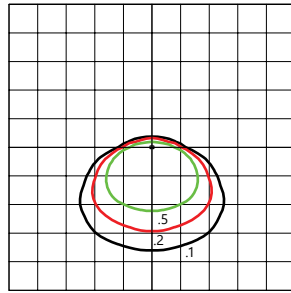

- Mounting Height at 35'
- Tilt is 45° Initial Footcandle at Grade

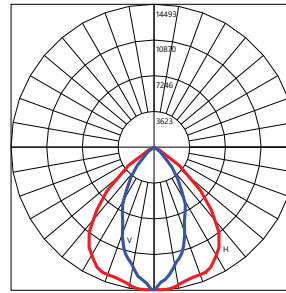

- Vertical angle of Max Cd. at -2.5°
- Horizontal angle of Max Cd. at 2.5°

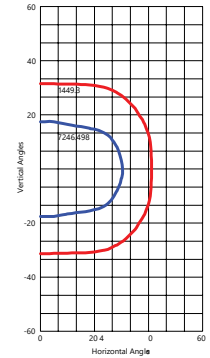

EFM1
NEMA 6x6

20,200 Lumens
4000K
EFM101_DD66740_IES

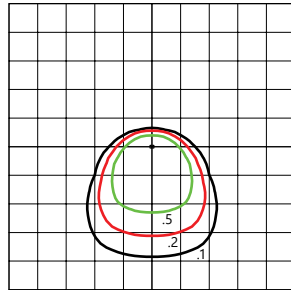

- Mounting Height at 35'
- Tilt is 45° Initial Footcandle at Grade

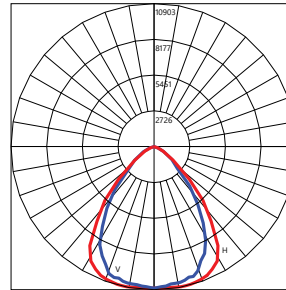

- Vertical angle of Max Cd. at -5°
- Horizontal angle of Max Cd. at 2.5°

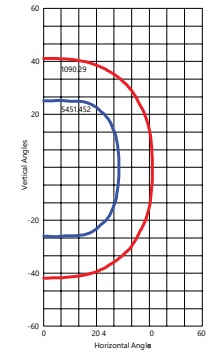

EFM1
NEMA 7x6

20,400 Lumens
4000K
EFM101_DD76740_IES

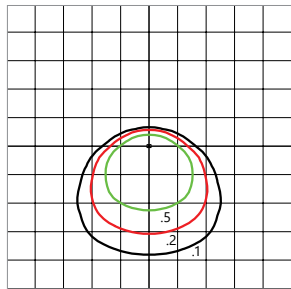

- Mounting Height at 35'
- Tilt is 45° Initial Footcandle at Grade

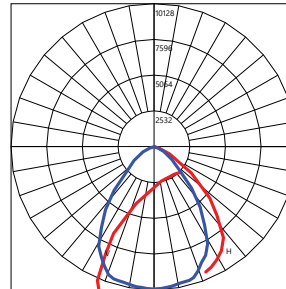

- Vertical angle of Max Cd. at -2.5°
- Horizontal angle of Max Cd. at 2.5°

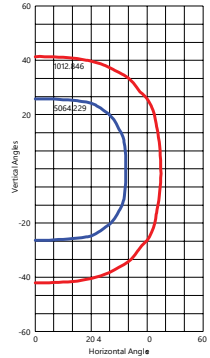

EFM1
NEMA 7x7

20,900 Lumens
4000K
EFM101_DD77740_IES

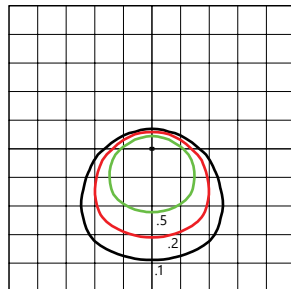

- Mounting Height at 35'
- Tilt is 45° Initial Footcandle at Grade

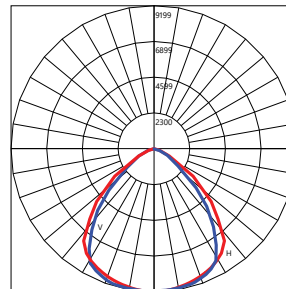

- Vertical angle of Max Cd. at -7.5°
- Horizontal angle of Max Cd. at 5°

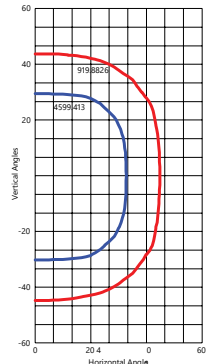

EFM1
TYPE III
FACADE/BILLBOARD

15,000 Lumens
4000K
EFM101_CCT3740_IES

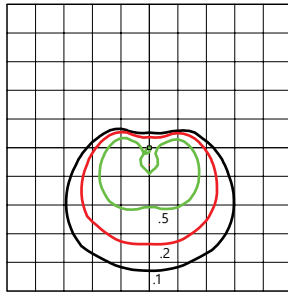

- Mounting Height at 35'
- Tilt is 25° Initial Footcandle at Grade

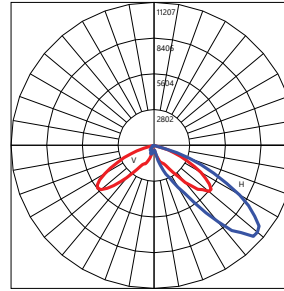

- Vertical angle of Max Cd. at 47.5°
- Horizontal angle of Max Cd. at 15°

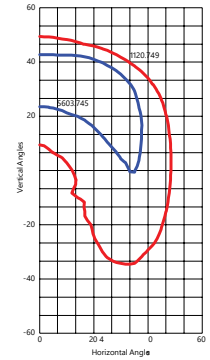

EFM1
20° SPOT

16,700 Lumens
4000K
EFM101_CCS2740_IES

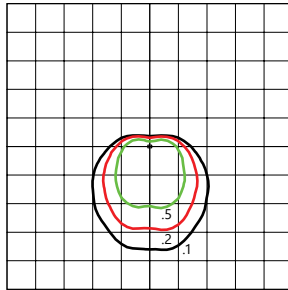

- Mounting Height at 35'
- Tilt is 45° Initial Footcandle at Grade

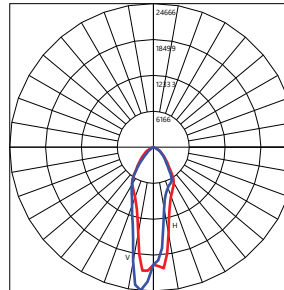

- Vertical angle of Max Cd. at -5°
- Horizontal angle of Max Cd. at 0°

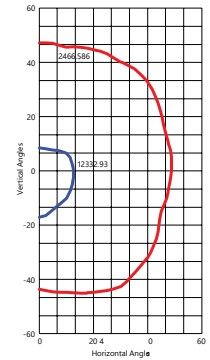

CUSTOMER NAME _____

PROJECT NAME _____

DATE _____ TYPE _____

CATALOG NUMBER _____

H1 Motion Sensing Option

Recommended Mounting Height:	15-30' (4.6-9.1m)
Coverage Radius:	15-20' (4.6-6.1 m)
Lateral Coverage:	300 °
Total Harmonic Distortion:	≤ 20% at rated watts
Default Settings:	
Output:	Occupied - 100%/Unoccupied - 50%
PE Sensor:	Enabled
Ramp/Fade:	5 Minutes/5 Minutes
Adds:	< 1W to fixture power rating

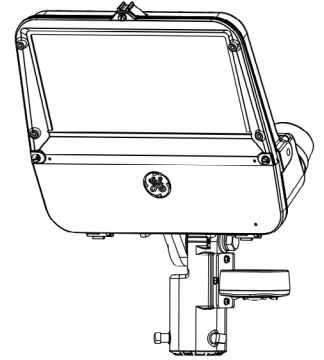
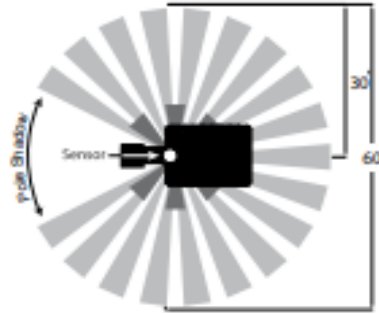

H2 Motion Sensing Option

Recommended Mounting Height:	15-30' (4.6-9.1m)
Coverage Radius:	15-20' (4.6-6.1 m)
Lateral Coverage:	300 °
Total Harmonic Distortion:	≤ 20% at rated watts
Default Settings:	
Output:	Occupied - 100%/Unoccupied - 50%
PE Sensor:	Enabled
Ramp/Fade:	5 Minutes/5 Minutes
Adds:	< 1W to fixture power rating
Requires Daintree Enterprise and wide area control (WAC)	

TRUNNION MOUNT

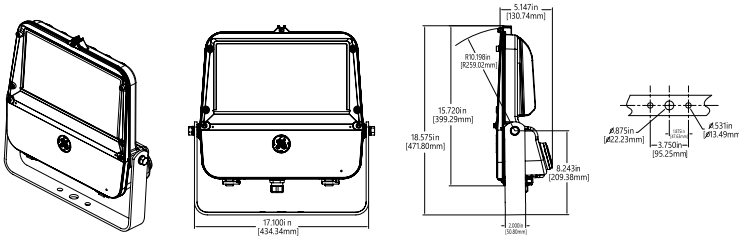

KNUCKLE SLIPFITTER MOUNT

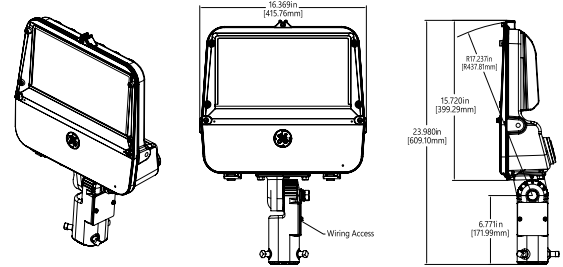

KNUCKLE WALL MOUNT

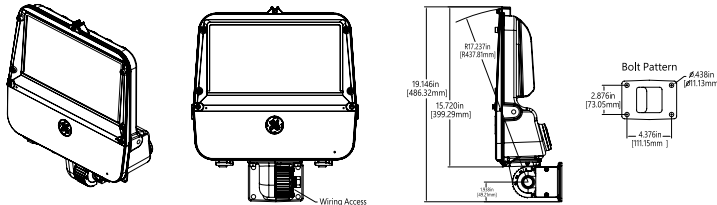

EFM1 - PE AIMING RESTRICTIONS

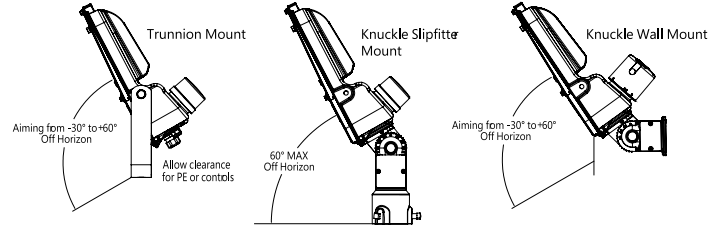

Mounting

- Adjustable for 1.25 to 1 in. nominal mounting pipe
- Integral diecast mounting pipe stop
- Slipfitter with +/- 5 degrees of leveling adjustment

Data

- Approximate Weight: 25 lbs. (11.34 kg)
- Effective Projected Area:
 - 0° aim (vertical glass) 1.96 sq. ft.
 - 45° aim 1.22 sq. ft.
 - Side profile (all aims) 0.73 sq. ft.
 - 90° (downward) aim 0.79 sq. ft.

Effective Projected Area

- — 0° aim (vertical glass) 1.96 sq. ft.
- — 45° aim 1.22 sq. ft.
- — Side profile (all aims) 0.73 sq. ft.
- — 90° (downward) aim 0.79 sq. ft.

Shields

Accessories

SAP NUMBER	PART NUMBER	DESCRIPTION
93123552	WANSI - 277	ANSI 136.41 Dimming PE Danitree Enable, 105-305V
93123553	WANSI - 480	ANSI 136.41 Dimming PE Danitree Enable, 312-530V
93029237	PED-MV-LED-7	ANSI C136.41 Dimming PE, 120-277V
93029238	PED-347-LED-7	ANSI C136.41 Dimming PE, 347V
93029239	PED-480-LED-7	ANSI C136.41 Dimming PE, 480V
28299	PECOTL	Standard 120-277V
28294	PEC5TL	Standard 480V
80436	PECDTL	Standard 347V
73251	SCCL-PECTL	Shorting Cap

SAP NUMBER	PART NUMBER	DESCRIPTION
93081902	TSVBLCk-EFM	Top and Side Visor
93081903	TSVDKBZ-EFM	Top and Side Visor
93081901	TSVGRAY-EFM	Top and Side Visor
93081904	TSVWHITE-EFM	Top and Side Visor
93080086	VAN-EFM	Vandal Shield
93080087	WG-EFM	Wire Guard
93079843	BDABLCk-EFM	Barn Doors
93079844	BDADKBZ-EFM	Barn Doors
93079842	BDAGRAY-EFM	Barn Doors
93079845	BDAWHITE-EFM	Barn Doors