



GE Evolve[®]

LED Roadway Lighting

ERL1-ERLH-ERL2



current
powered by GE



GE Evolve® LED Roadway Lighting ERL1-ERLH-ERL2



The **Evolve®** LED Roadway Luminaire is optimized for customers requiring a LED solution for local, collector and major roadways. GE's unique reflective optics are designed to optimize application efficiency and minimize glare. The modern design incorporates the heat sink directly into the unit for heat transfer to prolong LED life. This reliable unit has a 100,000 hour design life, significantly reducing maintenance needs and expense over the life of the fixture. This efficient solution lowers energy consumption compared to a traditional HID fixture for additional operating cost savings.

Features:

- Optimized roadway photometric distributions
- **Evolve®** light engine consisting of reflective technology designed to optimize application efficiency and minimize glare
- 70 CRI at 2700K, 3000K and 4000K typical.
- -40°C to 50°C UL Ambient Typical.
- ULOR = 0 (zero uplight)
- Designed & Assembled in USA

Applications:

- Local Roadways
- Collector Roadways
- Major Roadway/Streets



Compatible with **LightGrid** Outdoor Wireless Control System



To learn more about **GE Evolve® LED Roadway Lighting**, go to: www.currentbyge.com

GE Evolve®

LED Roadway Lighting

ERL1-ERLH-ERL2



Project name _____

Date _____

Type _____

Typical Specifications: ERL1-ERLH-ERL2

LED & Optical

- **Output Range:** 1900 – 30000 lm
- **Photometric Options:** Type II Narrow, Type II Wide, Type III, Type IV
- **System Efficacy:** 100 - 145 LPW
- **CCT:** 2700K, 3000K, 4000K; LEDs @ 70 CRI

Lumen Maintenance Tables

Projected Lxx per IES TM-21 at 25°C for reference:

ERL1 LUMEN OUTPUT CODES	LXX(10K)@HOURS		
	25,000 HR	50,000 HR	60,000 HR
02,03,04,05,06	L96	L95	L94
07,08,09	L95	L91	L89
10	L89	L80	L76

ERLH LUMEN OUTPUT CODES	LXX(10K)@HOURS		
	25,000 HR	50,000 HR	60,000 HR
10, 11	L97	L96	L96
13, 14	L95	L93	L92
15, 16	L94	L91	L91

ERL2 LUMEN OUTPUT CODES	LXX(10K)@HOURS		
	25,000 HR	50,000 HR	60,000 HR
16, 18, 19, 21, 23	L96	L94	L95
25, 27, 28	L95	L93	L92
30	L94	L91	L90

Note: Projected Lxx based on LM80 (10,000 hour testing). Accepted industry tolerances apply to initial luminous flux and lumen maintenance measurements.

Electrical

- **Input Voltage:** 120-277 volt and 347-480 volt
- **Input Frequency:** 50/60Hz
- **Power Factor (PF)*:** >90%
- **Total Harmonic Distortion (THD)*:** <20%

*Power factor and THD tolerance exceptions: ERL1 "02" Lumen output: PF and THD within tolerances above only at 120 volt. ERL1 "03" Lumen output: @120 volt PF~0.89; @ 480 volt THD~26% ERL1 "04" Lumen output: @480 volt THD~22%

Ratings

- **Surge Protection:** per ANSI C136.2-2015: (Driver Internal):
 - 6kV/3kA "Basic: (120 Strikes)" - Standard on ERL1 (02-06)
 - 10kV/5kA "Enhanced: (40 Strikes)" - Standard on ERL1 (07 - 10), ERLH, ERL2
- **(Additional Separate Secondary SPD)**
 - 10kV/5kA "Enhanced: (40 Strikes)" - Option "R"
 - 20kV/10kA "Elevated" (40 Strikes) - Option "T"
- **Safety:** UL/cUL Listed. UL 1598 listed, suitable for wet locations (UL) (UL)
- **Environmental:** Compliant with the materials restrictions of RoHS
- **EMI:** Title 47 CFR Part 15 Class A
- **Vibration:** 3G per ANSI C136.31-2010
- LM-79 testing in accordance with IESNA Standards
- Std. Optical enclosure rated per ANSI C136.25-2009:
 - ERL1/ERLH/ERL2 = IP65, Optional: IP66

Operating Temperature:

PRODUCT ID	LUMEN OUTPUT	AMBIENT READING
ERL1	02-10	-40°C to 50°C
ERLH	10-11, 13	-40°C to 50°C
ERLH	14-16	-40°C to 45°C
ERL2	16-28	-40°C to 50°C
ERL2	30	-40°C to 45°C

Delayed start may be experienced < -35°C

Construction & Finish

- **Housing:**
 - Die Cast Enclosure
 - Casting-integral heat sink for maximum heat transfer
- **Lensing:** Impact resistant tempered glass, standard
- **Paint:** Corrosion resistant polyester powder painted, minimum 2.0 mil. thickness.
 - Standard Colors: Dark Bronze, Black, & Gray
 - RAL & custom colors available
 - Optional coastal finish available.
- **Weight:** 12.4lbs (5.6kg) – 24lbs (10.9kg)

Warranty

- **System Warranty:** 5 Year Standard, 10 Year Optional

Controls

- **Dimming:**
 - Standard: 0-10V; Optional: DALI (120-277V Only)
- **Sensors:**
 - Photo electric sensors (PE) available.
- LightGrid™ compatible

Mounting

- Slipfitter with +/- 5 degree of adjustment for leveling.
- Integral die cast mounting pipe stop.
- Adjustable for 1.25 in. or 2 in. mounting pipe.

Suggested HID Replacement Lumen Levels

- ~4,000–5,000 lumens to replace 100W HPS Cobra-head
- ~7,000–8,800 lumens to replace 150W HPS Cobra-head
- ~8,500–11,500 lumens to replace 200W HPS Cobra-head
- ~11,500–14,000 lumens to replace 250W HPS Cobra-head
- ~21,000–30,000 lumens to replace 400W HPS Cobra-head

Note: Actual replacement lumens may vary based upon mounting height, pole spacing, design criteria, etc.

PREVIOUS	DESCRIPTION	CURRENT	DESCRIPTION
A1, B1	Extra Narrow/Narrow Asymmetric	A3	Type II Narrow
C1, E1	Asymmetric Short/Medium	B3	Type II Wide
D1, G1	Asymmetric Forward/Extra Wide	C3	Type III
F1	Asymmetric Wide	D3	Type IV
		E3	Type II Enhanced Back Light

**The information above is designed to provide a guideline to select the correct luminaire for a roadway application. The best and most accurate way to ensure the proper design is to do a lighting layout Utilizing AGI.



International Dark Sky Association listed. 2700K or 3000K must be selected to meet IDA certification and approval.



Project name _____
Date _____
Type _____

ERL2

PROD. ID	VOLTAGE	LUMEN OUTPUT	DISTRIBUTION*	CCT	CONTROLS	COLOR	OPTIONS
E = Evolve R = Roadway L = Local 2 = Double Module	0 = 120-277V* 1 = 120 2 = 208 3 = 240 4 = 277 5 = 480 D = 347 H = 347-480*# * Not available with Fusing. Must choose a discrete voltage with F option. # Not available with E controls option.	16 18 19 21 23 25 27 28 30 See Table	A3 = Type II Narrow B3 = Type II Wide C3 = Type III D3 = Type IV E3 = Type II Enhanced Back Light See Table *Nominal IES Type classing subject to typical variation, individual units may differ.	27 = 2700K <> 30 = 3000K <> 40 = 4000K <> Select 2700K or 3000K CCT for IDA approved units.	A = ANSI C136.41 7-pin D = ANSI C136.41 7-pin with Shorting Cap E = ANSI C136.41 7-pin with non-Dimming PE Control.* *PE Control Only available for 120-277V or 480V Discrete. Not available for 347-480V. NOTE: Dimming controls wired for 0-10V standard unless DALI option "U" requested.	GRAY = Gray BLK = Black DKBZ = Dark Bronze	A = 4 Bolt Slipfitter † F = Fusing G = Internal Bubble Level I = IP66 Optical L = Tool-Less Entry M1 = Magnapack*** R = Secondary 10kV/5kA SPD T = Secondary 20kV/10kA SPD U = DALI Programmable ^ V1 = Variable Output via Field Adjustable Module** Y = Coastal Finish* XXX = Special Options † Contact manufacturer for Lead-Time. * Recommended for installations within 750 ft. from the coast. Contact Factory for Lead-Time. + Compatible with LightGrid 2.0 nodes. ^ Not available in 347V, 480V or 347-480V. ** Not available with DALI (U) option. *** 20 fixtures per Magnapack.

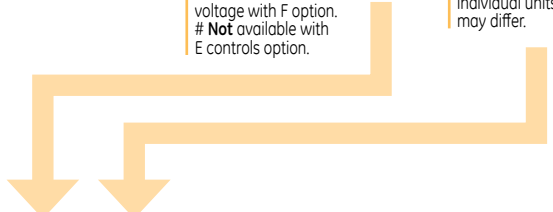

LUMEN OUTPUT	DISTRIBUTION	TYPICAL INITIAL LUMENS			TYPICAL SYSTEM WATTAGE		BUG RATING			IES FILE NUMBER					
		4000K	3000K	2700K	120-277V	347-480V	4000K	3000K	2700K	4000K		3000K		2700K	
										120-277V	347-480V	120-277V	347-480V	120-277V	347-480V
16	A3	16000	15300	14900	120		B3-U0-G3	B3-U0-G3	B3-U0-G3	ERL2_16A340_IES		ERL2_16A330_IES		ERL2_16A327_IES	
	B3						B3-U0-G3	B3-U0-G3	B2-U0-G3	ERL2_16B340_IES		ERL2_16B330_IES		ERL2_16B327_IES	
	C3						B2-U0-G3	B2-U0-G3	B2-U0-G3	ERL2_16C340_IES		ERL2_16C330_IES		ERL2_16C327_IES	
	D3						B2-U0-G3	B2-U0-G3	B2-U0-G3	ERL2_16D340_IES		ERL2_16D330_IES		ERL2_16D327_IES	
	E3						B3-U0-G3	B3-U0-G3	B3-U0-G3	ERL2_16E340_IES		ERL2_16E330_IES		ERL2_16E327_IES	
18	A3	18000	17300	16700	140		B3-U0-G3	B3-U0-G3	B3-U0-G3	ERL2_18A340_IES		ERL2_18A330_IES		ERL2_18A327_IES	
	B3						B3-U0-G3	B3-U0-G3	B3-U0-G3	ERL2_18B340_IES		ERL2_18B330_IES		ERL2_18B327_IES	
	C3						B2-U0-G3	B2-U0-G3	B2-U0-G3	ERL2_18C340_IES		ERL2_18C330_IES		ERL2_18C327_IES	
	D3						B2-U0-G3	B2-U0-G3	B2-U0-G3	ERL2_18D340_IES		ERL2_18D330_IES		ERL2_18D327_IES	
	E3						B3-U0-G3	B3-U0-G3	B3-U0-G3	ERL2_18E340_IES		ERL2_18E330_IES		ERL2_18E327_IES	
19	A3	19000	18200	17700	149		B3-U0-G3	B3-U0-G3	B3-U0-G3	ERL2_19A340_IES		ERL2_19A330_IES		ERL2_19A327_IES	
	B3						B3-U0-G3	B3-U0-G3	B3-U0-G3	ERL2_19B340_IES		ERL2_19B330_IES		ERL2_19B327_IES	
	C3						B3-U0-G3	B2-U0-G3	B2-U0-G3	ERL2_19C340_IES		ERL2_19C330_IES		ERL2_19C327_IES	
	D3						B2-U0-G3	B2-U0-G3	B2-U0-G3	ERL2_19D340_IES		ERL2_19D330_IES		ERL2_19D327_IES	
	E3						B3-U0-G3	B3-U0-G3	B3-U0-G3	ERL2_19E340_IES		ERL2_19E330_IES		ERL2_19E327_IES	
21	A3	21000	20100	19500	174	177	B3-U0-G3	B3-U0-G3	B3-U0-G3	ERL2_21A340_120-277VIES	ERL2_21A340_347-480VIES	ERL2_21A330_120-277VIES	ERL2_21A330_347-480VIES	ERL2_21A327_120-277VIES	ERL2_21A327_347-480VIES
	B3						B3-U0-G3	B3-U0-G3	B3-U0-G3	ERL2_21B340_120-277VIES	ERL2_21B340_347-480VIES	ERL2_21B330_120-277VIES	ERL2_21B330_347-480VIES	ERL2_21B327_120-277VIES	ERL2_21B327_347-480VIES
	C3						B3-U0-G3	B3-U0-G3	B3-U0-G3	ERL2_21C340_120-277VIES	ERL2_21C340_347-480VIES	ERL2_21C330_120-277VIES	ERL2_21C330_347-480VIES	ERL2_21C327_120-277VIES	ERL2_21C327_347-480VIES
	D3						B2-U0-G3	B2-U0-G3	B2-U0-G3	ERL2_21D340_120-277VIES	ERL2_21D340_347-480VIES	ERL2_21D330_120-277VIES	ERL2_21D330_347-480VIES	ERL2_21D327_120-277VIES	ERL2_21D327_347-480VIES
	E3						B3-U0-G3	B3-U0-G3	B3-U0-G3	ERL2_21E340_120-277VIES	ERL2_21E340_347-480VIES	ERL2_21E330_120-277VIES	ERL2_21E330_347-480VIES	ERL2_21E327_120-277VIES	ERL2_21E327_347-480VIES
23	A3	23000	22100	21400	194	196	B3-U0-G3	B3-U0-G3	B3-U0-G3	ERL2_23A340_120-277VIES	ERL2_23A340_347-480VIES	ERL2_23A330_120-277VIES	ERL2_23A330_347-480VIES	ERL2_23A327_120-277VIES	ERL2_23A327_347-480VIES
	B3						B3-U0-G3	B3-U0-G3	B3-U0-G3	ERL2_23B340_120-277VIES	ERL2_23B340_347-480VIES	ERL2_23B330_120-277VIES	ERL2_23B330_347-480VIES	ERL2_23B327_120-277VIES	ERL2_23B327_347-480VIES
	C3						B3-U0-G4	B3-U0-G4	B3-U0-G4	ERL2_23C340_120-277VIES	ERL2_23C340_347-480VIES	ERL2_23C330_120-277VIES	ERL2_23C330_347-480VIES	ERL2_23C327_120-277VIES	ERL2_23C327_347-480VIES
	D3						B2-U0-G4	B2-U0-G4	B2-U0-G4	ERL2_23D340_120-277VIES	ERL2_23D340_347-480VIES	ERL2_23D330_120-277VIES	ERL2_23D330_347-480VIES	ERL2_23D327_120-277VIES	ERL2_23D327_347-480VIES
	E3						B3-U0-G3	B3-U0-G3	B3-U0-G3	ERL2_23E340_120-277VIES	ERL2_23E340_347-480VIES	ERL2_23E330_120-277VIES	ERL2_23E330_347-480VIES	ERL2_23E327_120-277VIES	ERL2_23E327_347-480VIES
25	A3	25000	24000	23300	214		B3-U0-G3	B3-U0-G3	B3-U0-G3	ERL2_25A340_IES		ERL2_25A330_IES		ERL2_25A327_IES	
	B3						B3-U0-G3	B3-U0-G3	B3-U0-G3	ERL2_25B340_IES		ERL2_25B330_IES		ERL2_25B327_IES	
	C3						B3-U0-G4	B3-U0-G4	B3-U0-G4	ERL2_25C340_IES		ERL2_25C330_IES		ERL2_25C327_IES	
	D3						B2-U0-G4	B2-U0-G4	B2-U0-G4	ERL2_25D340_IES		ERL2_25D330_IES		ERL2_25D327_IES	
	E3						B4-U0-G4	B4-U0-G4	B4-U0-G4	ERL2_25E340_IES		ERL2_25E330_IES		ERL2_25E327_IES	
27	A3	27000	25900	25100	237		B3-U0-G3	B3-U0-G3	B3-U0-G3	ERL2_27A340_IES		ERL2_27A330_IES		ERL2_27A327_IES	
	B3						B3-U0-G4	B3-U0-G4	B3-U0-G3	ERL2_27B340_IES		ERL2_27B330_IES		ERL2_27B327_IES	
	C3						B3-U0-G4	B3-U0-G4	B3-U0-G4	ERL2_27C340_IES		ERL2_27C330_IES		ERL2_27C327_IES	
	D3						B2-U0-G4	B2-U0-G4	B2-U0-G4	ERL2_27D340_IES		ERL2_27D330_IES		ERL2_27D327_IES	
	E3						B4-U0-G4	B4-U0-G4	B4-U0-G4	ERL2_27E340_IES		ERL2_27E330_IES		ERL2_27E327_IES	
28	A3	28000	26900	26100	251		B3-U0-G3	B3-U0-G3	B3-U0-G3	ERL2_28A340_IES		ERL2_28A330_IES		ERL2_28A327_IES	
	B3						B3-U0-G4	B3-U0-G4	B3-U0-G4	ERL2_28B340_IES		ERL2_28B330_IES		ERL2_28B327_IES	
	C3						B3-U0-G4	B3-U0-G4	B3-U0-G4	ERL2_28C340_IES		ERL2_28C330_IES		ERL2_28C327_IES	
	D3						B2-U0-G4	B2-U0-G4	B2-U0-G4	ERL2_28D340_IES		ERL2_28D330_IES		ERL2_28D327_IES	
	E3						B4-U0-G4	B4-U0-G4	B4-U0-G4	ERL2_28E340_IES		ERL2_28E330_IES		ERL2_28E327_IES	
30	A3	30000	28800	27900	278		B4-U0-G4	B4-U0-G4	B3-U0-G3	ERL2_30A340_IES		ERL2_30A330_IES		ERL2_30A327_IES	
	B3						B3-U0-G4	B3-U0-G4	B3-U0-G4	ERL2_30B340_IES		ERL2_30B330_IES		ERL2_30B327_IES	
	C3						B3-U0-G4	B3-U0-G4	B3-U0-G4	ERL2_30C340_IES		ERL2_30C330_IES		ERL2_30C327_IES	
	D3						B2-U0-G4	B2-U0-G4	B2-U0-G4	ERL2_30D340_IES		ERL2_30D330_IES		ERL2_30D327_IES	
	E3						B4-U0-G4	B4-U0-G4	B4-U0-G4	ERL2_30E340_IES		ERL2_30E330_IES		ERL2_30E327_IES	

Photometrics: Evolve® LED Streetlight (ERL2)

ERL2

Type II Narrow
(23A340)

23,000 Lumens
4000K
ERL2_23A340___.IES

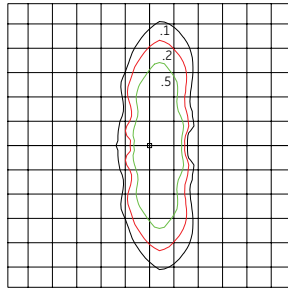

Grid Distance in Units of Mounting Height at 30'
Initial Footcandle Values at Grade

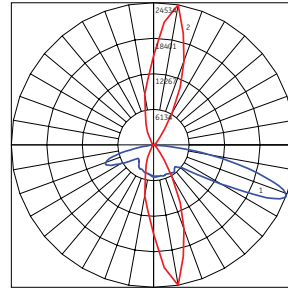

— Vertical plane through horizontal angle of Max. Cd at 80°
— Horizontal cone through vertical angle of Max. Cd at 69°

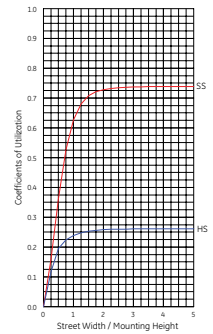

ERL2

Type II Wide
(23B340)

23,000 Lumens
4000K
ERL2_23B340___.IES

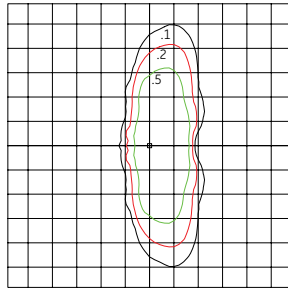

Grid Distance in Units of Mounting Height at 30'
Initial Footcandle Values at Grade

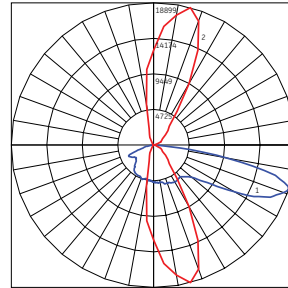

— Vertical plane through horizontal angle of Max. Cd at 75°
— Horizontal cone through vertical angle of Max. Cd at 72°

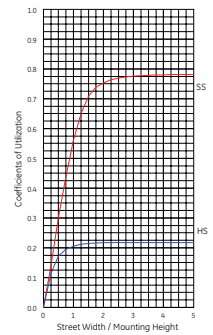

ERL2

Type III
(23C340)

23,000 Lumens
4000K
ERL2_23C340___.IES

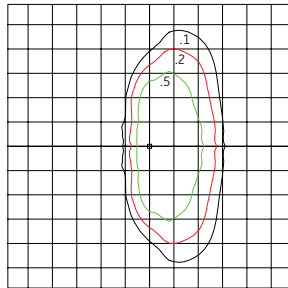

Grid Distance in Units of Mounting Height at 30'
Initial Footcandle Values at Grade

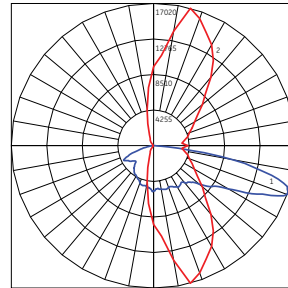

— Vertical plane through horizontal angle of Max. Cd at 75°
— Horizontal cone through vertical angle of Max. Cd at 71°

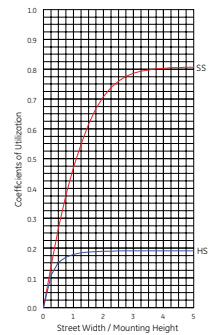

ERL2

Type IV
(23D340)

23,000 Lumens
4000K
ERL2_23D340___.IES

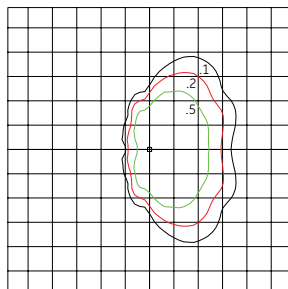

Grid Distance in Units of Mounting Height at 30'
Initial Footcandle Values at Grade

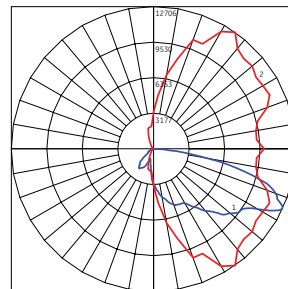

— Vertical plane through horizontal angle of Max. Cd at 55°
— Horizontal cone through vertical angle of Max. Cd at 65°

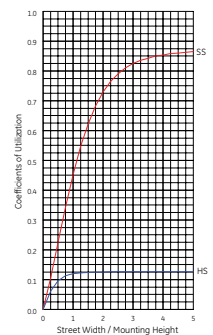

ERL2

Type II Enhanced Back Light
(23E340)

23,000 Lumens
4000K
ERL2_23E340___.IES

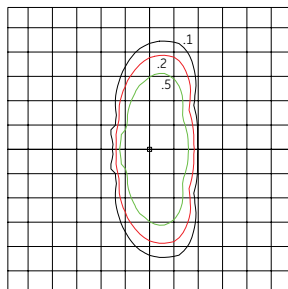

Grid Distance in Units of Mounting Height at 30'
Initial Footcandle Values at Grade

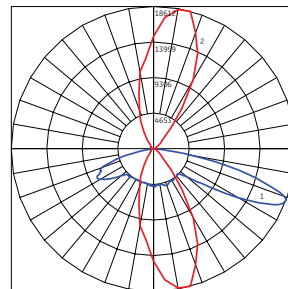

— Vertical plane through horizontal angle of Max. Cd at 75°
— Horizontal cone through vertical angle of Max. Cd at 69°

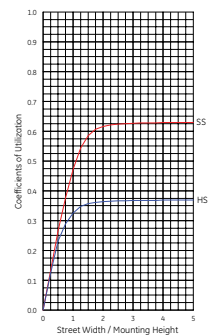

GE Evolve®
 LED Roadway Lighting
 ERL1-ERLH-ERL2

Product Dimensions:
 Evolve® LED Streetlight (ERL2)

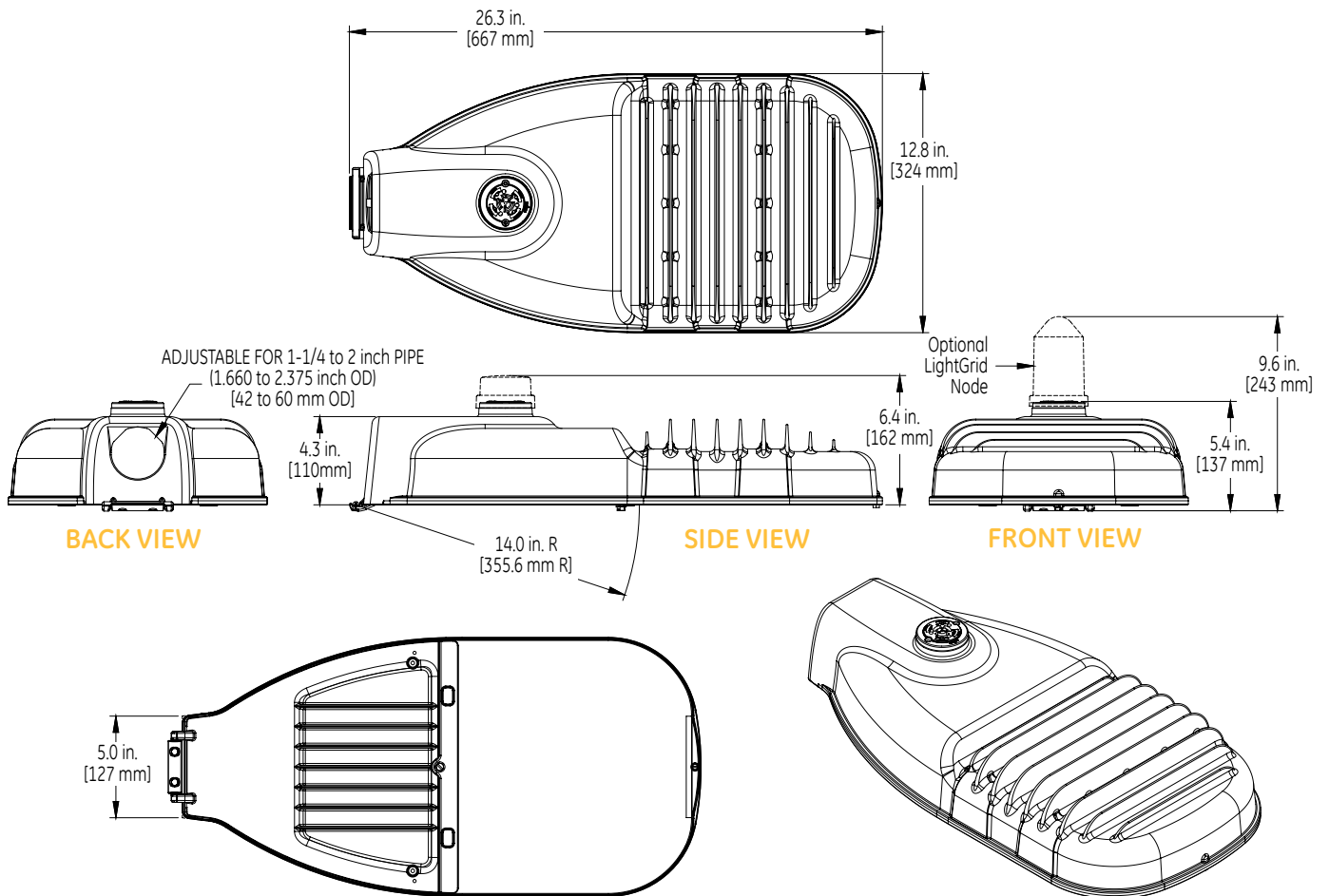

DATA	
	<ul style="list-style-type: none"> • Approximate net weight: 24.0 lbs (10.9 kgs) Contact manufacturer for specific configuration weight. • Effective Projected Area (EPA): 0.57 sq ft max (0.053 sq m)