

Features

- Innovative Design with No Electrolytic Capacitors
- Ultra Long Lifetime: Greater than 100,000 hrs at 85°C Case Temperature
- Full Power at Wide Output Current Range (Constant Power)
- Thermal Sensing and Protection for LED Module
- 0-10V/PWM/Timer Dimmable (3 Timer Modes)
- Dim-to-Off with Standby Power ≤ 0.5 W
- Always-on Auxiliary Power: 12Vdc, 200mA
- Output Lumen Compensation
- Input Surge Protection: 6kV line-line, 10kV line-earth
- All-Around Protection: OVP, SCP, OTP
- Waterproof (IP67) and UL Dry / Damp / Wet Location
- Class 2 & SELV Output
- TYPE HL, for use in a Class I, Division 2 hazardous (Classified) location
- 10 Years Warranty



Description

The EUD-096SxxxDTL series is a novel 96W design that has removed the use of Electrolytic capacitors to extend lifetime at elevated temperatures. It is a constant-current, programmable LED driver that operates from 90-305 Vac input with excellent power factor. Created for many lighting applications including high bay, tunnel and street, it provides a dim-to-off mode with low standby power. The high efficiency of these drivers and compact metal case enables them to run cooler, significantly improving reliability and extending product life. To ensure trouble-free operation, protection is provided against input surge, output over voltage, short circuit, and over temperature of both the driver and the external LED array.

Models

Adjustable Output Current Range	Full-Power Current Range(1)	Default Output Current	Input Voltage Range(2)	Output Voltage Range	Max. Output Power	Typical Efficiency (3)	Power Factor		Model Number
							120Vac	220Vac	
45-700mA	450-700mA	530 mA	90~305Vac 127~300Vdc	74~213Vdc	96 W	92.5%	0.98	0.96	EUD-096S070DTL
70-1050mA	700-1050mA	700 mA	90~305Vac 127~300Vdc	48~137Vdc	96 W	92.0%	0.98	0.96	EUD-096S105DTL
140-2100mA	1400-2100mA	2100 mA	90~305Vac 127~300Vdc	24 ~ 69Vdc	96 W	91.5%	0.98	0.96	EUD-096S210DTL ⁽⁴⁾
175-2150mA	1750-2150mA	2100 mA	90~305Vac 127~300Vdc	24 ~ 55Vdc	96 W	91.0%	0.98	0.96	EUD-096S215DTL ⁽⁵⁾
245-3500mA	2450-3500mA	2800 mA	90~305Vac 127~300Vdc	14 ~ 39Vdc	96 W	91.5%	0.98	0.96	EUD-096S350DTL ⁽⁵⁾

- Notes:** (1) Output current range with constant power at 96W
 (2) UL, FCC certified input voltage range: 100-277Vac or 127-300Vdc; otherwise: 100-240Vac or 127-250Vdc (except KS)
 (3) Measured at 100% load and 220Vac input (see below "General Specifications" for details).
 (4) SELV Output.
 (5) Class 2 & SELV Output.

I-V Operating Area

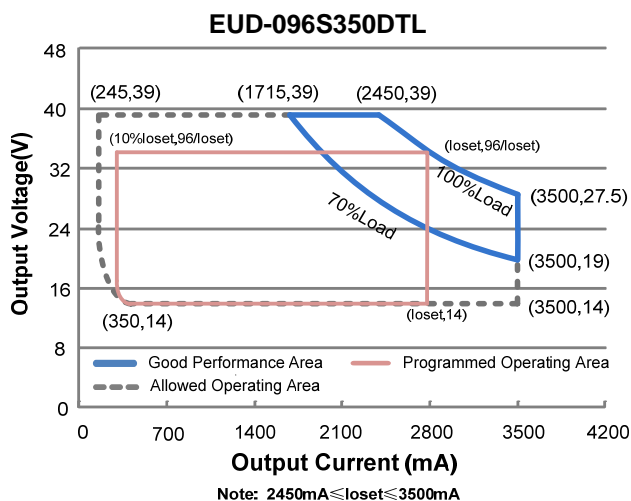
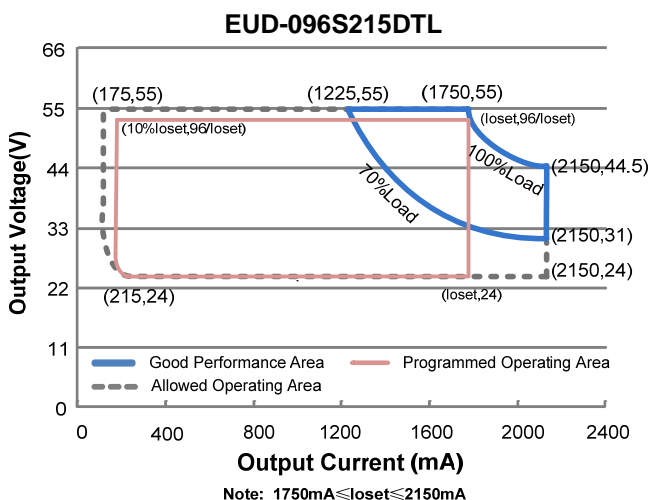
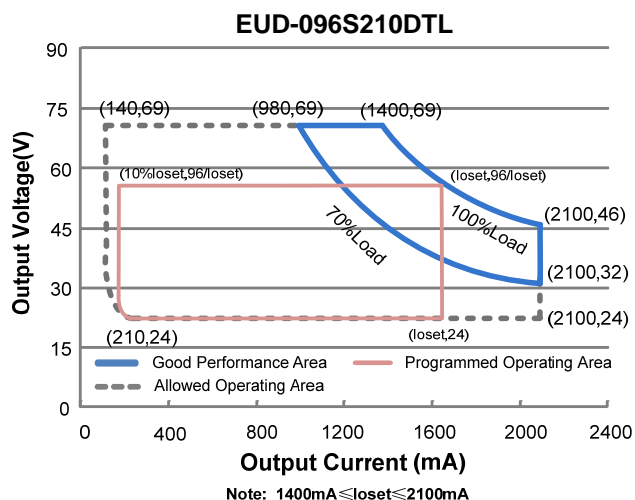
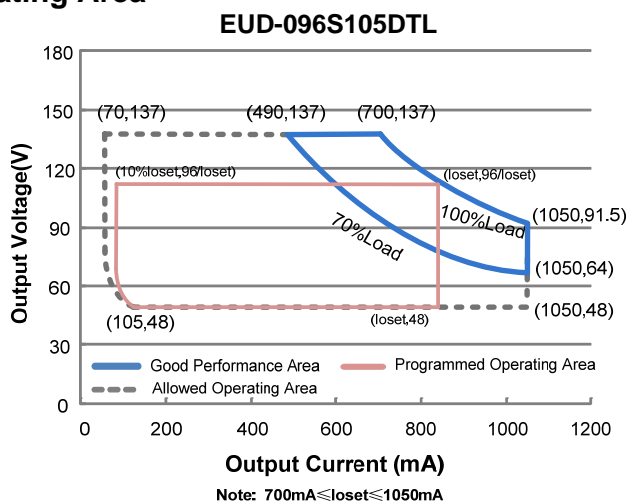
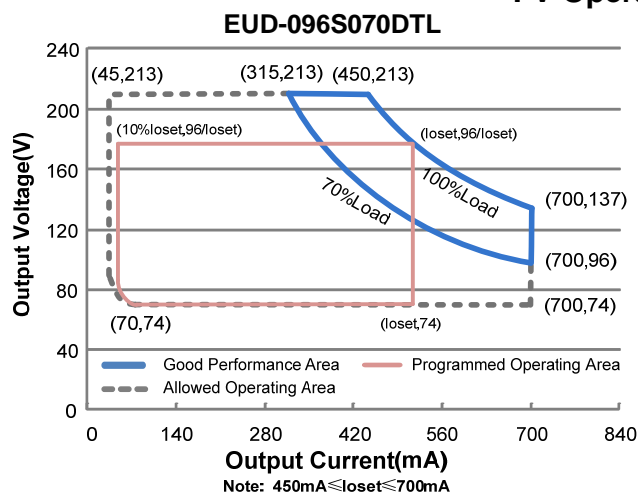

Input Specifications

Parameter	Min.	Typ.	Max.	Notes
Input Voltage	90 Vac	-	305 Vac	127~300 Vdc
Input Frequency	47 Hz	-	63 Hz	
Leakage Current	-	-	0.75 MIU	UL8750; 277Vac/ 60Hz
	-	-	0.70 mA	IEC60598-1; 240Vac/ 60Hz
Input AC Current	-	-	1.20 A	Measured at 100% load and 100 Vac input.
	-	-	0.50 A	Measured at 100% load and 220 Vac input.
Inrush Current(I ² t)	-	-	0.76 A ² s	At 220Vac input, 25°C Cold Start, Duration=116 μs, 10%Ipk-10%Ipk. See Inrush Current Waveform for the details.
PF	0.90	-	-	At 100-277Vac, 50-60Hz, 70%-100% Load (67-96W)
THD	-	-	20%	
THD	-	-	10%	At 220-240Vac, 50-60Hz, 75%-100% Load (72-96W)

Output Specifications

Parameter	Min.	Typ.	Max.	Notes
Output Current Tolerance	-5%loset	-	5%loset	100% load
Output Current Setting(loset) Range				
EUD-096S070DTL	45 mA	-	700 mA	
EUD-096S105DTL	70 mA	-	1050 mA	
EUD-096S210DTL	140 mA	-	2100 mA	
EUD-096S215DTL	175 mA	-	2150 mA	
EUD-096S350DTL	245 mA	-	3500 mA	
Output Current Setting Range with Constant Power				
EUD-096S070DTL	450 mA	-	700 mA	
EUD-096S105DTL	700 mA	-	1050 mA	
EUD-096S210DTL	1400 mA	-	2100 mA	
EUD-096S215DTL	1750 mA	-	2150 mA	
EUD-096S350DTL	2450 mA	-	3500 mA	
Total Output Current Ripple (pk-pk)	-	8%Iomax	15%Iomax	100% load, 20 MHz BW
Output Current Ripple at < 200 Hz (pk-pk)	-	2%Iomax	-	100% load. Only this component of ripple is associated with visible flicker.
Startup Overshoot Current	-	-	10%Iomax	100% load
No Load Output Voltage				
EUD-096S070DTL	-	-	230 V	
EUD-096S105DTL	-	-	160 V	
EUD-096S210DTL	-	-	77 V	
EUD-096S215DTL	-	-	59 V	
EUD-096S350DTL	-	-	45 V	
Line Regulation	-	-	±0.5%	100% load
Load Regulation	-	-	±1.5%	

Output Specifications (Continued)

Parameter	Min.	Typ.	Max.	Notes
Turn-on Delay Time	-	-	1.0 s	Measured at 120Vac input, 70%-100% Load
	-	-	0.5 s	Measured at 220Vac input, 70%-100% Load
Temperature Coefficient of I _o set	-	0.03%/°C	-	Case temperature = 0°C ~T _c max
12V Auxiliary Output Voltage	10.8 V	12 V	13.2 V	
12V Auxiliary Output Source Current	0 mA	-	200 mA	Return terminal is "Dim-"

Note: All specifications are typical at 25°C unless otherwise stated.

General Specifications

Parameter	Min.	Typ.	Max.	Notes
Efficiency at 120 Vac input:				Measured at 100% load and steady-state temperature in 25°C ambient; (Efficiency will be about 2.0% lower if measured immediately after startup.)
EUD-096S070DTL				
I _o = 450 mA	88.5%	90.5%	-	
I _o = 700 mA	87.5%	89.5%	-	
EUD-096S105DTL				
I _o = 700 mA	88.0%	90.0%	-	
I _o = 1050 mA	87.0%	89.0%	-	
EUD-096S210DTL				
I _o = 1400 mA	87.5%	89.5%	-	
I _o = 2100 mA	86.0%	88.0%	-	
EUD-096S215DTL				
I _o = 1750 mA	87.0%	89.0%	-	
I _o = 2150 mA	86.0%	88.0%	-	
EUD-096S350DTL				
I _o = 2450 mA	87.5%	89.5%	-	
I _o = 3500 mA	86.5%	88.5%	-	
Efficiency at 220 Vac input:				Measured at 100% load and steady-state temperature in 25°C ambient; (Efficiency will be about 2.0% lower if measured immediately after startup.)
EUD-096S070DTL				
I _o = 450 mA	90.5%	92.5%	-	
I _o = 700 mA	89.5%	91.5%	-	
EUD-096S105DTL				
I _o = 700 mA	90.0%	92.0%	-	
I _o = 1050 mA	89.0%	91.0%	-	
EUD-096S210DTL				
I _o = 1400 mA	89.5%	91.5%	-	
I _o = 2100 mA	88.5%	90.5%	-	
EUD-096S215DTL				
I _o = 1750 mA	89.0%	91.0%	-	
I _o = 2150 mA	88.0%	90.0%	-	
EUD-096S350DTL				
I _o = 2450 mA	89.5%	91.5%	-	
I _o = 3500 mA	88.0%	90.0%	-	

General Specifications (Continued)

Parameter	Min.	Typ.	Max.	Notes
Efficiency at 277 Vac input: EUD-096S070DTL I _o = 450 mA I _o = 700 mA EUD-096S105DTL I _o = 700 mA I _o = 1050 mA EUD-096S210DTL I _o = 1400 mA I _o = 2100 mA EUD-096S215DTL I _o = 1750 mA I _o = 2150 mA EUD-096S350DTL I _o = 2450 mA I _o = 3500 mA	91.0% 90.0% 90.5% 89.5% 90.0% 88.5% 89.0% 88.0% 90.0% 88.5%	93.0% 92.0% 92.5% 91.5% 92.0% 90.5% 91.0% 90.0% 92.0% 90.5%	- - - - - - - - - -	Measured at 100% load and steady-state temperature in 25°C ambient; (Efficiency will be about 2.0% lower if measured immediately after startup.)
Standby power	-	-	0.5 W	Measured at 230Vac/50Hz; Dimming off
MTBF	-	219,000 Hours	-	Measured at 220Vac input, 80%Load and 25°C ambient temperature (MIL-HDBK-217F)
Lifetime	-	100,000 Hours	-	Measured at 220Vac input, 80%Load and 85°C case temperature; See lifetime vs. T _c curve for the details
Operating Case Temperature for Safety T _{c_s}	-40°C	-	+89°C	
Operating Case Temperature for Warranty T _{c_w}	-40°C	-	+75°C	Case temperature for 10 years warranty. Please see <i>Inventronics EUD-DTL Warranty Statement</i> for complete details.
Storage Temperature	-40°C	-	+85°C	Humidity: 5%RH to 100%RH
Dimensions Inches (L × W × H) Millimeters (L × W × H)		7.09 × 2.66 × 1.44 180 × 67.5 × 36.5		With mounting ear 7.92 × 2.66 × 1.44 201 × 67.5 × 36.5
Net Weight	-	960 g	-	

Note: All specifications are typical at 25°C unless otherwise stated.

Dimming Specifications

Parameter	Min.	Typ.	Max.	Notes	
Absolute Maximum Voltage on the V _{dim} (+) Pin	-20 V	-	20 V		
Source Current on V _{dim} (+) Pin	200 uA	300 uA	450 uA	V _{dim} (+) = 0 V	
Dimming Output Range	EUD-096S070DTL EUD-096S105DTL EUD-096S210DTL EUD-096S215DTL EUD-096S350DTL	10%I _o set	-	I _o set	450 mA ≤ I _o set ≤ 700 mA 700 mA ≤ I _o set ≤ 1050 mA 1400 mA ≤ I _o set ≤ 2100 mA 1750 mA ≤ I _o set ≤ 2150 mA 2450 mA ≤ I _o set ≤ 3500 mA
	EUD-096S070DTL EUD-096S105DTL EUD-096S210DTL EUD-096S215DTL EUD-096S350DTL	45 mA 70 mA 140 mA 175 mA 245 mA	-	I _o set	45 mA ≤ I _o set < 450 mA 70 mA ≤ I _o set < 700 mA 140 mA ≤ I _o set < 1400 mA 175 mA ≤ I _o set < 1750 mA 245 mA ≤ I _o set < 2450 mA

Dimming Specifications (Continued)

Parameter	Min.	Typ.	Max.	Notes
Recommended Dimming Input Range	0 V	-	10 V	Default 0-10V dimming mode.
Dim off Voltage	0.35 V	0.5 V	0.65 V	
Dim on Voltage	0.55 V	0.7 V	0.85 V	
Hysteresis	-	0.2 V	-	
PWM_in High Level	3 V	-	10 V	Dimming mode set to PWM in PC interface.
PWM_in Low Level	-0.3 V	-	0.6 V	
PWM_in Frequency Range	200 Hz	-	3 KHz	
PWM_in Duty Cycle	1%	-	99%	
PWM Dimming off (Positive Logic)	2%	5%	8%	
PWM Dimming on (Positive Logic)	4%	7%	10%	
PWM Dimming off (Negative Logic)	92%	95%	98%	
PWM Dimming on (Negative Logic)	90%	93%	96%	
Hysteresis	-	2%	-	

Note: All specifications are typical at 25°C unless otherwise stated.

Safety & EMC Compliance

Safety Category	Standard
UL/CUL	UL 8750, UL 1310, CAN/CSA-C22.2 No. 250.13, CAN/CSA-C22.2 No. 223-M91
CE	EN 61347-1, EN61347-2-13
KS	KS C 7655
EMI Standards	Notes
EN 55015 ⁽¹⁾	Conducted emission Test & Radiated emission Test
EN 61000-3-2	Harmonic current emissions
EN 61000-3-3	Voltage fluctuations & flicker
FCC Part 15 ⁽¹⁾	ANSI C63.4 Class B
	This device complies with Part 15 of the FCC Rules. Operation is subject to the following two conditions: [1] this device may not cause harmful interference, and [2] this device must accept any interference received, including interference that may cause undesired Operation.
EMS Standards	Notes
EN 61000-4-2	Electrostatic Discharge(ESD): 8kV air discharge, 4kV contact discharge
EN 61000-4-3	Radio-Frequency Electromagnetic Field Susceptibility Test-RS

Safety & EMC Compliance (Continued)

EMS Standards	Notes
EN 61000-4-4	Electrical Fast Transient/Burst-EFT
EN 61000-4-5	Surge Immunity Test: AC Power Line: line to line 6kV, line to earth 10kV ⁽²⁾
EN 61000-4-6	Conducted Radio Frequency Disturbances test-CS
EN 61000-4-8	Power Frequency Magnetic Field Test
EN 61000-4-11	Voltage Dips
EN 61547	Electromagnetic Immunity Requirements Applies To Lighting Equipment

Note: (1) This LED driver meets the EMI specifications above, but EMI performance of a luminaire that contains it depends also on the other devices connected to the driver and on the fixture itself.

(2) To perform electric strength (hi-pot) testing, the “GDT ground disconnect” (nut and metal lock sheet) on the driver end-cap should be removed temporarily to prevent the internal gas discharge tube from conducting (as allowed by IEC 60598-1 Clause 10.2). After testing is completed, these items must be reinstalled to restore line-to-earth surge protection and secure the end cap.

Lifetime vs. Case Temperature

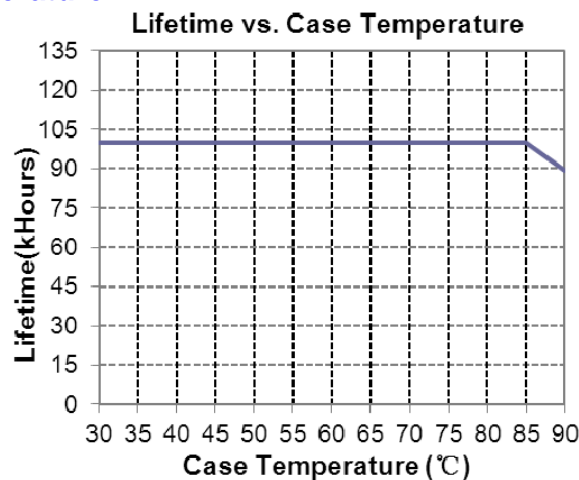

Inrush Current Waveform

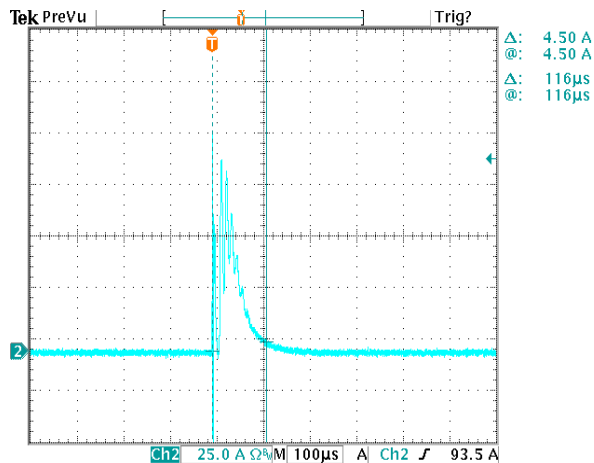

Efficiency vs. Load

EUD-096S070DTL (I_o=450mA)
Efficiency vs. Output Voltage

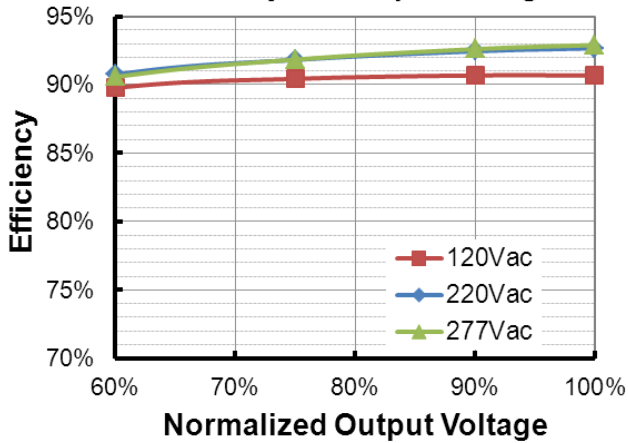

EUD-096S070DTL (I_o=700mA)
Efficiency vs. Output Voltage

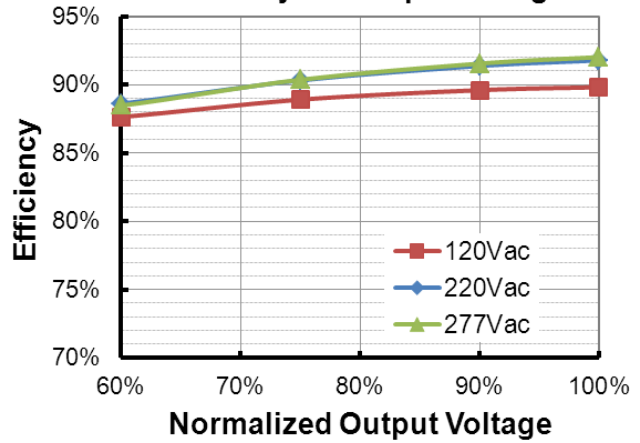

EUD-096S105DTL (I_o=700mA)
Efficiency vs. Output Voltage

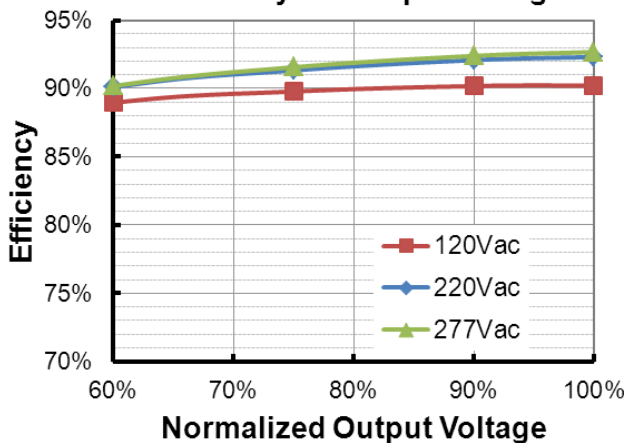

EUD-096S105DTL (I_o=1050mA)
Efficiency vs. Output Voltage

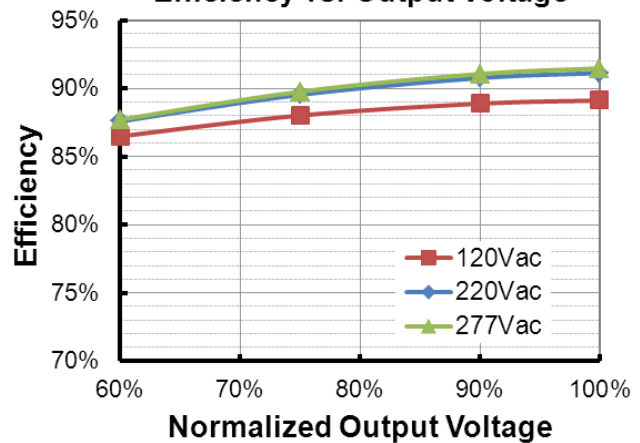

EUD-096S210DTL (I_o=1400mA)
Efficiency vs. Output Voltage

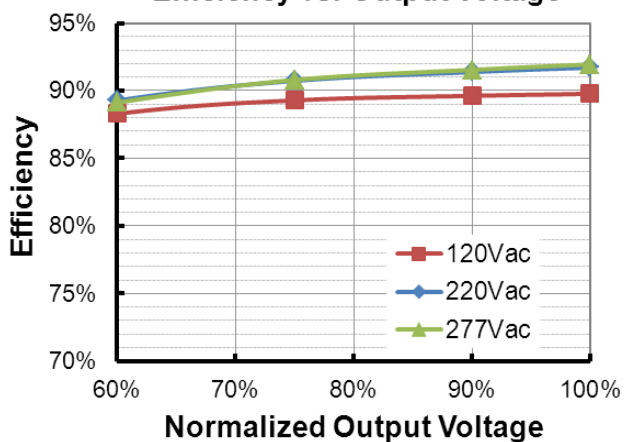

EUD-096S210DTL (I_o=2100mA)
Efficiency vs. Output Voltage

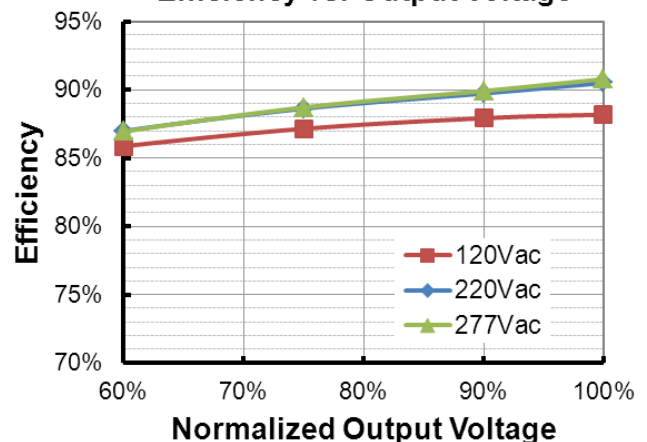

EUD-096S215DTL (Io=1750mA)
Efficiency vs. Output Voltage

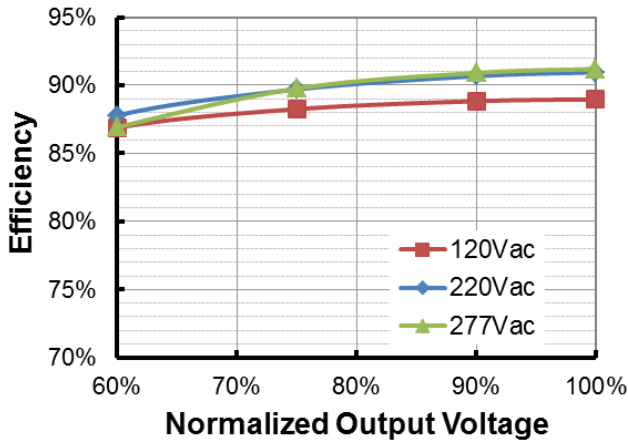

EUD-096S215DTL (Io=2150mA)
Efficiency vs. Output Voltage

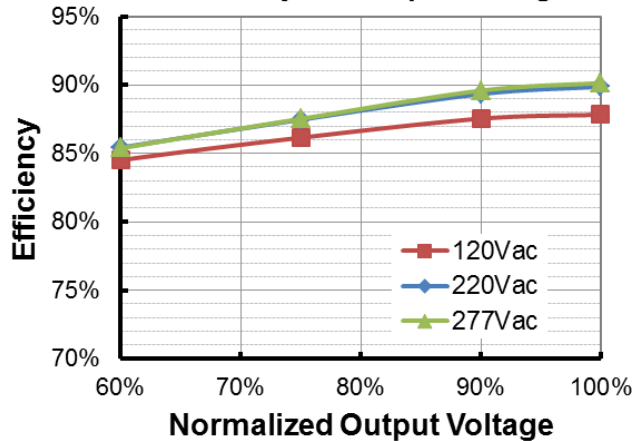

EUD-096S350DTL (Io=2450mA)
Efficiency vs. Output Voltage

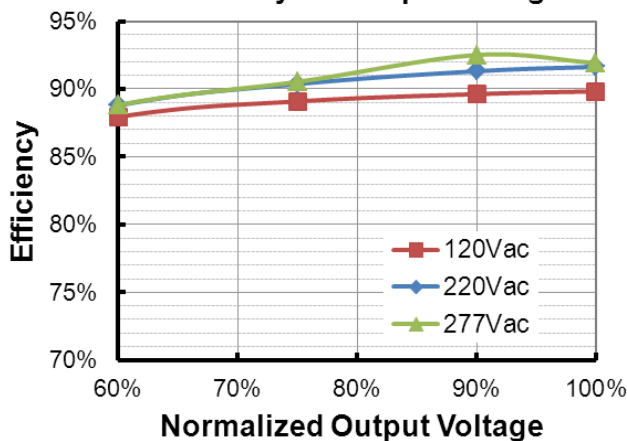

EUD-096S350DTL (Io=3500mA)
Efficiency vs. Output Voltage

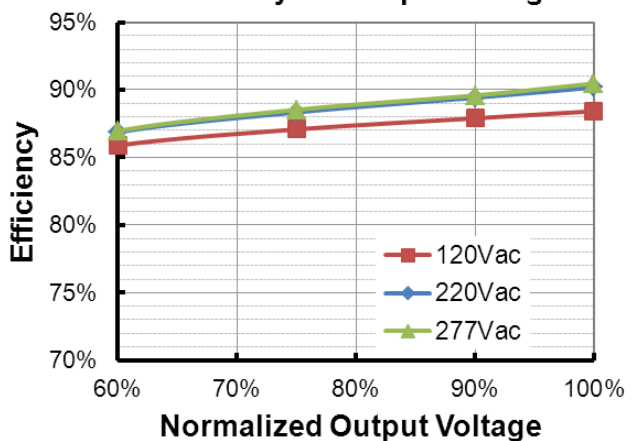

Power Factor

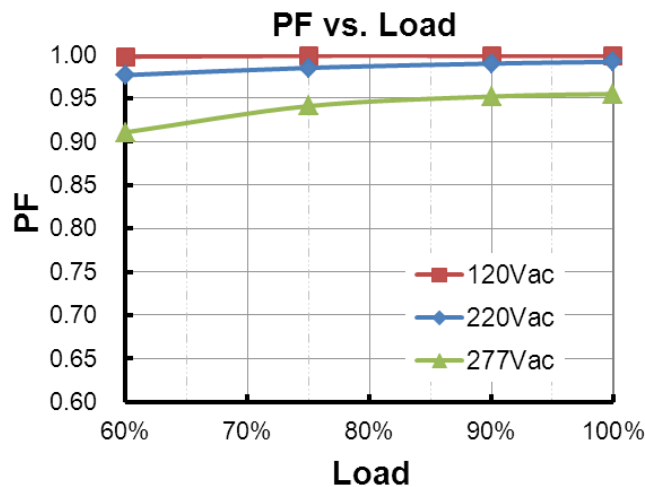

Total Harmonic Distortion

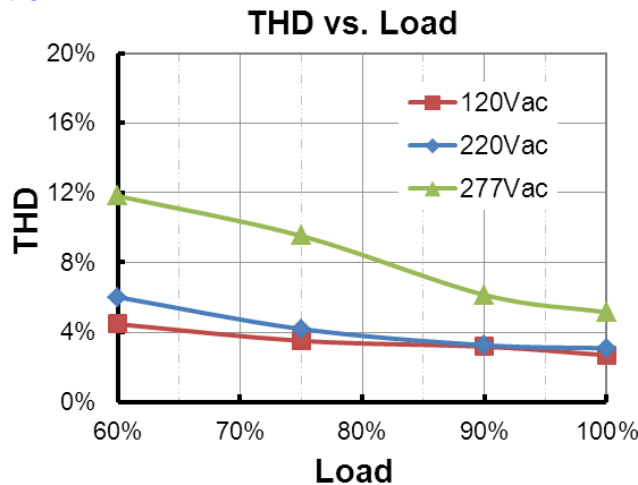

Protection Functions

Parameter		Min.	Typ.	Max.	Notes
External Thermal Protection NTC	R1	-	7.81 kOhm	-	When R_NTC falls below R1, External Thermal Protection is triggered, reducing output current until R2 is reached.
	R2	-	4.16 kOhm	-	When R_NTC is less than R2, output current is reduced to the programmed "Protection Current Floor."
	Protection Current Floor	10%loset lomin	60%loset 60%loset	100%loset 100%loset	10%loset > lomin (default setting is 60%) 10%loset ≤ lomin (default setting is 60%)
Over Temperature Protection		Decreases output current, returning to normal after over temperature is removed.			
Short Circuit Protection		Auto Recovery. No damage will occur when any output is short circuited. The output shall return to normal when the fault condition is removed.			
Over Voltage Protection		Limits output voltage at no load and in case the normal voltage limit fails.			

Dimming

● 0-10V Dimming

The recommended implementation of the dimming control is provided below.

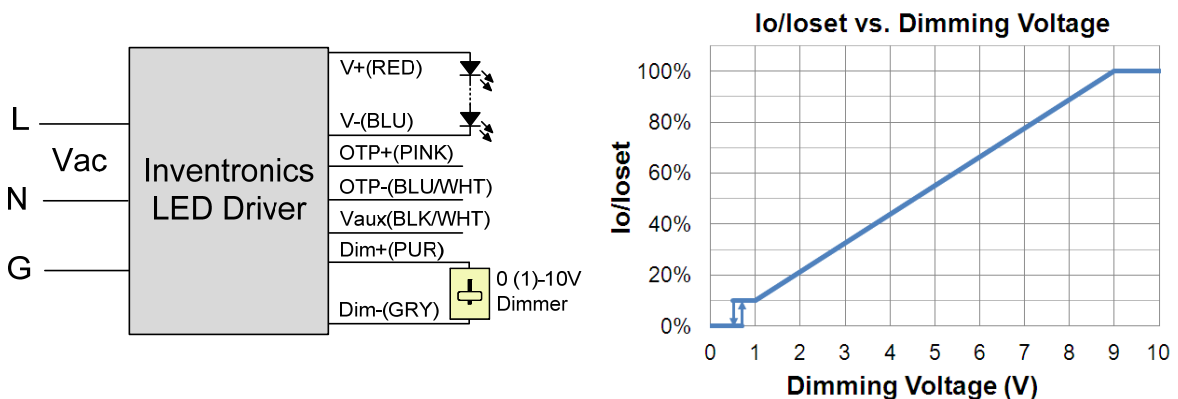

Implementation 1: DC Input

Notes:

1. The dimmer can also be replaced by an active 0-10V voltage source signal or passive components like resistors and zener.
2. Do NOT connect Dim- to the output V- or V+, otherwise the driver will not work properly.
3. If 0-10V dimming is not used, Dim + should be open.

● **PWM Dimming**

The recommended implementation of the dimming control is provided below.

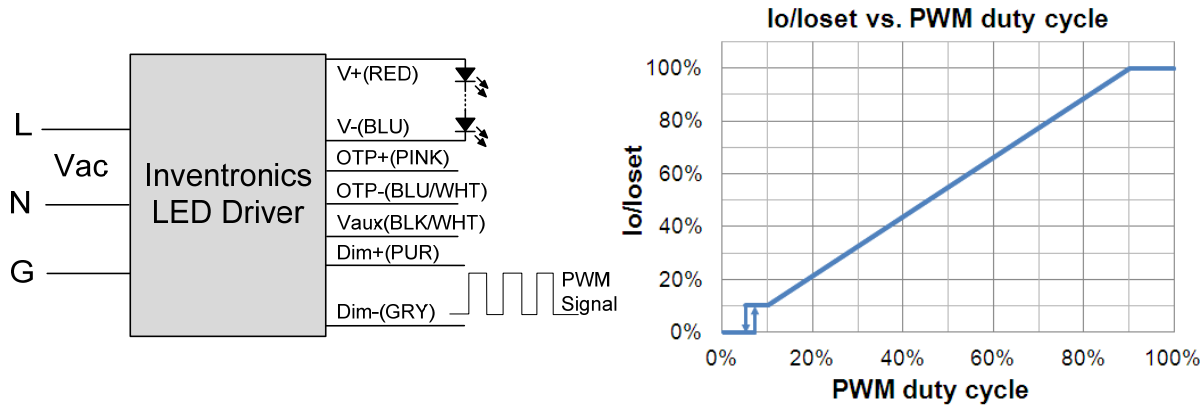

Implementation 2: Positive logic

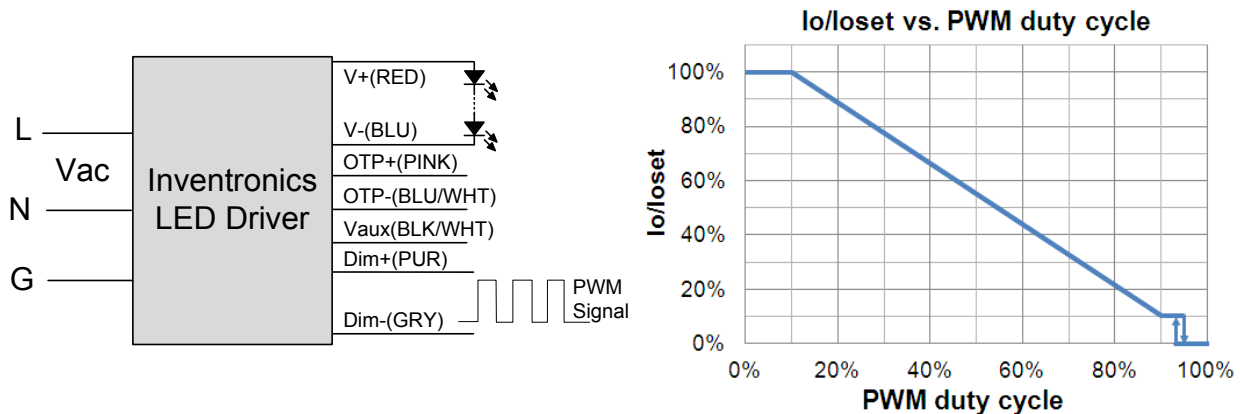

Implementation 3: Negative logic

Notes:

1. Do NOT connect Dim- to the output V- or V+, otherwise the driver will not work properly.
2. If PWM dimming is not used, Dim + should be open.
3. When PWM negative logic dimming mode and Dim+ is open, the driver will output minimum current.

● **Time Dimming**

Time dimming control includes 3 kinds of modes, they are Self Adapting-Midnight, Self Adapting-Percentage and Traditional Timer.

- **Self Adapting-Midnight:** Automatically adjusts the dimming curve based on the on-time of past two days (if difference <15 minutes), assuming that the center point of the dimming curve is midnight local time.
- **Self Adapting-Percentage:** Automatically adjusts the on-time of each step by a constant percentage = (actual on-time for the past 2 days if difference <15 min) / (programmed on-time from the dimming curve).
- **Traditional Timer:** Follows the programmed timing curve after power on with no changes.

● **Output Lumen Compensation**

Output Lumen Compensation (OLC) may be used to maintain constant light output over the life of the LEDs by driving them at a reduced current when new, then gradually increasing the drive current over time to counteract LED lumen degradation.

Programming Connection Diagram

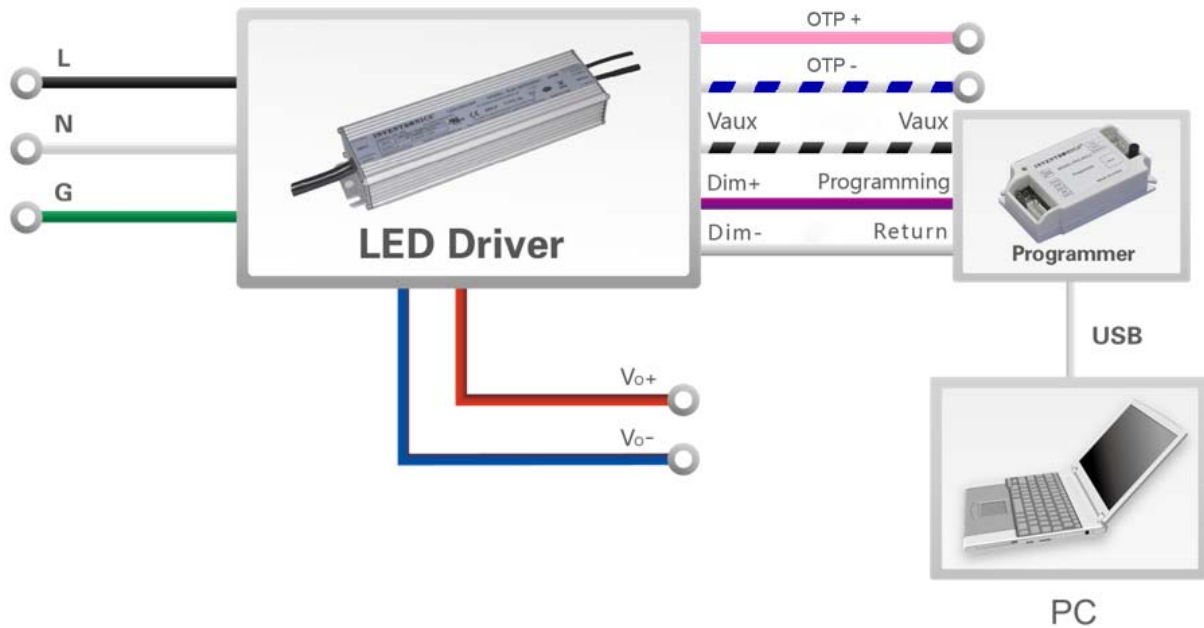

Note: The driver does not need to be powered on during the programming process.

● Please refer to [PRG-MUL2](#) Multi-Programmer datasheet for details.

Mechanical Outline

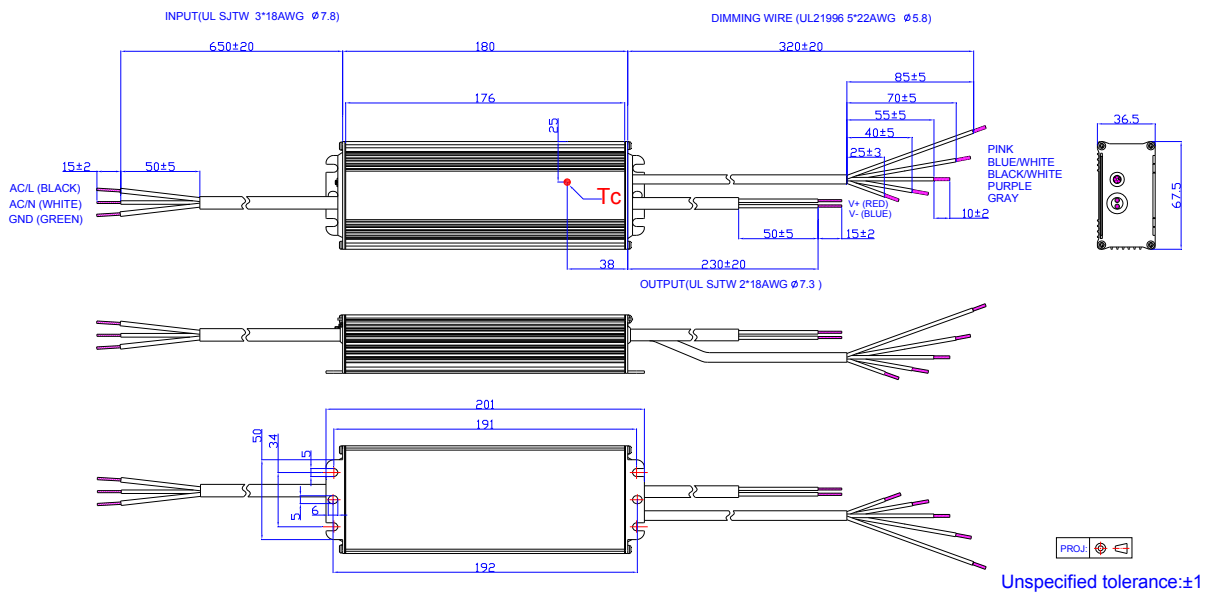

RoHS Compliance

Our products comply with the European Directive 2011/65/EC, calling for the elimination of lead and other hazardous substances from electronic products.

Revision History

Change Date	Rev.	Description of Change		
		Item	From	To
2017-08-09	A	Datasheets Release	/	/
2018-03-01	B	Description		
		Models	EUD-096S215DTL	Add
		I-V Operating Area	EUD-096S215DTL	Add
		Output Specifications	Output Current Setting(Io _{set}) Range	Updated
		Output Specifications	Output Current Setting Range with Constant Power	Updated
		Output Specifications	No Load Output Voltage	Updated
		General Specifications	Efficiency at 120 Vac input:	Updated
		General Specifications	Efficiency at 220 Vac input:	Updated
		General Specifications	Efficiency at 277 Vac input:	Updated
		Dimming Specifications	Dimming Output Range	Updated
		Efficiency vs. Load	EUD-096S215DTL(Io=1750mA) EUD-096S215DTL(Io=2150mA)	Updated
		PWM Dimming	Notes:	Updated
2018-04-13	C	Mechanical Outline	/	Updated