

## Features

- Ultra High Efficiency (Up to 94.5%)
- Full Power at Wide Output Current Range (Constant Power)
- Thermal Sensing and Protection for LED Module
- 0-10V/PWM/3-Timer-Modes Dimmable
- Dim-to-Off with Standby Power  $\leq 0.5$  W
- Always-on Auxiliary Power: 12Vdc, 200mA (Transient Peak Current up to 400mA)
- Output Lumen Compensation
- Input Surge Protection: DM 6kV, CM 10kV
- All-Around Protection: OVP, SCP, OTP
- IP67 and UL Dry / Damp / Wet Location
- SELV Output
- TYPE HL, for use in a Class I, Division 2 hazardous (Classified) location
- 7 Years Warranty



## Description

The EUD-200SxxxDTA series is a 200W, constant-current, programmable LED driver that operates from 90-305 Vac input with excellent power factor. Created for many lighting applications including high bay, high mast, arena and roadway, etc, it provides a dim-to-off mode with low standby power. The high efficiency of these drivers and compact metal case enables them to run cooler, significantly improving reliability and extending product life. To ensure trouble-free operation, protection is provided against input surge, output over voltage, short circuit, and over temperature.

## Models

Adjustable Output Current Range	Full-Power Current Range(1)	Default Output Current	Input Voltage Range(2)	Output Voltage Range	Max. Output Power	Typical Efficiency (3)	Power Factor		Model Number (5)
							120Vac	220Vac	
70-1050mA	700-1050mA	700 mA	90~305 Vac/ 100~300 Vdc	95~286Vdc	200W	94.5%	0.99	0.96	EUD-200S105DTA
140-2100mA	1400-2100mA	1400 mA	90~305 Vac/ 100~300 Vdc	48~143Vdc	200W	94.0%	0.99	0.96	EUD-200S210DTA
245-3500mA	2450-3500mA	2800 mA	90~305 Vac/ 100~300 Vdc	29 ~ 82Vdc	200W	93.5%	0.99	0.96	EUD-200S350DTA <sup>(4)</sup>
385-5600mA	3850-5600mA	4900 mA	90~305 Vac/ 100~300 Vdc	18 ~ 52Vdc	200W	93.0%	0.99	0.96	EUD-200S560DTA <sup>(4)</sup>

**Notes:** (1) Output current range with constant power at 200W.

(2) Certified input voltage range: UL, FCC 100-277Vac or 100-300Vdc; otherwise 100-240Vac or 100-250Vdc (except KS).

(3) Measured at 100% load and 220Vac input (see below "General Specifications" for details).

(4) SELV output.

(5) All the models are certificated to KS, except EUD-200S105DTA.

## I-V Operating Area

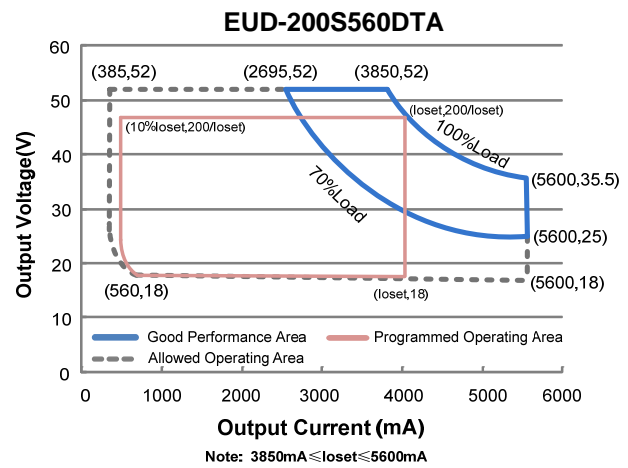
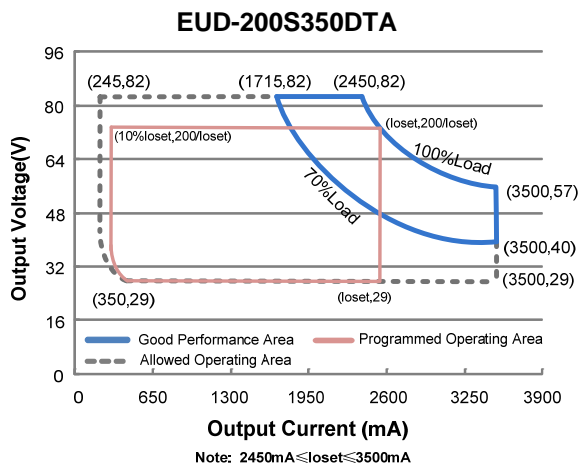
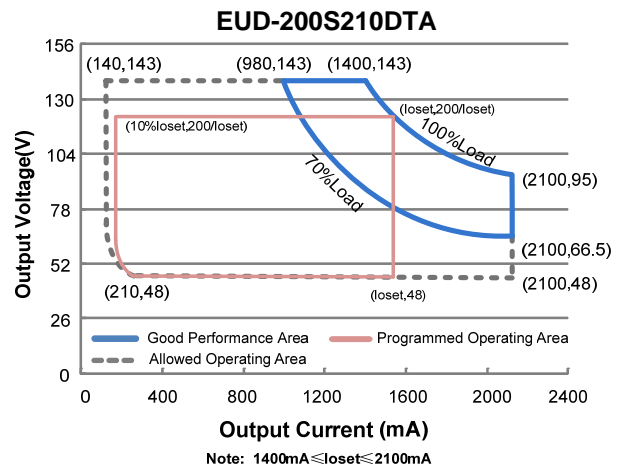
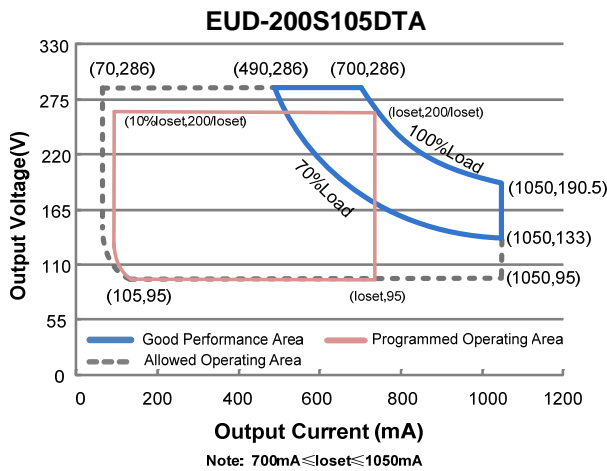

## Input Specifications

Parameter	Min.	Typ.	Max.	Notes
Input Voltage	90 Vac	-	305 Vac	100~300 Vdc
Input Frequency	47 Hz	-	63 Hz	
Leakage Current	-	-	0.75 MIU	UL8750; 277Vac/ 60Hz
	-	-	0.70 mA	IEC60598-1; 240Vac/ 60Hz
Input AC Current	-	-	2.50 A	Measured at 100% load and 100 Vac input.
	-	-	1.10 A	Measured at 100% load and 220 Vac input.
Inrush Current( $I^2t$ )	-	-	2.90 A <sup>2</sup> s	At 220Vac input, 25°C cold start, duration=1.20 ms, 10%Ipk-10%Ipk. See Inrush Current Waveform for the details.
PF	0.90	-	-	At 100-277Vac, 50-60Hz, 70%-100% Load (140-200W)
THD	-	-	20%	
THD	-	-	10%	At 220-240Vac, 50-60Hz, 75%-100% Load (150-200W)

## Output Specifications

Parameter	Min.	Typ.	Max.	Notes
Output Current Tolerance	-5%loset	-	5%loset	At 100% load condition
Output Current Setting(loset) Range				
EUD-200S105DTA	70 mA	-	1050 mA	
EUD-200S210DTA	140 mA	-	2100 mA	
EUD-200S350DTA	245 mA	-	3500 mA	
EUD-200S560DTA	385 mA	-	5600 mA	
Output Current Setting Range with Constant Power				
EUD-200S105DTA	700 mA	-	1050 mA	
EUD-200S210DTA	1400 mA	-	2100 mA	
EUD-200S350DTA	2450 mA	-	3500 mA	
EUD-200S560DTA	3850 mA	-	5600 mA	
Total Output Current Ripple (pk-pk)	-	5%lomax	10%lomax	At 100% load condition, 20 MHz BW
Output Current Ripple at < 200 Hz (pk-pk)	-	2%lomax	-	At 100% load condition. Only this component of ripple is associated with visible flicker.
Startup Overshoot Current	-	-	10%lomax	At 100% load condition
No Load Output Voltage				
EUD-200S105DTA	-	-	330 V	
EUD-200S210DTA	-	-	170 V	
EUD-200S350DTA	-	-	100 V	
EUD-200S560DTA	-	-	60 V	
Line Regulation	-	-	±0.5%	Measured at 100% load
Load Regulation	-	-	±1.5%	
Turn-on Delay Time	-	-	1.0 s	Measured at 120Vac input, 70%-100% Load
	-	-	0.5 s	Measured at 220Vac input, 70%-100% Load
Temperature Coefficient of loset	-	0.03%/°C	-	Case temperature = 0°C ~Tc max
12V Auxiliary Output Voltage	10.8 V	12 V	13.2 V	
12V Auxiliary Output Source Current	0 mA	-	200 mA	Return terminal is "Dim"
12V Auxiliary Output Transient Peak Current	-	-	400 mA	400mA peak for a maximum duration of 300ms in a 2s period during which time the average should not exceed 200mA.

**Note:** All specifications are typical at 25°C unless otherwise stated.

## General Specifications

Parameter	Min.	Typ.	Max.	Notes	
Efficiency at 120 Vac input: EUD-200S105DTA I <sub>o</sub> = 700 mA I <sub>o</sub> = 1050 mA EUD-200S210DTA I <sub>o</sub> = 1400 mA I <sub>o</sub> = 2100 mA EUD-200S350DTA I <sub>o</sub> = 2450 mA I <sub>o</sub> = 3500 mA EUD-200S560DTA I <sub>o</sub> = 3850 mA I <sub>o</sub> = 5600 mA	89.5% 88.5% 89.0% 88.0% 89.0% 87.5% 88.5% 86.5%	91.5% 90.5% 91.0% 90.0% 91.0% 89.5% 90.5% 88.5%	- - - - - - - -	Measured at 100% load and steady-state temperature in 25°C ambient; (Efficiency will be about 2.0% lower if measured immediately after startup.)	
Efficiency at 220 Vac input: EUD-200S105DTA I <sub>o</sub> = 700 mA I <sub>o</sub> = 1050 mA EUD-200S210DTA I <sub>o</sub> = 1400 mA I <sub>o</sub> = 2100 mA EUD-200S350DTA I <sub>o</sub> = 2450 mA I <sub>o</sub> = 3500 mA EUD-200S560DTA I <sub>o</sub> = 3850 mA I <sub>o</sub> = 5600 mA	92.5% 91.0% 92.0% 91.0% 91.5% 90.0% 91.0% 88.5%	94.5% 93.0% 94.0% 93.0% 93.5% 92.0% 93.0% 90.5%	- - - - - - - -		
Efficiency at 277 Vac input: EUD-200S105DTA I <sub>o</sub> = 700 mA I <sub>o</sub> = 1050 mA EUD-200S210DTA I <sub>o</sub> = 1400 mA I <sub>o</sub> = 2100 mA EUD-200S350DTA I <sub>o</sub> = 2450 mA I <sub>o</sub> = 3500 mA EUD-200S560DTA I <sub>o</sub> = 3850 mA I <sub>o</sub> = 5600 mA	92.5% 91.5% 92.5% 91.0% 92.0% 90.5% 91.5% 89.0%	94.5% 93.5% 94.5% 93.0% 94.0% 92.5% 93.5% 91.0%	- - - - - - - -		
Standby power	-	-	0.5 W		Measured at 230Vac/50Hz; Dimming off
MTBF	-	233,000 Hours	-		Measured at 220Vac input, 80%Load and 25°C ambient temperature (MIL-HDBK-217F)
Lifetime	-	108,000 Hours	-		Measured at 220Vac input, 80%Load and 70°C case temperature; See lifetime vs. Tc curve for the details
Operating Case Temperature for Safety Tc <sub>s</sub>	-40°C	-	+89°C		
Operating Case Temperature for Warranty Tc <sub>w</sub>	-40°C	-	+75°C		Case temperature for 7 years warranty. Please see <i>Inventronics Warranty Statement</i> for complete details.
Storage Temperature	-40°C	-	+85°C		Humidity: 5%RH to 100%RH
Dimensions Inches (L × W × H) Millimeters (L × W × H)	8.27 × 2.66 × 1.56 210 × 67.5 × 39.5				With mounting ear 9.10 × 2.66 × 1.56 231 × 67.5 × 39.5

## General Specifications (Continued)

Parameter	Min.	Typ.	Max.	Notes
Net Weight	-	1200 g	-	

**Note:** All specifications are typical at 25°C unless otherwise stated.

## Dimming Specifications

Parameter	Min.	Typ.	Max.	Notes	
Absolute Maximum Voltage on the Vdim (+) Pin	-20 V	-	20 V		
Source Current on Vdim (+)Pin	200 µA	300 µA	450 µA	Vdim(+) = 0 V	
Dimming Output Range	EUD-200S105DTA EUD-200S210DTA EUD-200S350DTA EUD-200S560DTA	10%loset	-	loset	700 mA ≤ loset ≤ 1050 mA 1400 mA ≤ loset ≤ 2100 mA 2450 mA ≤ loset ≤ 3500 mA 3850 mA ≤ loset ≤ 5600 mA
	EUD-200S105DTA EUD-200S210DTA EUD-200S350DTA EUD-200S560DTA	70 mA 140 mA 245 mA 385 mA	-	loset	70 mA ≤ loset < 700 mA 140 mA ≤ loset < 1400 mA 245 mA ≤ loset < 2450 mA 385 mA ≤ loset < 3850 mA
Recommended Dimming Input Range	0 V	-	10 V	Default 0-10V dimming mode.	
Dim off Voltage	0.35 V	0.5 V	0.65 V		
Dim on Voltage	0.55 V	0.7 V	0.85 V		
Hysteresis	-	0.2 V	-		
PWM_in High Level	3 V	-	10 V	Dimming mode set to PWM in PC interface.	
PWM_in Low Level	-0.3 V	-	0.6 V		
PWM_in Frequency Range	200 Hz	-	3 KHz		
PWM_in Duty Cycle	1%	-	99%		
PWM Dimming off (Positive Logic)	2%	5%	8%		
PWM Dimming on (Positive Logic)	4%	7%	10%		
PWM Dimming off ( Negative Logic)	92%	95%	98%		
PWM Dimming on ( Negative Logic)	90%	93%	96%		
Hysteresis	-	2%	-		

**Note:** All specifications are typical at 25 °C unless stated otherwise.

## Safety & EMC Compliance

Safety Category	Standard
UL/CUL	UL8750,CAN/CSA-C22.2 No. 250.13
CE	EN 61347-1, EN61347-2-13

## Safety & EMC Compliance (Continued)

Safety Category	Standard
KS	KS C 7655
EMI Standards	Notes
EN 55015 <sup>(1)</sup>	Conducted emission Test & Radiated emission Test
EN 61000-3-2	Harmonic current emissions
EN 61000-3-3	Voltage fluctuations & flicker
FCC Part 15 <sup>(1)</sup>	ANSI C63.4 Class B
	This device complies with Part 15 of the FCC Rules. Operation is subject to the following two conditions: [1] this device may not cause harmful interference, and [2] this device must accept any interference received, including interference that may cause undesired Operation.
EMS Standards	Notes
EN 61000-4-2	Electrostatic Discharge (ESD): 8 kV air discharge, 4 kV contact discharge
EN 61000-4-3	Radio-Frequency Electromagnetic Field Susceptibility Test-RS
EN 61000-4-4	Electrical Fast Transient / Burst-EFT
EN 61000-4-5	Surge Immunity Test: AC Power Line: Differential Mode 6 kV, Common Mode 10 kV <sup>(2)</sup>
EN 61000-4-6	Conducted Radio Frequency Disturbances Test-CS
EN 61000-4-8	Power Frequency Magnetic Field Test
EN 61000-4-11	Voltage Dips
EN 61547	Electromagnetic Immunity Requirements Applies To Lighting Equipment

**Note:** (1) This LED driver meets the EMI specifications above, but EMI performance of a luminaire that contains it depends also on the other devices connected to the driver and on the fixture itself.

(2) To perform electric strength (hi-pot) testing, the "GDT ground disconnect" (nut and metal lock sheet) on the driver end-cap should be removed temporarily to prevent the internal gas discharge tube from conducting (as allowed by IEC 60598-1 Clause 10.2). After testing is completed, these items must be reinstalled to restore line-to-earth surge protection and secure the end cap.

## Lifetime vs. Case Temperature

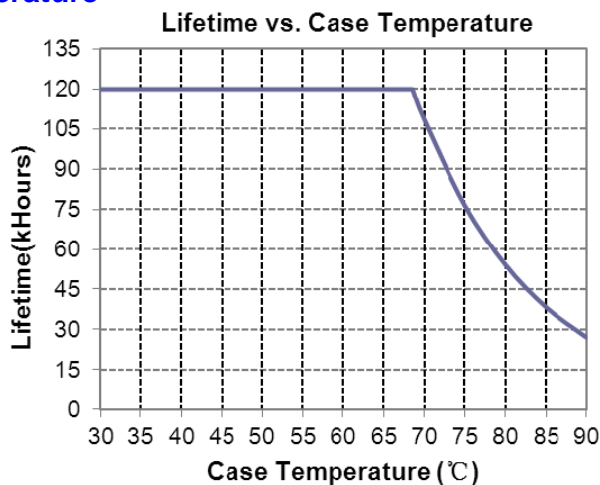

## Inrush Current Waveform

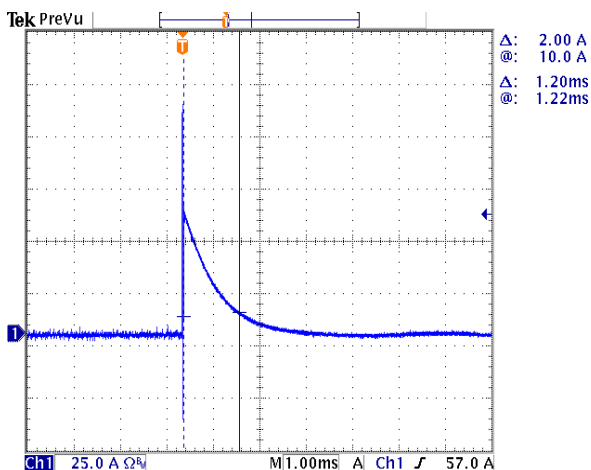

## Efficiency vs. Load

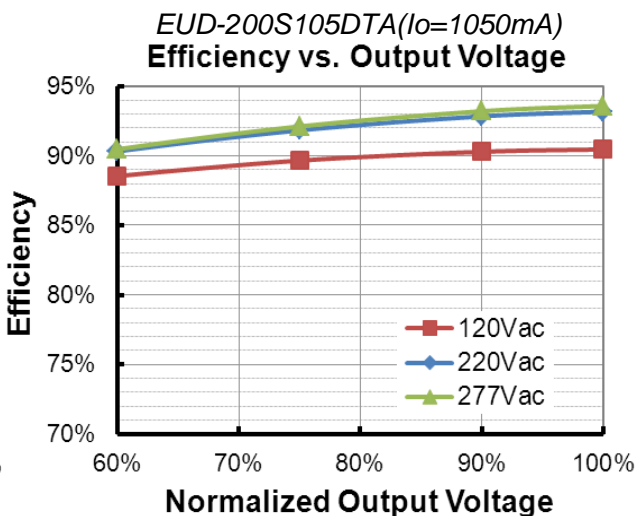
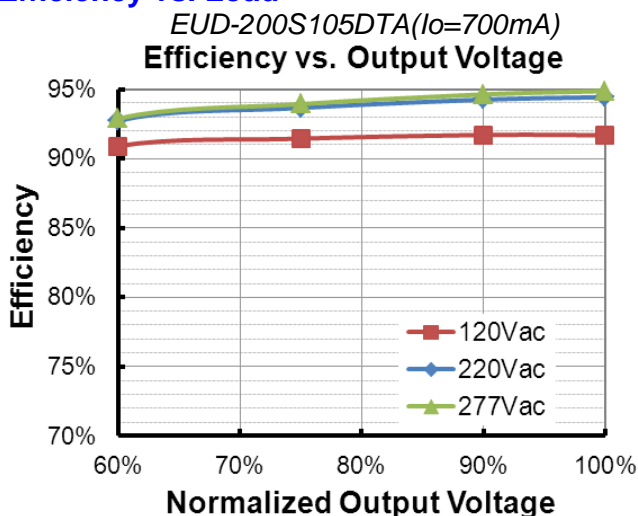

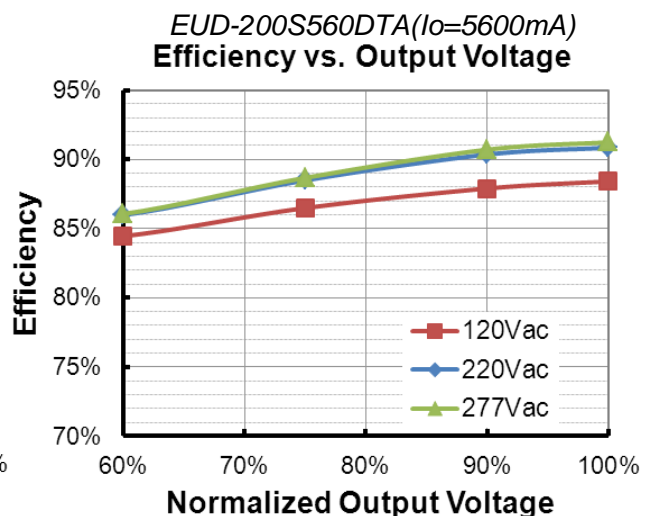
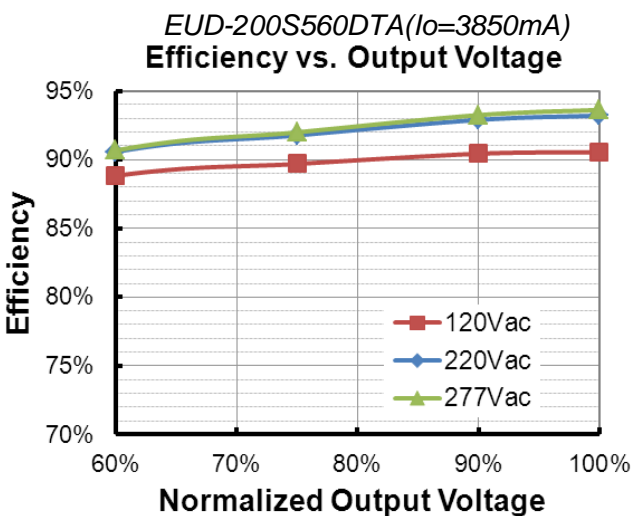
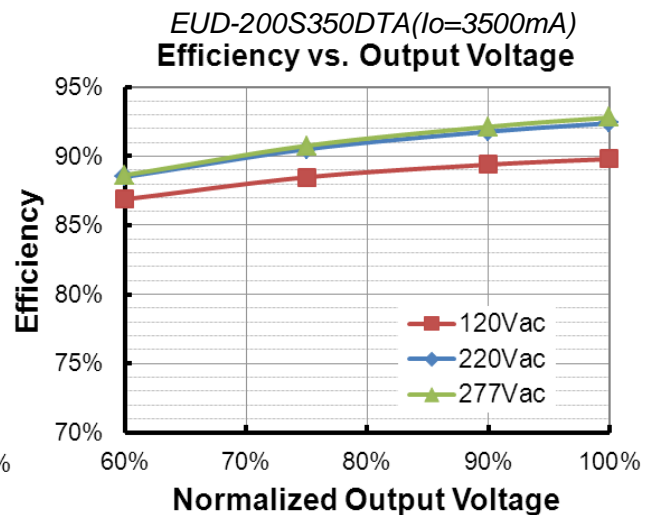
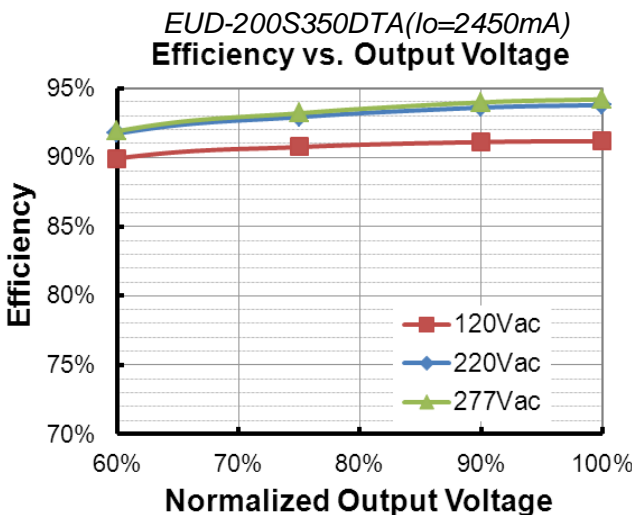
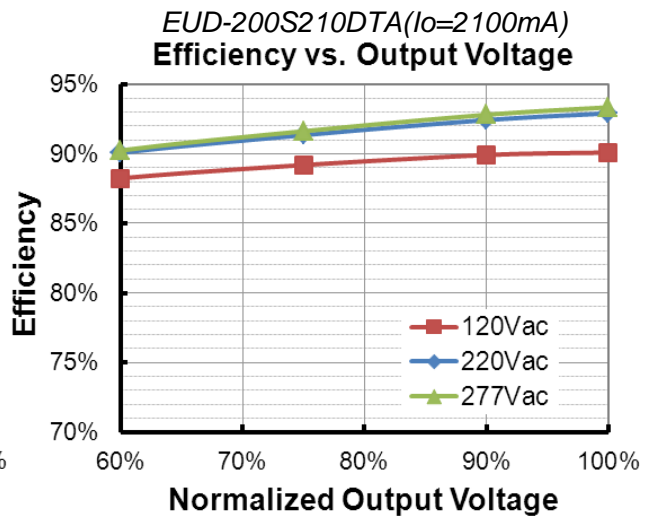
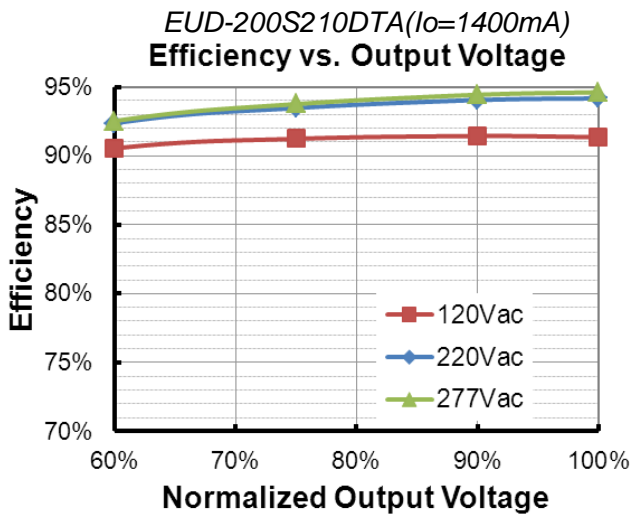

## Power Factor

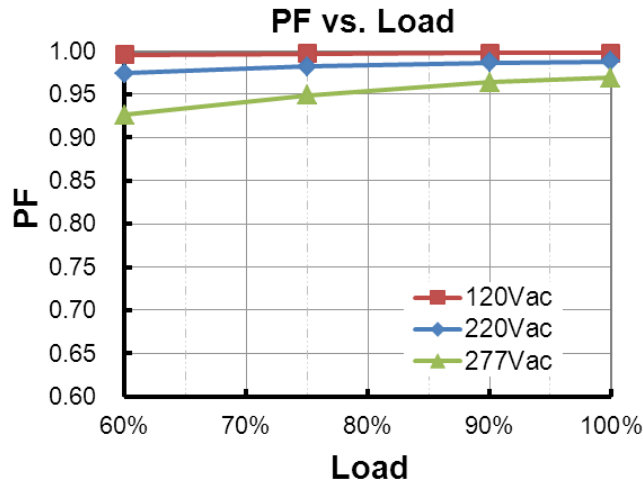

## Total Harmonic Distortion

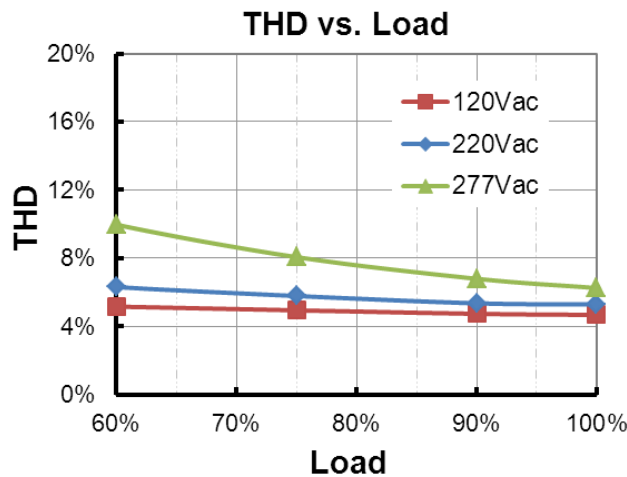

## Protection Functions

Parameter		Min.	Typ.	Max.	Notes
External Thermal Protection NTC	R1	-	7.81 kOhm	-	When R <sub>NTC</sub> falls below R1, External Thermal Protection is triggered, reducing output current until R2 is reached.
	R2	-	4.16 kOhm	-	When R <sub>NTC</sub> is less than R2, output current is reduced to the programmed "Protection Current Floor."
	Protection Current Floor	10% <i>I</i> <sub>oSet</sub>	60% <i>I</i> <sub>oSet</sub>	100% <i>I</i> <sub>oSet</sub>	10% <i>I</i> <sub>oSet</sub> > <i>I</i> <sub>oMin</sub> (default setting is 60%)
<i>I</i> <sub>oMin</sub>		60% <i>I</i> <sub>oSet</sub>	100% <i>I</i> <sub>oSet</sub>	10% <i>I</i> <sub>oSet</sub> ≤ <i>I</i> <sub>oMin</sub> (default setting is 60%)	
Over Temperature Protection		Decreases output current, returning to normal after over temperature is removed.			
Short Circuit Protection		Auto Recovery. No damage will occur when any output is short circuited. The output shall return to normal when the fault condition is removed.			
Over Voltage Protection		Limits output voltage at no load and in case the normal voltage limit fails.			

## Dimming

### ● 0-10V Dimming

The recommended implementation of the dimming control is provided below.

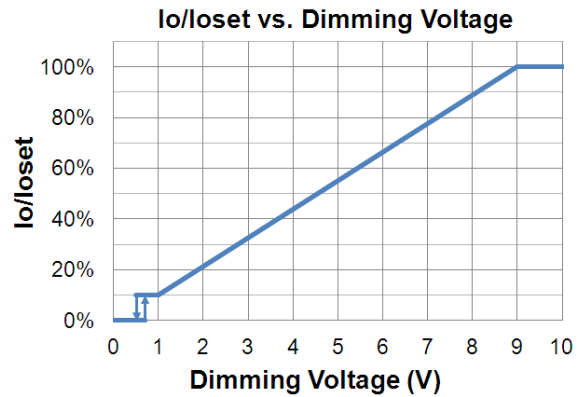
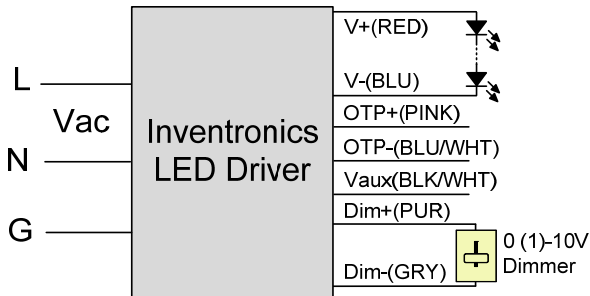

Implementation 1: DC Input

### Notes:

1. The dimmer can also be replaced by an active 0-10V voltage source signal or passive components like resistors and zener.
2. Do NOT connect Dim- to the output V- or V+, otherwise the driver will not work properly.
3. If 0-10V dimming is not used, Dim + should be open.

### ● PWM Dimming

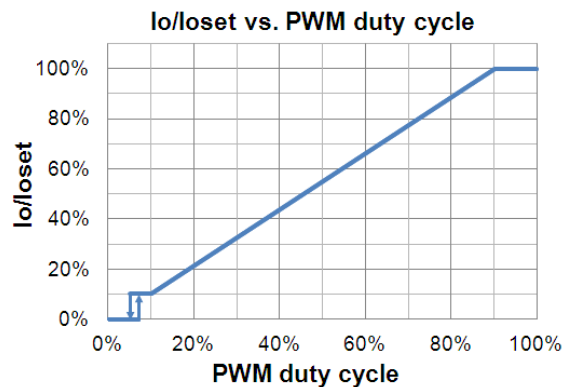
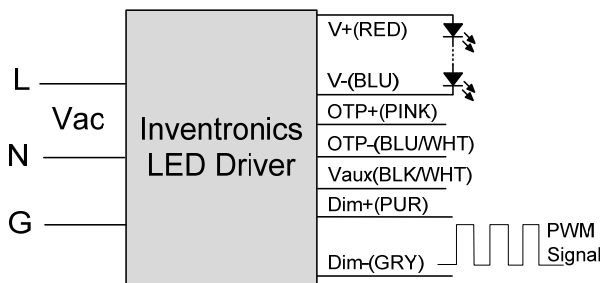

Implementation 2: Positive logic

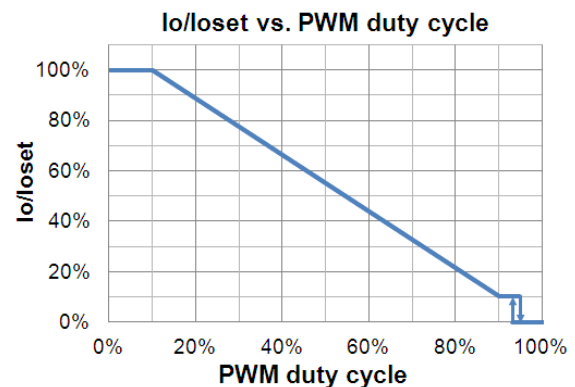
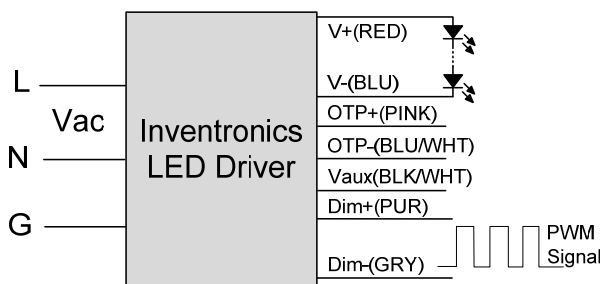

Implementation 3: Negative logic

## ● Time Dimming

Time dimming control includes 3 kinds of modes, they are Self Adapting-Midnight, Self Adapting-Percentage and Traditional Timer.

- **Self Adapting-Midnight:** Automatically adjusts the dimming curve based on the on-time of past two days (if difference <15 minutes), assuming that the center point of the dimming curve is midnight local time.
- **Self Adapting-Percentage:** Automatically adjusts the on-time of each step by a constant percentage = (actual on-time for the past 2 days if difference <15 min) / (programmed on-time from the dimming curve).
- **Traditional Timer:** Follows the programmed timing curve after power on with no changes.

## ● Output Lumen Compensation

Output Lumen Compensation (OLC) may be used to maintain constant light output over the life of the LEDs by driving them at a reduced current when new, then gradually increasing the drive current over time to counteract LED lumen degradation.

## Programming Connection Diagram

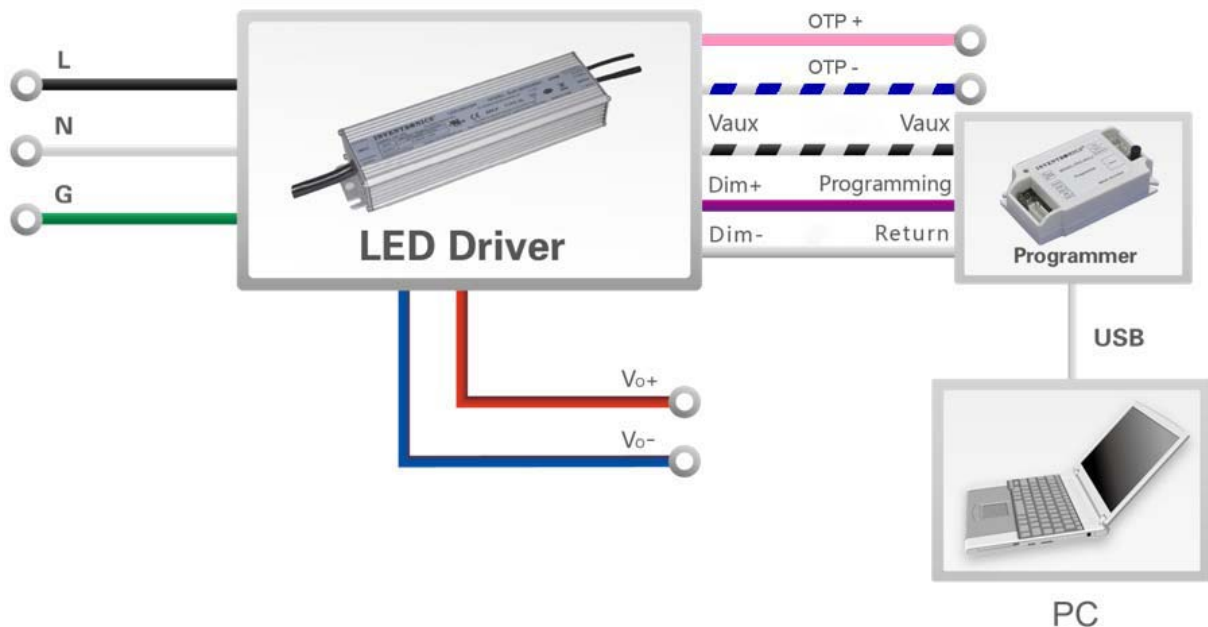

**Note:** The driver does not need to be powered on during the programming process.

- Please refer to [PRG-MUL2](#) (Programmer) datasheet for details.

## Mechanical Outline

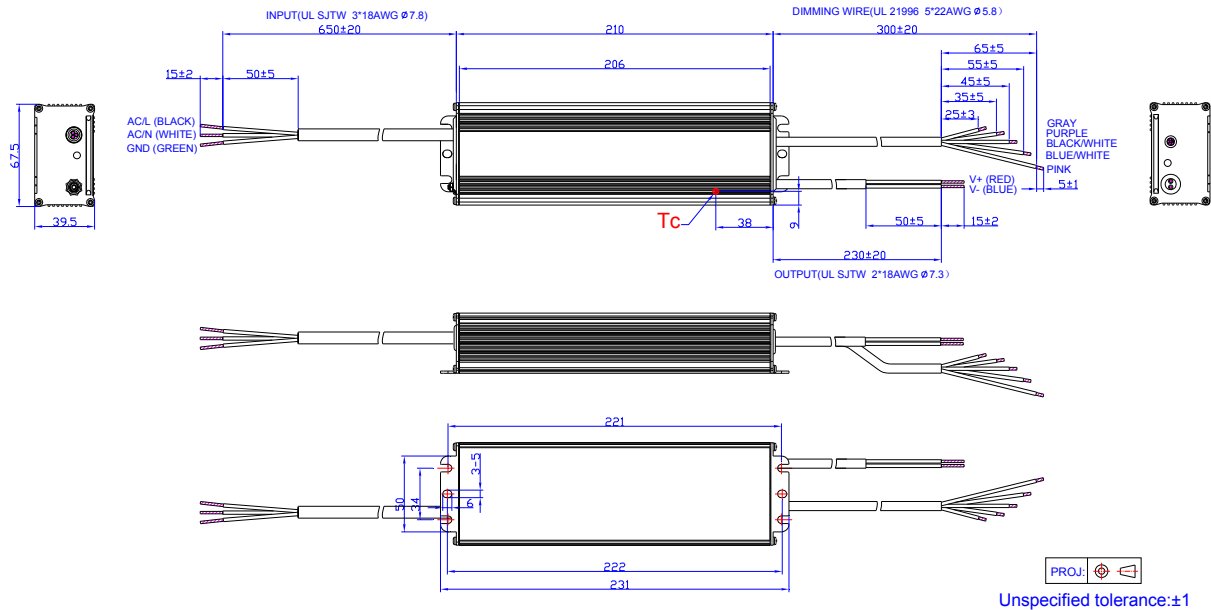

## RoHS Compliance

Our products comply with reference to RoHS Directive (EU) 2015/863 amending 2011/65/EU, calling for the elimination of lead and other hazardous substances from electronic products.

## Revision History

Change Date	Rev.	Description of Change		
		Item	From	To
2016-07-07	A	Datasheets Release	/	/
2017-06-29	B	Features	/	Updated
		Models	/	Updated
		Output Specifications	Temperature Coefficient of loset	/
		Safety &EMC Compliance	/	Updated
		Mechanical Outline	/	Updated
2017-10-26	C	Features	Always-on Auxiliary Power	Added
		Features	7 Years Warranty	Added
		Input Specifications	PF/THD	Updated
		Output Specifications	12V Auxiliary Output Transient Peak Current	Added
		General Specifications	Operating Case Temperature for Warranty Tc_w	Updated
2019-11-07	D	Features	Timer Dimmable (3 Ways of Timers)	3-Timer-Modes Dimmable
		Features	6kV line-line, 10kV line-earth	DM 6kV, CM 10kV
		Features	Waterproof (IP67)	IP67
		Description	Application environment	Updated
		Models- Input –Voltage Range(2)	127~300 Vdc	100~300 Vdc
		Models- Notes(2)	/	Updated
		Input Specifications- Input Voltage	127-300Vdc	100~300Vdc
		Safety &EMC Compliance	EN 61000-4-5	Updated
		RoHS Compliance	/	Updated