



EWAS A Series

LED Wall Pack

The **Evolve**® LED A Series Wall Pack (EWAS), offers Type II, III and IV optical patterns with lumen levels ranging from 3,000 to 17,000 lumens, and is a designed replacement for 50W to 400W HID including an optional Emergency Battery Backup.



Construction

Housing:	Aluminum die cast enclosure. Integral heat sink for maximum heat transfer
Lens:	Impact resistant tempered glass
Paint:	Corrosion resistant polyester powder paint, minimum 2.0 mil thickness Standard = Black, Dark Bronze, Gray & White (RAL & custom colors available)
Weight:	8 - 10 lbs.

Optical System

Lumens:	3,000 - 17,000
Distribution:	Type II, III, IV
CCT:	3000K, 4000K, 5000K
CRI:	≥70

Electrical

Input Voltage:	120-277V & 347-480V
Input Frequency:	50/60Hz
Power Factor:	> 90% at rated watts
Total Harmonic Distortion:	< 20% at rated watts

Surge Protection

TYPICAL (120 STRIKES)	ENHANCED (40 STRIKES)	EXTREME (40 STRIKES)
<input type="checkbox"/> 6kV/3kA*	<input type="checkbox"/> 10kV/5kA*	<input type="checkbox"/> 20kV/10kA*

*Per ANSI C136.2-2015

Warranty

5 Year (Standard)

Lumen Maintenance

Projected Lxx per IES TM-21-11 at 25°C

DISTRIBUTION	LXX(10K) @ HOURS		
	25,000 HR	50,000 HR	60,000 HR
A2, A3, A4, B2, B3, B4, C2, C3, C4, D2, D3, D4	L95	L93	L92
E2, E3, E4, F2, F3, F4, G2, G3, G4	L96	L94	L94

Note: Projected Lxx based on LM80 (≥ 10,000 hour testing). Accepted Industry tolerances apply to initial luminous flux and lumen maintenance measurements.

Luminaire Ambient Temperature Factor

AMBIENT TEMP (°C)	INITIAL FLUX FACTOR	AMBIENT TEMP (°C)	INITIAL FLUX FACTOR
10	1.02	30	0.99
20	1.01	40	0.98
25	1.00	50	0.97

Ratings

Operating Temperature:	-40°C to 40°C
Vibration:	3G per ANSI C136.31-2010
LM-79:	Testing in accordance with IESNA Standards

Controls

Dimming:	Standard - 0-10V <input type="checkbox"/>
	Optional - DALI (Option U) <input type="checkbox"/>
Sensors:	Photo Electric Sensors (PE) available LightGrid+™ and Daintree Compatible

Emergency Battery Backup

Provides reliable emergency operations when there is a loss to normal power, supported by Independent Secondary Battery and LED Board.

Powers luminaire for a minimum of 90 minutes @ 1,000 lumens.

Available on A* and B* Optical Code Packages only

Operating Temperature (for EMBB models) -20° to 40°C

3kV/1.5kA surge protection for EMBB models.

Not all product variations listed on this page are DLC qualified.
Visit www.designlights.org/search to confirm qualifications.



Ordering Information

EWAS 01

7

FM

PROD. ID	GEN	VOLTAGE	OPTIC CODE	DISTRIBUTION	CRI (MIN)	CCT	DIMMING	PE FUNCTION	MOUNTING	COLOR	OPTIONS
E = Evolve	01	0 = 120-277V	Ax = 3000 lm	AF = Asymmetric Forward	7 = 70 CRI	30 = 3000K ¹¹	D = External Dimming leads	1 = None	FM = Surface Mount/Feed Through	BLCK = Black	EMBB = Emergency Batter Backup ^{4,13}
W = Wallpack		H = 347-480V	Bx = 5000 lm	AN = Asymmetric Narrow		40 = 4000K	N = No external Dimming Leads	3 = Button PE ^{12,3}		DKBZ = Dark Bronze	
AS = A-Series			Cx = 7500 lm	AW = Asymmetric Wide		50 = 5000K		A = ANSI C136.41 7-Pin Receptacle		GRAY = Gray	R = Enhanced Surge Protection (10kV/5kA)
		1 = 120V	Dx = 10000 lm					D = ANSI C136.417-Pin Receptacle with Shorting Cap		WHITE = White	T = Extreme Surge Protection (20kV/10kA)
		2 = 208V	Ex = 12200 lm					E = ANSI C136.41 7-Pin with Non-Dimming PE Control ¹²			H = Motion Sensor ^{5,6}
		3 = 240V	Fx = 14400 lm								H2 = Daintree Motion Sensor ^{7,8,9}
		4 = 277V	Gx = 17000 lm								Y = Coastal Finish ¹⁰
		D = 347V									XXX = Special Options
		5 = 480V									F = Fusing

¹ Button PE not available with motion sensor option.

² Only available with discreet voltages.

³ Not available with voltage options 0, H, or 5.

⁴ Available with A and B Optical Codes Only

⁵ H Motion Sensor Bottom mount available with A, B, C, D, & E Optical Codes Only

⁶ H Motion Sensor Side Mount available with F & G Optical Codes Only

⁷ H2 Daintree Motion Sensor Bottom mount available with A, B, C, D, & E Optical Codes Only

⁸ H2 Not Available with F & G Optical Codes

⁹ Not available in 347V, 480V or 347-480V

¹⁰ Recommended for installations within 750 feet from coast. Lead time varies, check with factory.

¹¹ Select 3000K CCT for IDA approved fixtures.

¹² PE Control only available for 120-277V, 347V or 480V Discrete Voltage.

¹³ EMBB is not available with surge protection, fuses or sensors

CUSTOMER NAME _____

PROJECT NAME _____

DATE _____ TYPE _____

CATALOG NUMBER _____

TYPE	OPTIC CODE	DISTRIBUTION	TYPICAL INITIAL LUMENS		TYPICAL SYSTEM WATTAGE		BUG RATINGS	
			3000K	4000K & 5000K	120-277V	347-480V	3000K	4000K & 5000K
							B-U-G	B-U-G
Type IV	A4	Asymmetric Forward (AF)	2900	3000	21	23	B1-U0-G1	B1-U0-G1
	B4		4900	5000	36	38	B1-U0-G1	B1-U0-G1
	C4		7300	7500	56		B1-U0-G2	B1-U0-G2
	D4		9800	10000	77		B2-U0-G2	B2-U0-G2
	E4		11500	12200	89		B2-U0-G2	B2-U0-G2
	F4		13600	14400	109		B2-U0-G2	B2-U0-G2
	G4		16100	17000	130		B3-U0-G3	B3-U0-G3
Type III	A3	Asymmetric Wide (AW)	2900	3000	21	23	B1-U0-G1	B1-U0-G1
	B3		4900	5100	36	38	B1-U0-G1	B1-U0-G1
	C3		7400	7600	56		B2-U0-G1	B2-U0-G1
	D3		9900	10200	77		B2-U0-G2	B2-U0-G2
	E3		11700	12400	89		B2-U0-G2	B2-U0-G2
	F3		13900	14700	109		B2-U0-G2	B2-U0-G2
	G3		16400	17300	130		B2-U0-G2	B3-U0-G2
Type II	A2	Asymmetric Narrow/ Auto (AN)	2900	3000	21	23	B1-U0-G1	B1-U0-G1
	B2		4900	5000	36	38	B1-U0-G1	B1-U0-G1
	C2		7300	7500	56		B2-U0-G1	B2-U0-G2
	D2		9800	10100	77		B2-U0-G2	B2-U0-G2
	E2		11600	12300	89		B2-U0-G2	B2-U0-G2
	F2		13700	14500	109		B3-U0-G3	B3-U0-G3
	G2		16200	17100	130		B3-U0-G3	B3-U0-G3

For additional information on EWAS IES files, please refer to LED.com

EWAS
ASYMMETRIC NARROW
(D2AN750)

10,100 Lumens
5000K
EWAS01_D2AN750_I.E.S

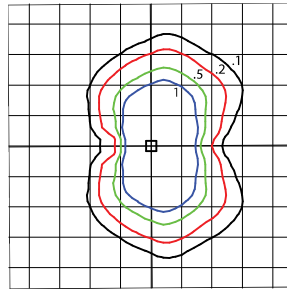

- Mounting Height at 15'
- Initial Footcandle at Grade

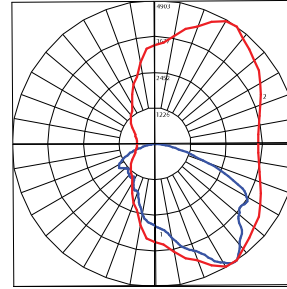

- Vertical plane through horizontal angle of Max. Cd at 55°
- Horizontal cone through vertical angle of Max. Cd at 34°

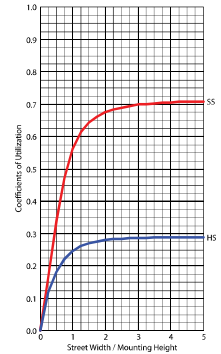

EWAS
ASYMMETRIC WIDE
(D3AW750)

10,200 Lumens
5000K
EWAS01_D3AW750_I.E.S

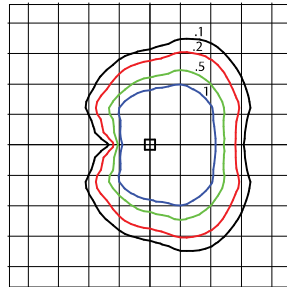

- Mounting Height at 15'
- Initial Footcandle at Grade

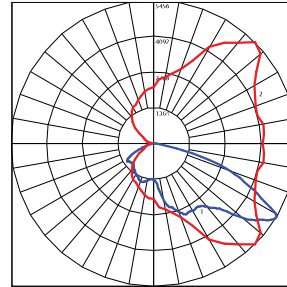

- Vertical plane through horizontal angle of Max. Cd at 45°
- Horizontal cone through vertical angle of Max. Cd at 59°

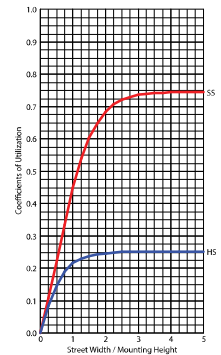

EWAS
ASYMMETRIC FORWARD
(D4AF750)

10,000 Lumens
5000K
EWAS01_D4AF750_I.E.S

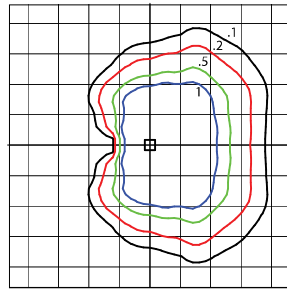

- Mounting Height at 15'
- Initial Footcandle at Grade

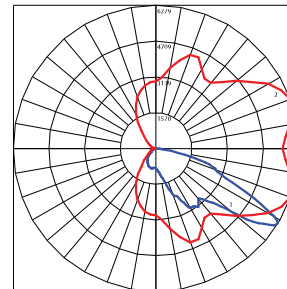

- Vertical plane through horizontal angle of Max. Cd at 20°
- Horizontal cone through vertical angle of Max. Cd at 58°

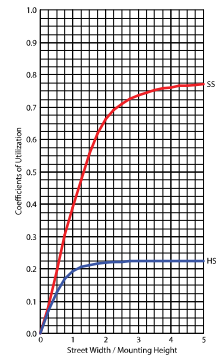

EWAS
ASYMMETRIC NARROW
(G2AN750)

17,100 Lumens
5000K
EWAS01_G2AN750_I.E.S

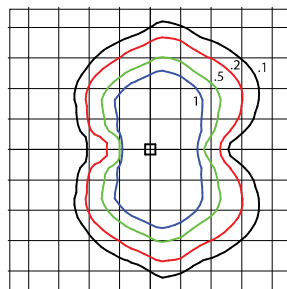

- Mounting Height at 15'
- Initial Footcandle at Grade

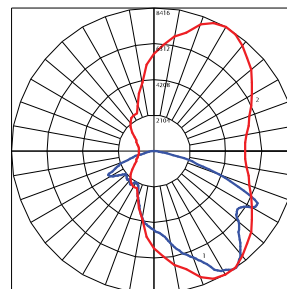

- Vertical plane through horizontal angle of Max. Cd at 60°
- Horizontal cone through vertical angle of Max. Cd at 35°

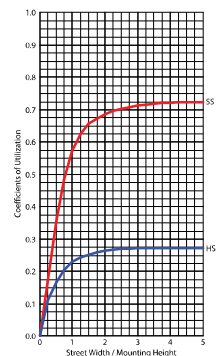

EWAS
ASYMMETRIC WIDE
(G3AW750)

17,300 Lumens
5000K
EWAS01_G3AW750_IES

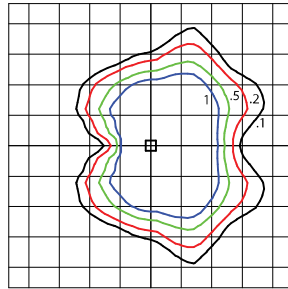

- Mounting Height at 15'
- Initial Footcandle at Grade

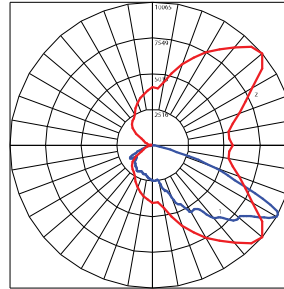

- Vertical plane through horizontal angle of Max. Cd at 40°
- Horizontal cone through vertical angle of Max. Cd at 61°

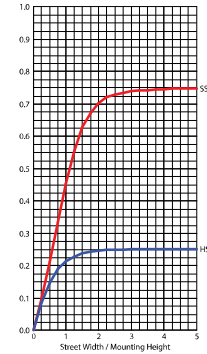

EWAS
ASYMMETRIC FORWARD
(G4AF750)

17,000 Lumens
5000K
EWAS01_G4AF750_IES

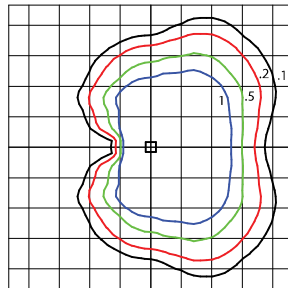

- Mounting Height at 15'
- Initial Footcandle at Grade

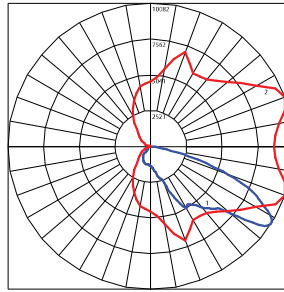

- Vertical plane through horizontal angle of Max. Cd at 20°
- Horizontal cone through vertical angle of Max. Cd at 57°

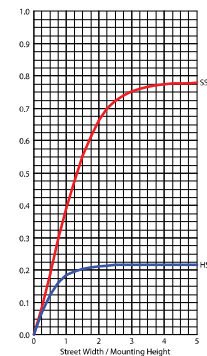

EWAS
(With Emergency Battery
Backup in Operation)

1,000 Lumens
3000K, 4000K, 5000K
EWAS01_With Emergency
Battery Backup On_IES

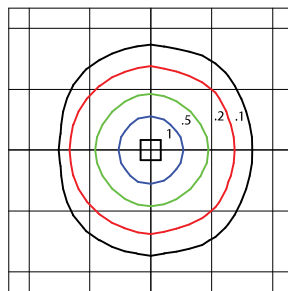

- Mounting Height at 15'
- Initial Footcandle at Grade

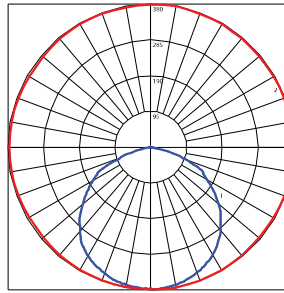

- Vertical plane through horizontal angle of Max. Cd at 80°
- Horizontal cone through vertical angle of Max. Cd at 1°

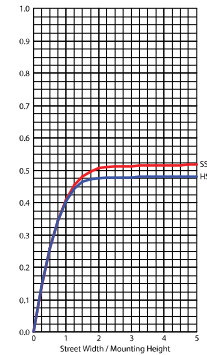

H - Motion Sensing Option

Recommended Mounting Height:	8-25ft
Coverage Radius:	25-30 ft
Lateral Coverage	Provides 180° coverage (180° blocked by wall)
Default Settings	
Output:	Occupied - 100% Unoccupied - 50%
PE Sensor:	Enabled
Ramp/Fade:	10% dimming after 5 minutes with no occupancy
Adds:	Adds < 1W to fixture power rating
Field:	Field programmable using FSIR-100 hand held programmer

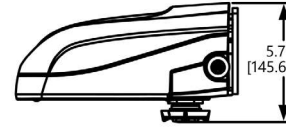
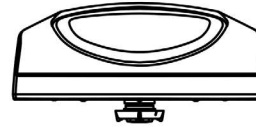

H Option - Wattstopper Motion Sensor
Bottom mount available with A, B, C, D, & E Optical Codes Only

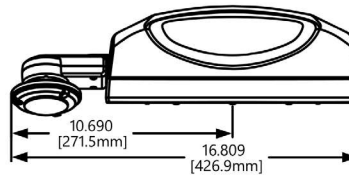

H Option - Wattstopper® Motion Sensor
Side mount available with F & G Optical Codes Only

H2 - Daintree Enabled Motion Sensing Option

Recommended Mounting Height:	8-25ft
Coverage Radius:	15-30 ft
Lateral Coverage	Provides 180° coverage (180° blocked by wall)
Default Settings:	
Output:	Occupied - 100% Unoccupied - 50%
PE Sensor:	Enabled
Ramp/Fade:	5 Minutes/5 Minutes
	Adds < 1W to fixture power rating
	Requires Daintree Enterprise and wide area control (WAC)

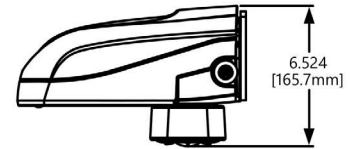
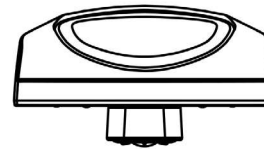

H2 Option - Daintree Motion Sensor
Bottom mount available with A, B, C, D, & E Optical Codes Only

SENSOR PATTERN

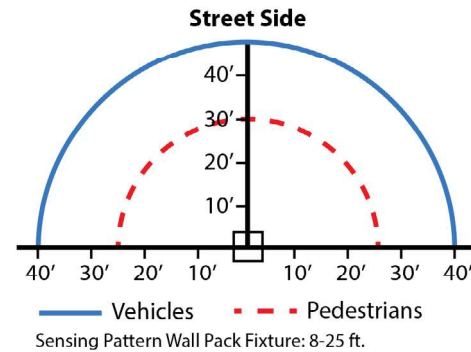

TOP VIEW

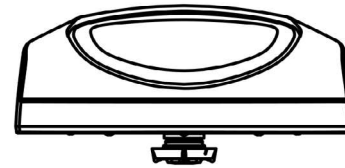
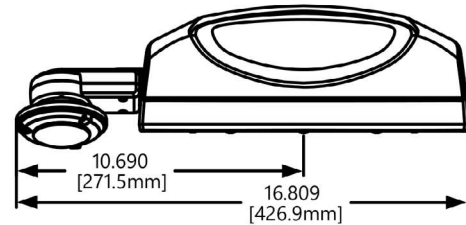
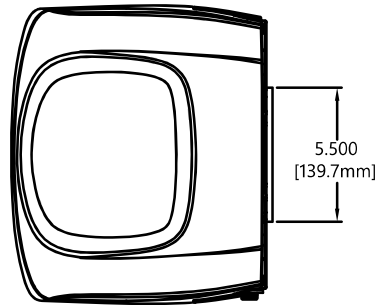

FRONT VIEW

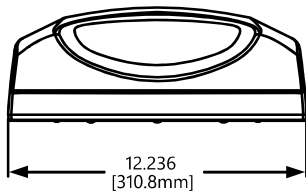

SIDE VIEW

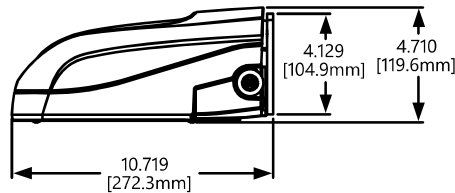

7-PIN RECEPTACLE/ TOP OF LUMINAIRE

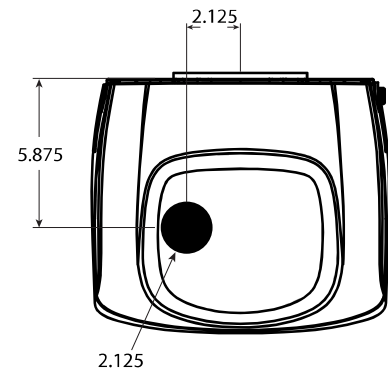
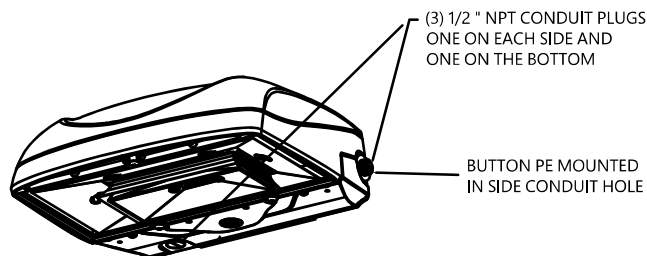

Mounting

- Flush Mount: Mounts directly to customer supplied junction box
- Surface Mount: Mounts to walls via separate mounting holes.
- Adjustable for 1.25 to 1 in. nominal mounting pipe
- Integral diecast mounting pipe stop