

# Evolve® LED Wall Pack

## A Series (EWAS)

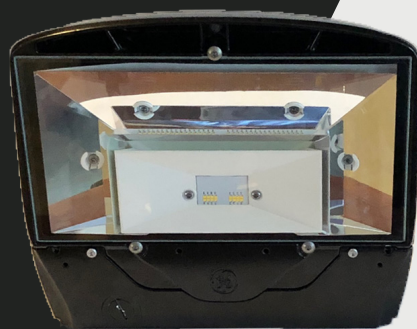

Project Name \_\_\_\_\_

Date \_\_\_\_\_ Type \_\_\_\_\_

Notes \_\_\_\_\_

The **Evolve®** LED A Series Wall Pack (EWAS), offers Type II, III and IV optical patterns with lumen levels ranging from 3,000 to 17,000 lumens, and is a designed replacement for 50W to 400W HID including an optional Emergency Battery Backup.

### CONSTRUCTION

<b>Housing:</b>	Aluminum die cast enclosure. Integral heat sink for maximum heat transfer
<b>Lens:</b>	Impact resistant tempered glass
<b>Paint:</b>	Corrosion resistant polyester powder paint, minimum 2.0 mil thickness Standard = Black, Dark Bronze, Gray & White (RAL & custom colors available)
<b>Weight:</b>	8 - 10 lbs.

### OPTICAL SYSTEM

<b>Lumens:</b>	3,000 - 17,000
<b>Distribution:</b>	Type II, III, IV
<b>CCT:</b>	3000K, 4000K, 5000K
<b>CRI:</b>	≥70

### ELECTRICAL

<b>Input Voltage:</b>	120-277V & 347-480V
<b>Input Frequency:</b>	50/60Hz
<b>Power Factor:</b>	> 90% at rated watts
<b>Total Harmonic Distortion:</b>	< 20% at rated watts

### SURGE PROTECTION

Typical	Enhanced
6kV/3kA*	10kV/5kA*

\*Per ANSI C136.2-2015

### WARRANTY

5 Year (Standard)

### LUMEN MAINTENANCE

Projected Lxx per IES TM-21-11 at 25°C

Distribution	LXX(10K) @ Hours		
	25,000 HR	50,000 HR	60,000 HR
A2, A3, A4, B2, B3, B4, C2, C3, C4, D2, D3, D4	L95	L93	L92
E2, E3, E4, F2, F3, F4, G2, G3, G4	L96	L94	L94

Note: Projected Lxx based on LM80 (≥ 10,000 hour testing). Accepted Industry tolerances apply to initial luminous flux and lumen maintenance measurements.

### LUMINAIRE AMBIENT TEMPERATURE FACTOR

Ambient Temp (°C)	Initial Flux Factor	Ambient Temp (°C)	Initial Flux Factor
10	1.02	30	0.99
20	1.01	40	0.98
25	1.00	50	0.97

### RATINGS

<b>Operating Temperature:</b>	-40°C to 50°C
<b>Vibration:</b>	3G per ANSI C136.31-2010
<b>LM-79:</b>	Testing in accordance with IESNA Standards

### CONTROLS

<b>Dimming:</b>	Standard - 0-10V
<b>Sensors:</b>	Photo Electric Sensors (PE) available LightGrid and Daintree Compatible

### EMERGENCY BATTERY BACKUP

Provides reliable emergency operations when there is a loss to normal power, supported by Independent Secondary Battery and LED Board.

Powers luminaire for a minimum of 90 minutes @ 1,000 lumens.

Available on A\* and B\* Optical Code Packages only

Operating Temperature (for EMBB models) -20° to 40°C

3kV/1.5kA surge protection for EMBB models.

# Evolve® LED Wall Pack

A Series (EWAS)

Catalog Logic

Project Name \_\_\_\_\_

Date \_\_\_\_\_ Type \_\_\_\_\_

Notes \_\_\_\_\_

**EWAS 01**

**7**

**FM**

PROD. ID	GEN	VOLTAGE	OPTIC CODE	DISTRIBUTION	CRI (min)	CCT	CONTROLS	PE FUNCTION	MOUNTING	COLOR	OPTIONS
<b>E = Evolve</b>	01	0 = 120-277	Ax = 3000	AF = Asymmetric Forward	7 = 70 CRI	30 = 3000K <sup>8</sup>	N = No external dimming leads	1 = None	FM = Flush Mount	BLCK = Black	EMBB = Emergency Battery Backup <sup>1,4,9,12</sup>
<b>W = Wallpack</b>		H = 347-480	Bx = 5000	AN = Asymmetric Narrow		40 = 4000K	D = External dimming leads <sup>1</sup>	3 = Button pE <sup>1,2,3,11</sup>		DKBZ = Dark Bronze	R = Enhanced Surge Protection (10kV/5kA)
<b>AS = A-Series</b>			Cx = 7500	AW = Asymmetric Wide		50 = 5000K		A = ANSI C136.41 7-Pin Receptacle		GRAY = Gray	T = Extreme Surge Protection (20kV/10kA)
		1 = 120	Dx = 10000					D = ANSI C136.41 7-Pin Receptacle with Shorting Cap		WHTE = White	H = Motion Sensor (Wattstopper) <sup>5,6,10</sup>
		2 = 208	Ex = 12200					E = ANSI C136.41 7-Pin Receptacle with Non Dimming PE Control			Y = Coastal Finish <sup>7</sup>
		3 = 240	Fx = 14400								XXX = Special Options
		4 = 277	Gx = 17000								
		D = 347									
		5 = 480									

<sup>1</sup> Not available with Option H (Motion Sensor)

<sup>2</sup> Only available with discrete voltages

<sup>3</sup> Not available with Voltage Options 0, H, or 5

<sup>4</sup> Available with A and B Optical Codes Only

<sup>5</sup> H Motion Sensor Bottom mount available with A, B, C, D, & E Optical Codes Only

<sup>6</sup> H Motion Sensor Side Mount available with F & G Optical Codes Only

<sup>7</sup> Recommended for installations within 750 feet from coast. Lead time varies, check with factory

<sup>8</sup> Select 3000K CCT for IDA approved fixtures

<sup>9</sup> Not available with voltage options D, 5, or H

<sup>10</sup> WS FSIR-100 (Sku# 197634) needed for programming sensor

<sup>11</sup> Motion sensor has dusk-to-dawn control functionality

<sup>12</sup> EMBB cannot be used with R (Enhanced Surge 10kV/5kA) or T (Extreme Surge 20kV/10kA)

# Evolve® LED Wall Pack

## A Series (EWAS)

### Spec Tables

Project Name \_\_\_\_\_

Date \_\_\_\_\_ Type \_\_\_\_\_

Notes \_\_\_\_\_

TYPE	OPTIC CODE	DISTRIBUTION	TYPICAL INITIAL LUMENS		TYPICAL SYSTEM WATTAGE		BUG RATINGS	
			3000K	4000K & 5000K	120-277V	347-480V	3000K	4000K & 5000K
							B-U-G	B-U-G
Type IV	A4	Asymmetric Forward (AF)	2900	3000	21	23	B1-U0-G1	B1-U0-G1
	B4		4900	5000	36	38	B1-U0-G1	B1-U0-G1
	C4		7300	7500	56		B1-U0-G2	B1-U0-G2
	D4		9800	10000	77		B2-U0-G2	B2-U0-G2
	E4		11500	12200	89		B2-U0-G2	B2-U0-G2
	F4		13600	14400	109		B2-U0-G2	B2-U0-G2
	G4		16100	17000	130		B3-U0-G3	B3-U0-G3
Type III	A3	Asymmetric Wide (AW)	2900	3000	21	23	B1-U0-G1	B1-U0-G1
	B3		4900	5100	36	38	B1-U0-G1	B1-U0-G1
	C3		7400	7600	56		B2-U0-G1	B2-U0-G1
	D3		9900	10200	77		B2-U0-G2	B2-U0-G2
	E3		11700	12400	89		B2-U0-G2	B2-U0-G2
	F3		13900	14700	109		B2-U0-G2	B2-U0-G2
	G3		16400	17300	130		B2-U0-G2	B3-U0-G2
Type II	A2	Asymmetric Narrow (AN)	2900	3000	21	23	B1-U0-G1	B1-U0-G1
	B2		4900	5000	36	38	B1-U0-G1	B1-U0-G1
	C2		7300	7500	56		B2-U0-G1	B2-U0-G2
	D2		9800	10100	77		B2-U0-G2	B2-U0-G2
	E2		11600	12300	89		B2-U0-G2	B2-U0-G2
	F2		13700	14500	109		B3-U0-G3	B3-U0-G3
	G2		16200	17100	130		B3-U0-G3	B3-U0-G3

For additional information on EWAS IES files, please click the following link:

[EWAS IES Files](#)

# Evolve® LED Wall Pack

## A Series (EWAS)

### Photometric Plots

Project Name \_\_\_\_\_

Date \_\_\_\_\_ Type \_\_\_\_\_

Notes \_\_\_\_\_

#### EWAS ASYMMETRIC NARROW (D2AN750)

10,100 Lumens  
5000K

EWAS01\_D2AN750\_IES

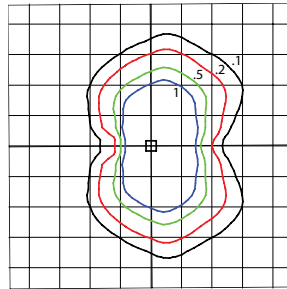

- Mounting Height at 15'
- Initial Footcandle at Grade

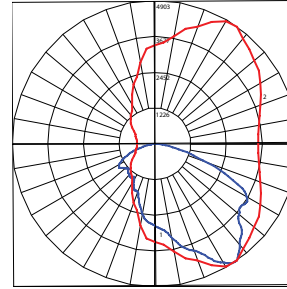

- Vertical plane through horizontal angle of Max. Cd at 55°
- Horizontal cone through vertical angle of Max. Cd at 34°

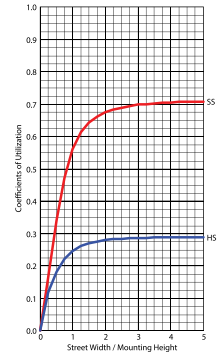

#### EWAS ASYMMETRIC WIDE (D3AW750)

10,200 Lumens  
5000K

EWAS01\_D3AW750\_IES

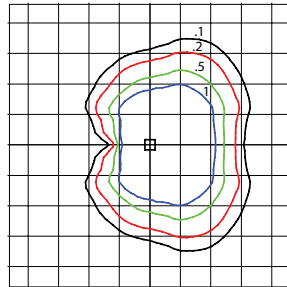

- Mounting Height at 15'
- Initial Footcandle at Grade

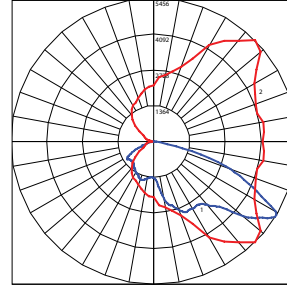

- Vertical plane through horizontal angle of Max. Cd at 45°
- Horizontal cone through vertical angle of Max. Cd at 59°

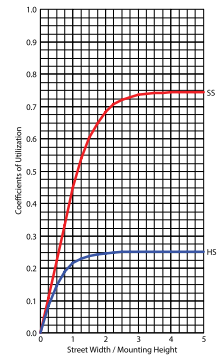

#### EWAS ASYMMETRIC FORWARD (D4AF750)

10,000 Lumens  
5000K

EWAS01\_D4AF750\_IES

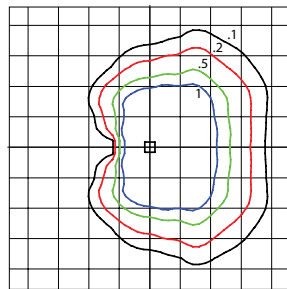

- Mounting Height at 15'
- Initial Footcandle at Grade

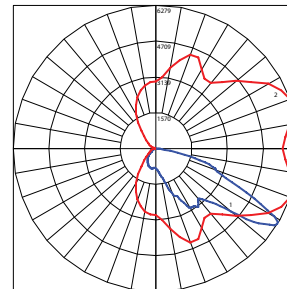

- Vertical plane through horizontal angle of Max. Cd at 20°
- Horizontal cone through vertical angle of Max. Cd at 58°

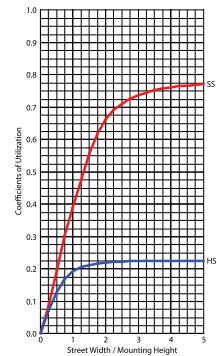

#### EWAS ASYMMETRIC NARROW (G2AN750)

17,100 Lumens  
5000K

EWAS01\_G2AN750\_IES

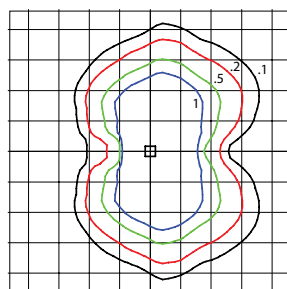

- Mounting Height at 15'
- Initial Footcandle at Grade

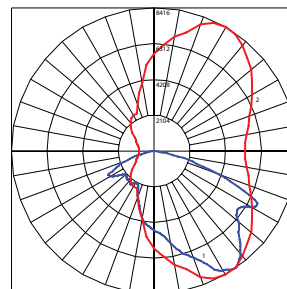

- Vertical plane through horizontal angle of Max. Cd at 60°
- Horizontal cone through vertical angle of Max. Cd at 35°

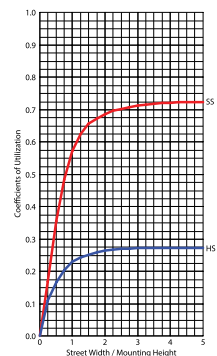

# Evolve® LED Wall Pack

## A Series (EWAS)

### Photometric Plots

Project Name \_\_\_\_\_

Date \_\_\_\_\_ Type \_\_\_\_\_

Notes \_\_\_\_\_

**EWAS**  
ASYMMETRIC WIDE  
(G3AW750)  
  
17,300 Lumens  
5000K  
EWAS01\_G3AW750\_IES

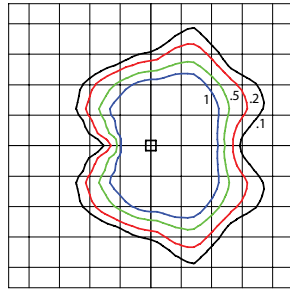

- Mounting Height at 15'
- Initial Footcandle at Grade

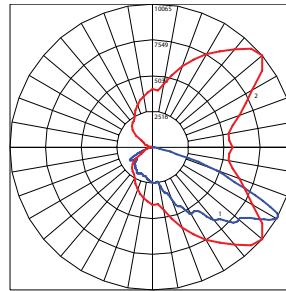

- Vertical plane through horizontal angle of Max. Cd at 40°
- Horizontal cone through vertical angle of Max. Cd at 61°

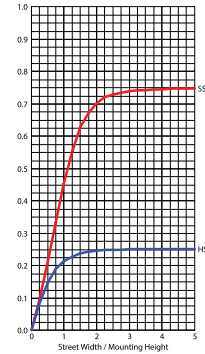

**EWAS**  
ASYMMETRIC FORWARD  
(G4AF750)  
  
17,000 Lumens  
5000K  
EWAS01\_G4AF750\_IES

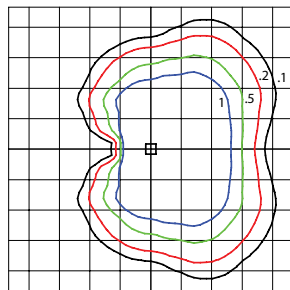

- Mounting Height at 15'
- Initial Footcandle at Grade

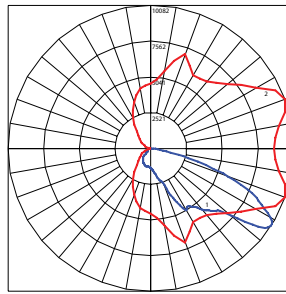

- Vertical plane through horizontal angle of Max. Cd at 20°
- Horizontal cone through vertical angle of Max. Cd at 57°

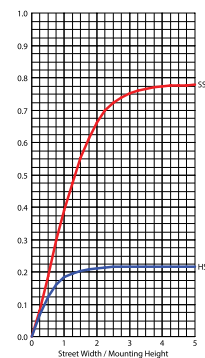

**EWAS**  
(With Emergency Battery  
Backup in Operation)  
  
1,000 Lumens  
3000K, 4000K, 5000K  
EWAS01\_With Emergency  
Battery Backup On\_IES

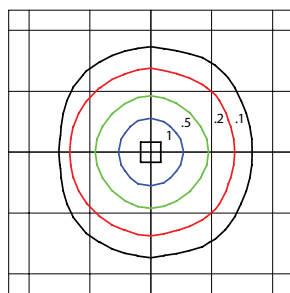

- Mounting Height at 15'
- Initial Footcandle at Grade

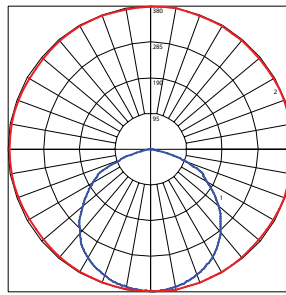

- Vertical plane through horizontal angle of Max. Cd at 80°
- Horizontal cone through vertical angle of Max. Cd at 1°

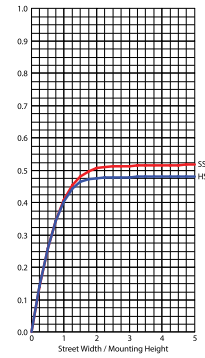

# Evolve® LED Wall Pack

A Series (EWAS)

Motion Sensing

Project Name \_\_\_\_\_

Date \_\_\_\_\_ Type \_\_\_\_\_

Notes \_\_\_\_\_

## H MOTION SENSING OPTION

<b>Recommended Mounting Height:</b>	8-25ft
<b>Coverage Radius:</b>	25-30 ft
<b>Lateral Coverage</b>	Provides 180° coverage (180° blocked by wall)
<b>Default Settings</b>	
<b>Output:</b>	Occupied - 100% Unoccupied - 50%
<b>PE Sensor:</b>	Enabled
<b>Ramp/Fade:</b>	10% dimming after 5 minutes with no occupancy
	Adds < 1W to fixture power rating
	Field programmable using FSIR-100 hand held programmer SKU # 197634 (WS FSIR-100)

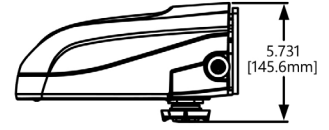
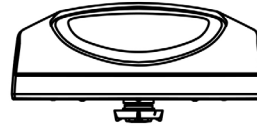

**H Option - Wattstopper Motion Sensor**  
Bottom mount available with A, B, C, D, & E Optical Codes Only

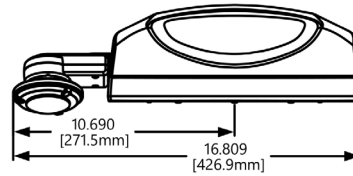

**H Option - Wattstopper® Motion Sensor**  
Side mount available with F & G Optical Codes Only

## SENSOR PATTERN\*

### Coverage Top View @ 12ft.

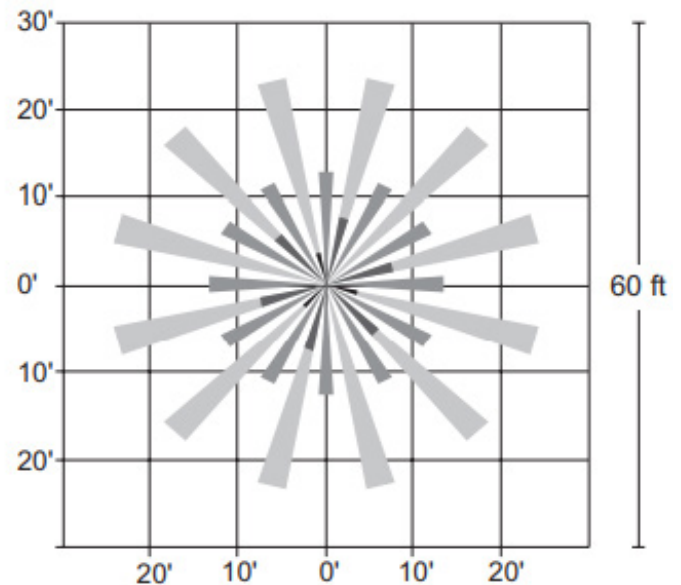

\* Image used with permission from Catalog Number: FSP-L2/FSP-L3/FSP-L7

For additional information on Wattstopper® products please click the following link:

[Wattstopper® Coverage Guide](#)

# Evolve® LED Wall Pack

A Series (EWAS)

Mounting & Accessories

Project Name \_\_\_\_\_

Date \_\_\_\_\_ Type \_\_\_\_\_

Notes \_\_\_\_\_

## TOP VIEW

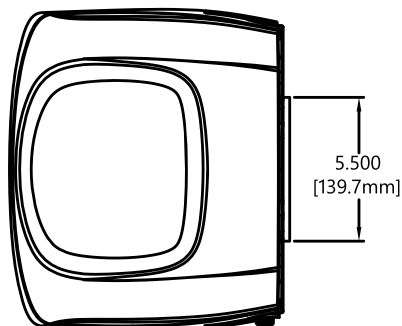

## FRONT VIEW

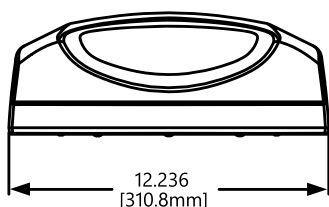

## SIDE VIEW

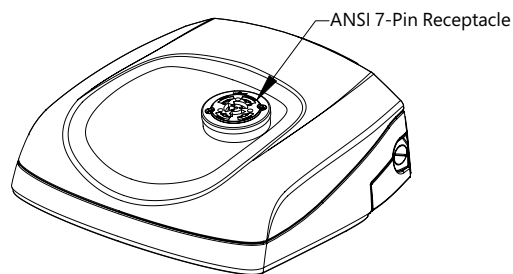
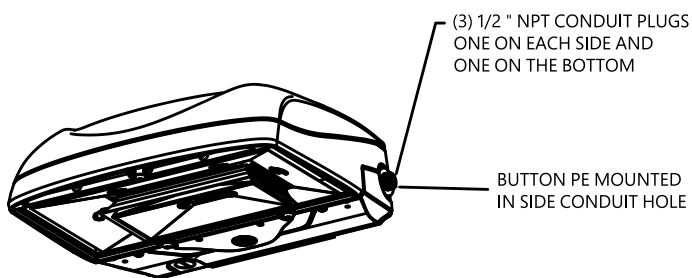
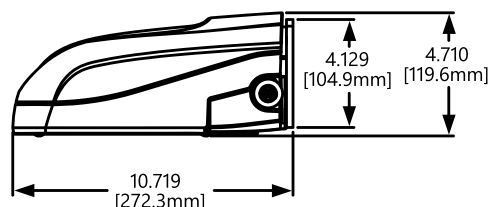

## MOUNTING

- Flush Mount: Mounts directly to customer supplied junction box
- Surface Mount: Mounts to walls via separate mounting holes.