

HCL Select

LED Selectable High Bay Gen 2 **CONTRACTOR XP**

Due to continuous product improvements, specification and/or equipment updates may change without notice.



Pending for HCL LS240 model



(Images are shown for illustration purposes only)

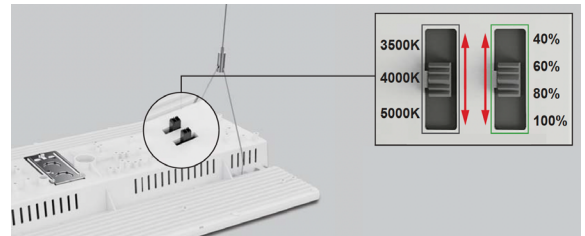

HCL Select (HCL LS360 model)

CCT Color and Lumen/Wattage Selectable Switches

The **HCL Selectable Linear High Bay** is compact, light weight, powerhouse of a linear highbay. Switch selectable driver allows for a future-proof investment so that your lighting needs continue to be met offering a range of lumen outputs and color options. A tough housing design and easy installation makes the **HCL Select** a contractor's dream come true at a price that'll drive away the competition. It's simple, with the **HCL Select LED Linear High Bay** - your experience matters.

Catalog Number	Description	Lumens	Watts	CCT	Voltage
HCL LS240 G2 FSK	HCL Compact High Bay, 4 Level Wattage Adjustable, Gen 2, CCT Selectable, White finish	Selectable 12,000 - 24,000 Lm	Selectable 85 - 160 W	Selectable 3500K - 5000K	120V - 277V
HCL LS240 G2 HVU FSK	HCL Compact High Bay, 4 Level Wattage Adjustable, Gen 2, CCT Selectable, White finish	Selectable 12,000 - 24,000 Lm	Selectable 85 - 160 W	Selectable 3500K - 5000K	347V - 480V
HCL LS360 G2 FSK	HCL Compact High Bay, 4 Level Wattage Adjustable, Gen 2, CCT Selectable, White finish	Selectable 18,000 - 38,100 Lm	Selectable 115- 260 W	Selectable 3500K - 5000K	120V - 277V
HCL LS360 G2 FSK-EMD-SH20D-UNV-260	HCL Compact High Bay, 4 Level Wattage Adjustable, Gen 2, CCT Selectable with pre-installed Emergency Battery Backup, White finish	Selectable 18,000 - 38,100 Lm	Selectable 115- 260 W	Selectable 3500K - 5000K	120V - 277V
HCL LS360 G2 HVU FSK	HCL Compact High Bay, 4 Level Wattage Adjustable, Gen 2, CCT Selectable, White finish	Selectable 18,000 - 38,100 Lm	Selectable 115- 260 W	Selectable 3500K - 5000K	347V - 480V

ORDERING GUIDE

Example: HCL LS360 G2 FSK

Fixture Type	Selectable Lumen Output	Generation	Voltage	Selectable CCT	Finish	Options - Emergency Backup	Options - Controls	Options - Accessories
<ul style="list-style-type: none"> HCL Compact High Bay 	<ul style="list-style-type: none"> LS240 12,000 Lm / 84 W 14,000 Lm / 100 W 18,000 Lm / 130 W 24,000 Lm / 160 W LS360 18,900 Lm / 115 W 26,300 Lm / 165 W 32,900 Lm / 220 W 38,100 Lm / 260 W 	<ul style="list-style-type: none"> G2 Second Generation 	<ul style="list-style-type: none"> BLANK 120-277 V HVU 347-480 V 	<ul style="list-style-type: none"> FSK 3500K 4000K 5000K 	<ul style="list-style-type: none"> BLANK White 	<ul style="list-style-type: none"> BLANK No backup. ES-EIA32-01S* Emergency backup, field installed (120-277V). EMD-SH20D-UNV-260* Emergency backup (120-277V). EMA-LH40D-HVU-400* Emergency backup (40W) for HVU model only, no sensor option, pendant mount only. 	<ul style="list-style-type: none"> BLANK None Bluetooth Controls MSB-DCE-06 <i>OSLG sync</i> Bluetooth motion sensor L3 Medium Bay lens L7 High Bay lens FCB-DCE-02 <i>OSLG sync</i> Bluetooth Plug-in Controller Node Basic Controls MS-DCE-07 Motion sensor MS-20-L7 High bay lens RM-51 Remote control for motion sensor. 	<ul style="list-style-type: none"> BLANK None HCL-SMB Surface Mount Kit HCL-PMB Pendant Mount Kit WG-HCL11 Wire guard for HCL LS240 WG-HCL12A Wire guard for HCL LS360 SPD-277 Surge protector (120-277V) SPD-480 Surge protector (for HVU model) CS1 6' Straight Blade Plug (120-277V) CS2 6' Twist-Lock Plug (120-277V) CS3 6' 600V 14/2 MC Solid Cable - no plug CS4 6' 600V SO Black Cord, no plug, 18/3 CS5 6' 18 Gauge, 5 Conductors, no plug

*Not available for the HCL LS240

Performance Information

Series Number	Power Percentage	Wattage	3500K		4000K		5000K	
			LUMENS	LPW	LUMENS	LPW	LUMENS	LPW
HCL LS240	100%	160 W	24,000 Lm	150 Lm/W	25,000 Lm	156 Lm/W	24,500 Lm	142 Lm/W
	80%	130 W	18,000 Lm	138 Lm/W	19,000 Lm	146 Lm/W	18,500 Lm	142 Lm/W
	60%	100 W	14,000 Lm	140 Lm/W	15,000 Lm	150 Lm/W	14,500 Lm	145 Lm/W
	40%	85 W	12,000 Lm	141 Lm/W	13,000 Lm	153 Lm/W	12,500 Lm	147 Lm/W
HCL LS360	100%	260 W	36,000 Lm	138 Lm/W	38,100 Lm	147 Lm/W	37,000 Lm	142 Lm/W
	80%	210 W	31,000 Lm	148 Lm/W	32,900 Lm	157 Lm/W	31,900 Lm	152 Lm/W
	60%	165 W	25,000 Lm	152 Lm/W	26,300 Lm	159 Lm/W	25,500 Lm	155 Lm/W
	40%	115 W	18,000 Lm	157 Lm/W	18,900 Lm	164 Lm/W	18,300 Lm	159 Lm/W

Specifications

Housing

One-piece die-cast aluminum for quality and performance.

Ambient Temperature

Suitable for use in -40° C to 50° C (-40° F to 122° F).
With Emergency Backup: 5° C to 50° C (41° F to 122° F).

Mounting

Steel wire cable mount (default), surface mount, and pendent installation with conduit.

Efficacy

Up to 164 lumens per watt.

CCT and CRI

Field selectable: 3500K, 4000K, and 5000K.
CRI 80.

Lumen Output

Field selectable: 12,000 - 38,100 Lm.

Warranty

10-year limited warranty. Comprehensive warranty terms can be located on www.slgus.com.

Electrical

Standard 120V - 277V

0-10V dimming standard with a dimming range of 100% to 10%.

HVU High Voltage 347V - 480V

Certifications

UL Listed for damp locations. FCC compliant. Design Lights Consortium® (DLC) Premium 5.1 listed pending.

Dimensions

HCL Select

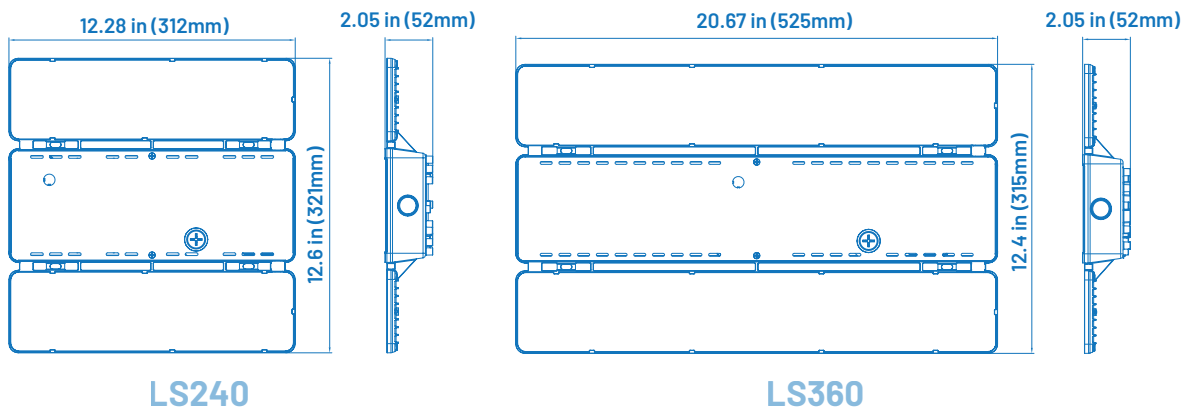

HCL Select



Photometric

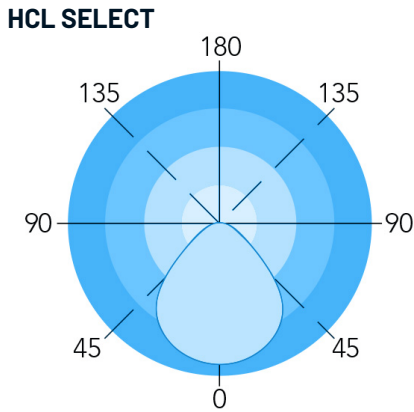

Emergency ⚡ Backup Specs

INPUT

100-347 V AC

OUTPUT

90-260 V DC

OUTPUT POWER

20 W

Mounting

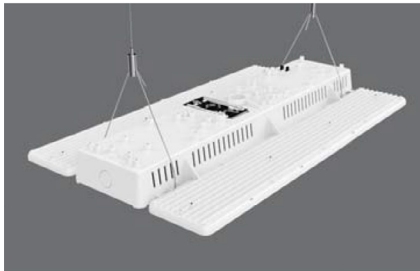

Standard Aircraft Cable Mounting
(Accessories included)

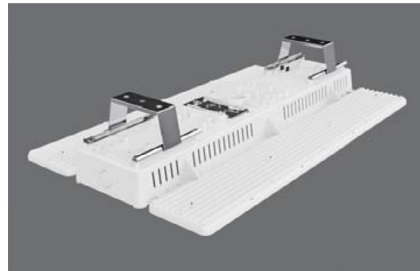

Surface Mount

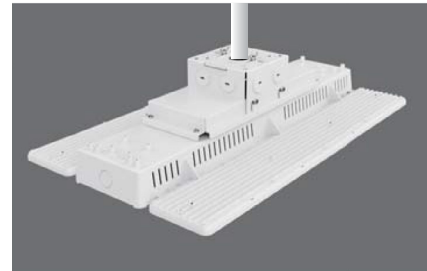

Conduit Pendant Mount

Accessories



MSB-DCE-06

Bluetooth Motion Sensor with controller



FCB-DCE-02

Bluetooth Controller



HCL-PMB

Pendant with 3/4" conduit

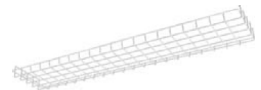

Wire Guard

Electrical Load

	Power Setting	Wattage	Current (A)				HVU	Current (A)	
			120V	208V	240V	277V		347V	480V
HCL LS240	Low	85 W	0.71	0.41	0.35	0.35		0.25	0.18
	Med	100 W	0.83	0.48	0.42	0.36		0.29	0.21
	High	130 W	1.1	0.63	0.54	0.47		0.37	0.27
	Max	160 W	1.33	0.77	0.67	0.58		0.46	0.33
HCL LS360	Low	115 W	0.96	0.55	0.48	0.42		0.33	0.24
	Med	165 W	1.38	0.79	0.69	0.60		0.48	0.34
	High	210 W	1.75	1.01	0.88	0.76		0.61	0.44
	Max	260 W	2.17	1.25	1.08	0.94		0.75	0.54

Shipping Information



Product Number	Individual Box Size	Individual Box Weight	# Per Carton	# Per Pallet
HCL LS240 G2 FSK	14.57" x 13.19" x 2.36"		1	-
HCL LS360 G2 FSK	12.4" x 2" x 20.7"	6.34 lbs	1	138
HCL LS360 G2 FSK-EMD-SH20D-UNV-260	13" x 2.4" x 22.8"	8.34 lbs	1	-

Bluetooth Motion sensor



MSB-DCE-06
(Pictured with L7 lens)

Specifications:

Input Voltage
DC 12V

IP Rating
IP66

Input Current
50mA Max

Input Power
0.6 W

Output Voltage
DC 10V

Output Current
10mA Max

Output Power
0.1W

Sinking Current
10mA Max

Bluetooth Transmit
200 ft. Max

Radio Frequency
2.4 GHz +- 75 MHz

Mounting Height
20 - 40 ft

Dimming
Class 2, 0-10V DC 10mA Max

Detection Range
40 - 80 ft

Operating Temperature
-30°C to 55°C (-22°F to 131°F)

Warranty
5 Year warranty

Commissioning

This Bluetooth sensor/controller is easily commissioned via the SLG Sync app, available for download on Google Play and the App Store.

App Download:



For commissioning guide and more information visit:

www.slgsync.com

Basic Motion sensor



MS-DCE-07
(Pictured with L7 lens)

Specifications:

Input Voltage
DC 12V

Input Current
8mA

Input Power
0.1 W

Output Current
10mA Max

Output Power
0.1W

Sinking Current
10mA Max

IP Rating
IP66

Detection Range
40-80 ft

Mounting Height
20-40 ft

Dimming
Class 2, 0-10V DC 10mA Max

Operating Temperature
-30°C to 70°C (-22°F to 158°F)

Warranty
5 Year warranty

Commissioning

This basic sensor is commissioned via the RM51 remote. Either pre-commissioned or commissioned on site.

