

High Center Beam Round Recessed Adjustable

4"



OVERVIEW

Feature Set

- Nine optimized distribution patterns allow designers to achieve tailored objectives
- Vertical tilt is self-locking from 0° - 40° with indicator arrow and gauge; 365° of horizontal rotation.
- Cut cones enable optimal efficacies while also occluding the inside of the fixture.
- Bounding Ray™ optical design
- 45° Cutoff to source and source image
- Field interchangeable optic
- Driver and LED light engine fully serviceable from below ceiling
- 70% lumen maintenance at 60,000 hours
- 2.5 SDCM; 85 CRI typical, 90+ CRI optional

Distribution



Superior Performance

Nominal Lumens	500	750	1000	1500	2000	2500	3000	3500	4000	4500	5000
Delivered	618	710	934	1359	1739	2128	2569	3121	3503	3887	4265
Wattage	6.7	7.5	9.8	15.1	21.5	26.5	34.1	33.8	39.5	46.2	53.2
Efficacy	92	95	95	90	81	80	75	92	89	84	80

*Based on 3500K 80CRI 35D AR T00 LSS @ 0 Degrees

COMPLEMENTARY PRODUCTS

Coordinated Apertures | Multiple Layers of Light



General Illumination Layer | EVO



High Center Beam Layer | Incito



EVO + Incito — Multiple Layers of Light

Core



Healthcare



Special Applications



Luminaire Type:

Catalog Number:

EXAMPLE: IC04ADJ 35/15 AR T00 LSS 35D 277 EZ1

Series	Color Temperature	Lumens	Reflector Color	Cut Cone	Flange Type	Reflector Finish
IC04ADJ Incito 4in Round Recessed Adjustable	27/ 2700 K	05 500 lumens	AR Clear	T00 Cut for angles 0°-15°	(blank) Self-flanged	LSS Semi-specular
	30/ 3000 K	07 750 lumens	PR Pewter	T30 Cut for angles 15°-30°	FL ^{9,10} Flangeless	LD Matte diffuse
	35/ 3500 K	10 1000 lumens	WTR Wheat	T40 Cut for angles 25°-40°		
	40/ 4000 K	15 1500 lumens	GR Gold			
	50/ 5000 K	20 2000 lumens	WR ¹ White painted			
		25 2500 lumens	BR ¹ Black			
		30 3000 lumens	BZR ¹ Dark Bronze painted			
		35 3500 lumens	WRAMF ¹ White Anti-microbial			
		40 4000 lumens				
		45 4500 lumens				
	50 5000 lumens					

Beam	Voltage	Driver	Control Interface	Options
10D ² 10° beam angle	120 120V	GZ10 0-10V driver dims to 10%. Max: 3500LM	(blank)	SF Single fuse.
15D 15° beam angle	277 277V	GZ1 0-10V driver dims to 1%. Max: 3500LM	NLT ⁷ nLight® dimming pack.	90CRI High CRI (90+)
20D 20° beam angle	347 ^{3,4} 347V	EZ10 eldoLED 0-10V ECOdrive. Linear dimming to 10% min.	NLTER ^{7,8} nLight® dimming pack for fixtures on emergency circuit	CP ¹¹ Chicago Plenum
25D 25° beam angle		EZ1 eldoLED 0-10V ECOdrive. Linear dimming to 1% min.	NLTAIR2 nLight® AIR dimming pack.	TRW ⁹ White Painted Flange
30D 30° beam angle		EZB eldoLED 0-10V SOLOdrive. Logarithmic dimming to <1%.	NLTAIRER2 ⁸ nLight® AIR dimming pack for fixtures on emergency circuit	TRBL ¹⁰ Black Painted Flange
35D 35° beam angle		EDAB ⁶ eldoLED SOLOdrive DALI. Logarithmic dimming to <1%.	NLTAIREM2 nLight® AIR dimming pack for fixtures on emergency circuit	N80 nLight Lumen Compensation
40D 40° beam angle		EDXB ^{5,6} eldoLED POWERdrive DMX with RDM (remote device management). Square Law dimming to <1%. MIN:1000 MAX:4000		RRL RELOC® Ready Luminaire connectors enable a simple and consistent factory installed option across all ABL luminaire brands. Available only with RRLA, RRLB, RRLAE, and RRLC12S. Refer to RRL spec sheet on www.acuitybrands.com for RELOC® product specifications. Above ceiling access required.
45D 45° beam angle		ECOD ⁵ Lutron® EcoSystem® digital Hi-Lume 1% soft-on, fade to black. Min: 500LM; Max: 4000LM.		
50D 50° beam angle				

ACCESSORIES —order as separate catalog numbers (shipped separately)

OPTC4 XXD Additional optics for field installation. Replace "XX" with beam angle.

ORDERING NOTES

- Not Available with Finishes.
- Only available 1500lm and below.
- Not available with ELR emergency option.
- Supplied with factory installed step down transformer.
- Includes terminator resistor.
- Not Available with Control Interfaces.
- Must specify 120 or 277.
- For use with generator supply EM power. Will require an emergency hot feed and normal hot feed.
- For use with different reflector finish only (i.e. AR, PR, WTR, GR options). Not available with WR (White Reflector).
- For use with different reflector finish only (i.e. AR, PR, WTR, GR options). Not available with BR (Black Reflector).
- CP only available up to 3000 lumens. Specify 120 or 277

Optical and Trim Assembly

Fully serviceable and upgradeable lensed LED light engine suitable for field maintenance or service from above or below the ceiling. Optical design is a Bounding Ray™ design with 45° cutoff to source and source image. Top down flash characteristic for superior glare control. Vertical tilt is self-locking from 0° - 40° with indicator arrow and gauge, engages with a manual tilt locking screw for added aiming assurance. Cut cones enable optimal efficacies while also occluding the inside of the fixture. 365° of horizontal rotation enabled through self-lubricating polymer which never binds or deforms. Cam lock locks rotation to ensure integrity of design throughout lifetime of luminaire.

Electrical

The luminaire shall operate from a 50 or 60 Hz ±3 Hz AC line over a voltage ranging from 120 VAC to 277 VAC. Support 347V via fixture-mounted stepdown transformer. The fluctuations of line voltage shall have no visible effect on the luminous output. The luminaire shall have a power factor of 90% or greater at all standard operating voltages and full luminaire output. Sound Rated A+. Driver shall be >80% efficient at full load across all input voltages. Input wires shall be 18AWG, 300V minimum solid copper. All drivers are ROHS compliant.

Controls

Luminaire shall be equipped with interface for nLight wired or nLight AIR networks with integral power supply as per specification.

Emergency

Luminaires supplied with a battery pack comply with NFPA 101 (Life Safety code) and deliver constant light output throughout the 90 minutes of code required emergency operation period when there is a normal AC power loss with remote test switch available.

Dimming

The luminaire shall be capable of continuous dimming without perceivable stroboscopic flicker as measured by flicker index (ANSI/IES RP-16-10) over a range of 100 – 10%, 100 – 1.0% or 100 – 0.1% of rated lumen output with a smooth shut off function to step to 0%. eldoLED LED drivers shall conform to IEEE P1789 standards. Alternatively, manufacturers must demonstrate conformance with product literature and testing which demonstrates this performance. Systems that do not meet IEEE P1789 will not be considered. Driver is inaudible in 24dB environment, and stable when input voltage conditions fluctuate over what is typically experienced in a commercial environment.

Construction

Light engine and driver are accessible from above or below ceiling. 16-gauge black painted steel mounting frame with mounting bars included. Post-installation adjustment possible from above or below ceiling. Galvanized steel junction box with hinged access covers and spring latch. Three combination 1/2"-3/4" and one 1/2" knockout for straight-through conduit runs. Capacity: 8 (4 in, 4 out) No. 12 AWG conductors rated for 90°C. Accommodates up to 5/8"-thick ceilings.

Listings

Fixtures are CSA Certified to meet US and Canadian Standards: All fixtures manufactured in strict accordance with the appropriate and current requirements of the "Standards for Safety" to UL, damp location listed. IC-rated up to 1500 lumens.

Government Procurement

BAA - Buy America(n) Act: Product qualifies as a domestic end product under the Buy American Act as implemented in the FAR and DFARS. Product also qualifies as manufactured in the United States under DOT Buy America regulations
 BABA - Build America Buy America: Product qualifies as produced in the United States under the definitions of the Build America, Buy America Act
 Please refer to www.acuitybrands.com/buy-american for additional information.

Photometrics

LEDs tested to LM-80 standards. Measured by IESNA Standard LM-79-08 in an accredited lab. Lumen output shall not decrease by more than 30% over the minimum operational life of 60,000 hours. Color appearance from luminaire to luminaire of the same type and in all configurations, shall be consistent both initially and at 60,000 hours and operate within a tolerance of <2.5 MacAdam ellipse as defined by the center of the quadrangles defined in ANSI C78.377-2015.

Warranty

5-year limited warranty. This is the only warranty provided and no other statements in this specification sheet create any warranty of any kind. All other express and implied warranties are disclaimed. Complete warranty terms located at: www.acuitybrands.com/support/warranty/terms-and-conditions

Note:

Actual performance may differ as a result of end user environment and application. All values are design or typical values, measured under laboratory conditions at 25 °C.

A+ Capable Luminaire

This item is an A+ capable luminaire, which has been designed and tested to provide consistent color appearance and out-of-the-box control compatibility with simple commissioning when used with Acuity Brands controls products.
All configurations of this luminaire are calibrated and tested to meet the Acuity Brands' specifications for chromatic consistency – including color rendering, color fidelity, and color temperature tolerance around standard CIE chromaticity coordinates.

To learn more about Acuity A+ standards, specifications, and testing, visit www.acuitybrands.com/aplus.

IC0 - eldoLED Driver Default Dimming Curve			
Nomenclature	Min Dimming	Driver Dim Curve	Control Dim Curve
EZ10	10%	Linear	Linear/Logarithmic
EZ1	1%	Linear	Linear/Logarithmic
EZB	<1%	Logarithmic	Linear
EDAB	<1%	Logarithmic*	Linear
EDXB	<1%	Square	Linear

*Changable through DALI controller

Lumen Output Multiplier		
CRI	CCT	Multiplier
80	2700K	0.916
	3000K	0.948
	3500K	1
	4000K	1.032
	5000K	1.1
90	2700K	0.748
	3000K	0.8
	3500K	0.838
	4000K	0.845
	5000K	0.945

Reflector Finish Multiplier	
Reflector Finish	Multiplier
LS - Specular	1
LSS - Semi Specular	0.956
WR - White	0.87
LD - Matte Diffuse	0.85
BR - Black	0.73
BZR - Bronze	0.73

Driver		Control Provided				
Nomenclature	Description	NLT	NLTER	NLTAIR2	NLTAIREM2	NLTAIRER2
GZ10	0-10V driver dims to 10%	nPP16 D EFP	nPP16 D ER EFP	RPP20 D 24V G2	RPP20 D 24V EM G2	RPP20 D 24V ER G2
GZ1	0-10V driver dims to 1%	nPP16 D EFP	nPP16 D ER EFP	RPP20 D 24V G2	RPP20 D 24V EM G2	RPP20 D 24V ER G2
EZ10	eldoLED 0-10V ECOdrive	nPS 80 EZ	nPS 80 EZ ER	RPP20 D 24V G2	RPP20 D 24V EM G2	RPP20 D 24V ER G2
EZ1	eldoLED 0-10V ECOdrive	nPS 80 EZ	nPS 80 EZ ER	RPP20 D 24V G2	RPP20 D 24V EM G2	RPP20 D 24V ER G2
EZB	eldoLED 0-10V SOLOdrive	nPS 80 EZ	nPS 80 EZ ER	RPP20 D 24V G2	RPP20 D 24V EM G2	RPP20 D 24V ER G2

Marked Spacing in Inches 25°C Ambient			
Lumen Package	Fixed Center to Center MIN	Fixture Center to Building Member MIN	Space Above Fixture
3000-5000 (All driver options)	24	12	0.5

DIMENSIONAL DATA

*Dimensions in inches [centimeters]

Aperture: 4-5/16 [11]

Ceiling Opening: 5-1/8 [13] self-flanged

Overlap Trim: 5-7/16 [13.8]

Ceiling Opening: 4-5/8 [11.7] flangeless

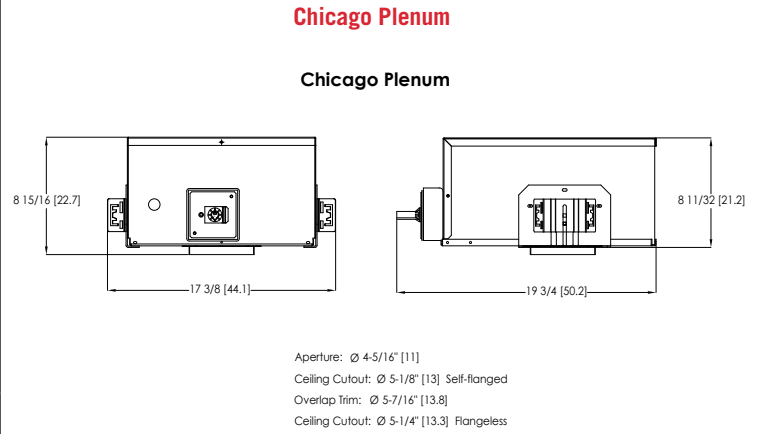
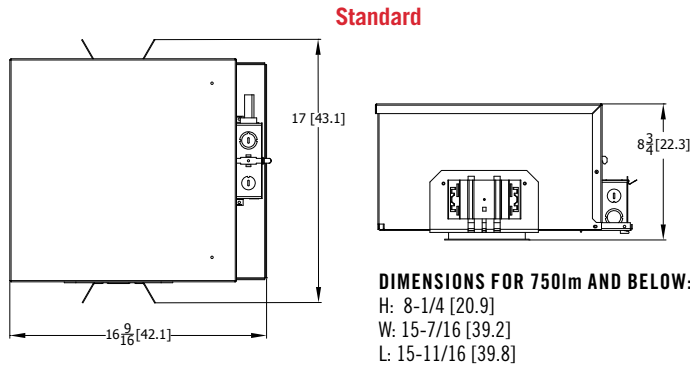

T00 Cut Cone for 0° - 15° Tilt

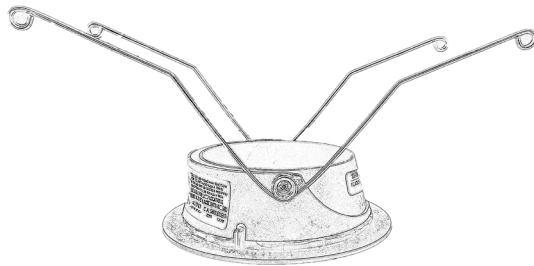

T30 Cut Cone for 15° - 30° Tilt

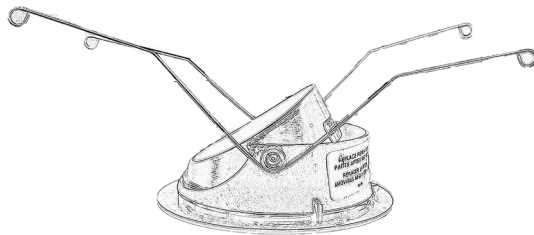

T40 Cut Cone for 26° - 40° Tilt

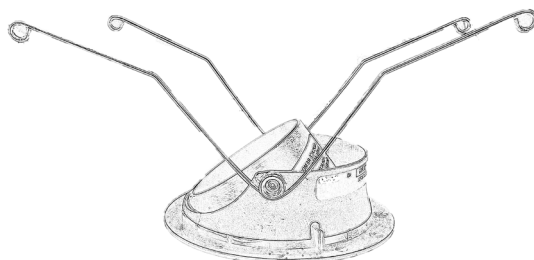

Photometry

CONSULT WWW.GOTHAMLIGHTING.COM FOR ADDITIONAL PHOTOMETRY

ICO4ADJ 35/15 AR T00 LSS 15D at 0DEG Input Watts: 15.1, Delivered Lumens: 1399, LPW: 92.6, S/MH: 0.31, Test No: ISF 193855P101

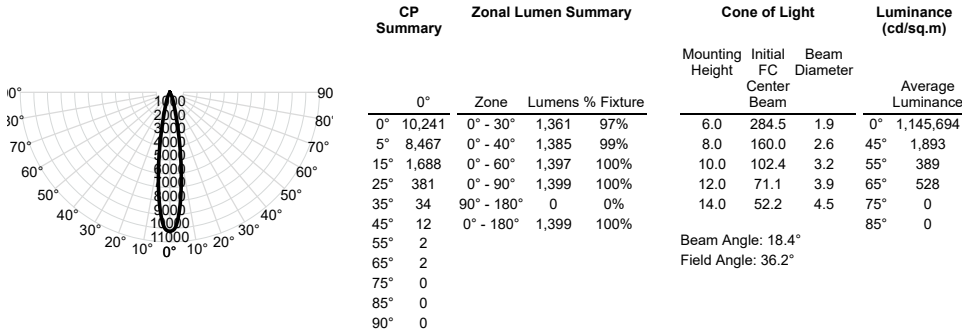

ICO4ADJ 35/15 AR T00 LSS 30D at 0DEG Input Watts: 15.1, Delivered Lumens: 1264, LPW: 83.7, S/MH: 0.50, Test No: ISF 193858P101

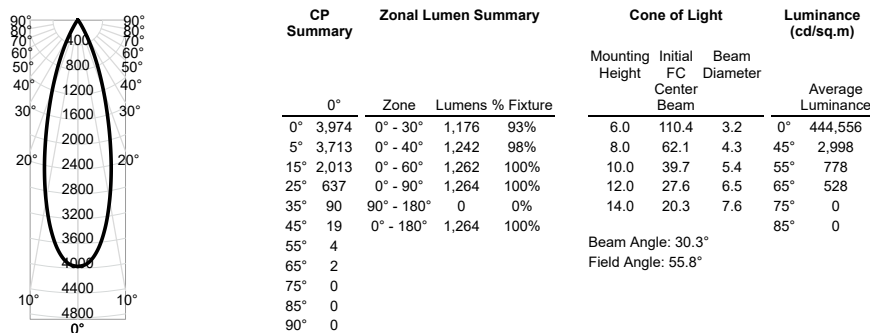

ICO4ADJ 35/15 AR T00 LSS 45D at 0DEG Input Watts: 15.1, Delivered Lumens: 1244, LPW: 82.4, S/MH: 0.79, Test No: ISF 20509P101

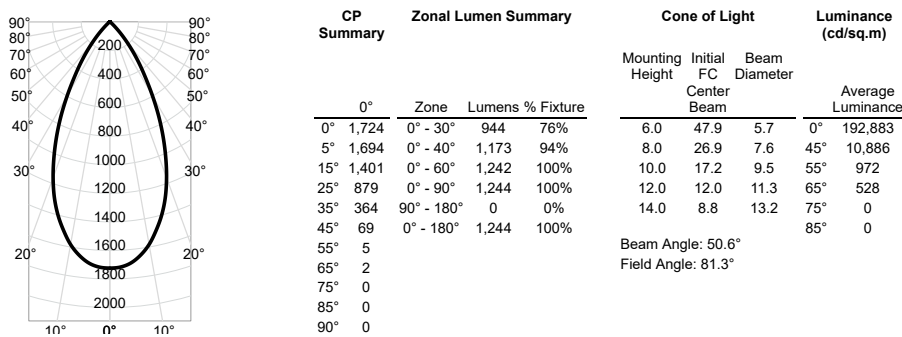

ICO4ADJ 35/15 AR T00 LSS 50D at 0DEG Input Watts: 15.1, Delivered Lumens: 1132, LPW: 75.0, S/MH: 0.84, Test No: ISF 193862P101

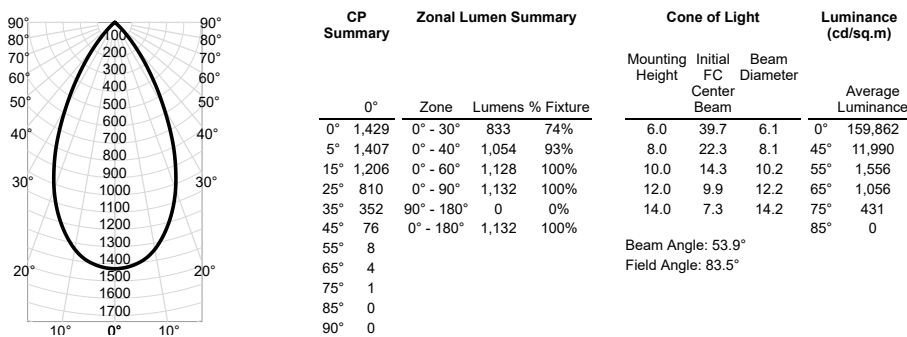

nLight® AIR is the ideal solution for retrofit or new construction spaces where adding communication wiring is cost prohibitive. The integrated nLight AIR rPP20 Power Pack is part of each EVO Luminaire ordered with the NLTAIR option. These individually addressable controls offer the ultimate in flexibility during initial setup and for space repurposing.

nLight® AIR Control Accessories

Order as separate catalog number. Visit [nLight AIR](#).

Wall Switches	Model Number
On/Off single pole	rPODB (color) G2
On/Off two pole	rPODB 2P (color) G2
On/Off & raise/lower single pole	rPODB DX (color) G2
On/Off & raise/lower two pole	rPODB 2P DX (color) G2

nLight® AIR Control Accessories (cont.)

Occupancy Sensors (PIR/dual tech)	Model Number
Small motion 360°, ceiling	rCMS 9 / rCMS PDT 9
Large motion 360°, ceiling	rCMS 10 / rCMS PDT 10

Possibilities for nLight® AIR

Fixtures ordered *without* the NLTAIR option

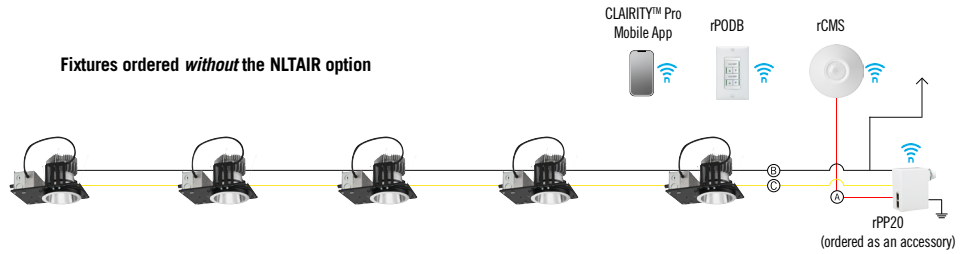

Fixtures ordered *with* the NLTAIR option

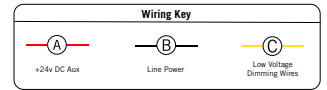
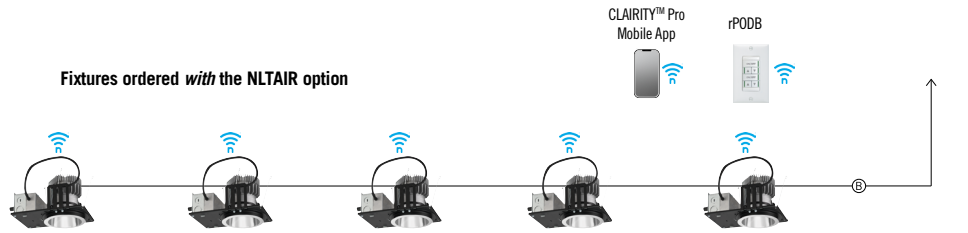

nLight® Wired The nLight® solution is a digital networked lighting control system that provides both energy savings and increased user configurability by cost effectively integrating time-based, daylight-based, sensor-based and manual lighting control schemes.

nLight® Wired Control Accessories

Order as separate catalog number. Visit [nLight](#).

Wall Switches	Model Number
On/Off single pole	nPODM (XX)
On/Off two pole	nPODM 2P (XX)
On/Off & raise/lower single pole	nPOD DX (XX)
On/Off & raise/lower two pole	nPODM 2P DX (XX)
Graphic touchscreen	nPOD GFX (XX)

Photocell Controls	Model Number
Dimming	nCM ADCX

nLight® Wired Control Accessories (cont.)

Occupancy Sensors (PIR/dual tech)	Model Number
Small motion 360°, ceiling	nCM 9 / nCM PDT 9
Large motion 360°, ceiling	nCM 10 / nCM PDT 10
Wide View	nWV 16 / nWV PDT 16
Wall switch with raise/lower	nWSX LV DX / nWSX PDT LV DX

Cat-5 Cables (plenum rated)	Model Number
10', CAT5	CAT5 10FT J1
15', CAT5	CAT5 15FT J1

Possibilities for nLight® wired

Fixtures ordered *without* the NLT option

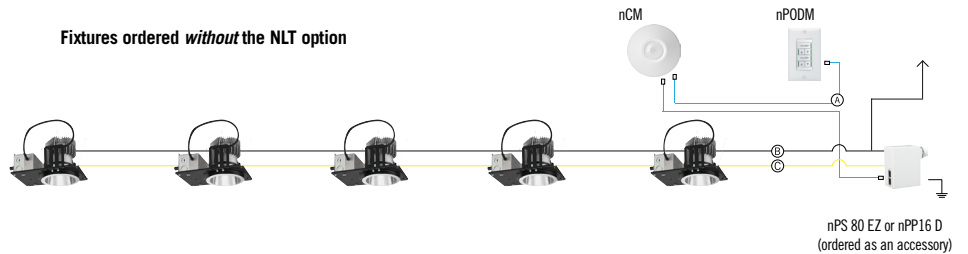

Fixtures ordered *with* the NLT option

