



LIS Series

With Optional Replaceable Light Engine

Current's Lumination LED fixtures with TriGain® technology **LIS Suspended** Series are designed to offer lighting designers enhanced CRI and R9 without sacrificing efficiency. With R9 greater than 50, these fixtures display objects like produce, fabric, skin-tones and artwork. Available in 7% and 12% uplight versions as well.

CONSTRUCTION

Heatsink: Fully Recyclable Heatsink

Paint: White

Weight: <20lb (9.07kg)

OPTICAL SYSTEM

Lumens: 4,200 - 22,000

Distribution: 100% Direct, 12% Uplight, 7% Uplight

Wattage: 29 - 185W

Efficacy: Up to 144 LPW

CCT: 3500K & 4000K

CRI: 90 TriGain®

ELECTRICAL

Input Voltage: 120–277V, 347V

Input Frequency: 50/60Hz

Power Factor (PF)*: >90%*

Total Harmonic Distortion (THD)*: <20%**

Transient Protection: 100 kHz ring wave, 2.5 kV level

LED Driver Type: Class 2, Replaceable, High Efficiency LED Driver rated for 50,000 hours
(When used within operating conditions.)

Audible Noise: Per 29CFR 1910 sub part G: <24 dba (1 foot)

**Output Frequency/
Flicker Rate:** NEMA 77

*except for the following condition:
• 4ft SKU with [EL] option

** PF and THD may vary with options

CONTROLS

Dimming: Standard, 0–10V Universal, 1%

Sensors: Daintree® EZ Connect, Daintree® One, & Daintree® Networked available w/ Integrated Sensor

Controls: High-end trim available

DLC 5.1 LLLC: Integrated/embedded networked lighting control, luminaire-level lighting control (LLC)

LUMEN MAINTENANCE

L70 @ 100,000 hours

L70

LUMEN AMBIENT TEMPERATURE

TYPE	TEMPERATURE RATE
OPERATING TEMPERATURE*	-10°C to 35°C
STORAGE TEMPERATURE	-40°C to +70°C

*Emergency Battery derates the Operating Temperature to 0°C.

MOUNTING & ADDITIONAL FEATURES

- **Mounting Options:** Ceiling, Surface, Suspended
- **Removable Light Engine:** Available
- **Continuous Runs:** Up to 400' on a single power drop
- **Quick-Connect Design:** Eliminates snaking for straight lines and helps cut installation time.
- **Optional Uplight Distribution:** Available with two uplight configurations to reduce shadowing and dark ceilings.
- **Optional Emergency Battery:** Bodine BSL310 battery back-up system

DESIGN LIFE & WARRANTY

- **Rated Life:**
 - L70 @ 90,000 hours for Trigain® only
 - L85 @ 75,000 hours
- **High Temperature High Humidity:** 60°C / 90% (non-condensing)
- **Safety:** UL/cUL Listed
- **Ratings:** IP20, IK02
- **Electronic Vibration Testing:** Multi Axis, Random Vibration Profile: 2-2000 Hz, 5Gs on electronics
- **Current's Limited 5-year Warranty:** Please refer to [IND599](#) in Product Downloads section



Please refer to DLC QPL website for the latest and most complete information www.designlights.org/QP

Ordering Information

LIS3

T

CS

FAMILY	INSTALL TYPE	FIXTURE TYPE	VOLTAGE	NOMINAL LUMEN	DISTRIBUTION	CRI	CCT	CONTROLS	MOUNTING	FINISH	OPTIONS
LIS3 = Indirect Suspended	C² = Continuous I = Independent	4F = 4 ft Fixed Light Engine 4R = 4 ft Removable Light Engine 8F = 8 ft Fixed Light Engine 8R¹¹ = 8 ft Removable Light Engine	0 = 120–277 VAC D = 347 VAC	4 ft Only 42 = 4200 52 = 5200 62 = 6250 85⁸ = 8500 A1⁸ = 11000 8 ft Only 84 = 8400 A0 = 10400 A2 = 12000 A7^{8,10} = 17000 B2^{8,10} = 22000	D1 = 100% Direct D8 = 12% Uplight D9 = 7% Uplight	T = 90CRI Trigain®	35 = 3500K 40 = 4000K	V1 = 0–10V,1% Dimming T1³ = Daintree® One w/ fixture integrated sensor, factory programmed preset TT³ = Daintree® EZ Connect Wireless w/fixture integrated sensor TZ³ = Daintree® Networked Wireless w/ fixture integrated sensor TQ³ = Daintree® Networked Wireless Enabled	CS = (See accessories page below for further accessory/ mounting options which have to be ordered separately) <i>2 mounting brackets come included with each fixture.</i>	WHITE = White BASE = White heatsink, Galvanized metal power supply enclosure & bracket BLCK⁹ = Black heatsink, power supply enclosure & bracket	Blank = No Options BC¹ = Branch Circuit EL^{4,5} = Emergency Light 1PK = Single Pack P10^{6,7} = 10 ft (14 AWG 5 cond) Power Cord White P20^{6,7} = 20 ft (14 AWG 5 cond) Power Cord White

ORDERING NOTES:

- BC option not available for '14' & '18' fixture type.
- Starter kit required (see accessory page below).
- Not available with 347V or EL option. 11" Mounting height limitation.
- EL option not available with 347V.
- EL option available with V1 Controls only.
- Only 1 cord option (P10 or P20) per SKU.
- Cord options (P10, P20) not available with: EL or BC options, 347V input voltage, continuous fixture type.
- Not available with 347V or EL option
- BLCK finish not available with T1, TT, and TZ controls
- Not available with 8R fixture type.
- Not available with [A7] and [B2] lumen codes.

PERFORMANCE TABLES

TRIGAIN®, CRI 90+					
DIMENSIONS	OPTICAL CODE	CCT	LUMENS	POWER	LPW
4 ft	42T35	3500	3990	29	137.6
	42T40	4000	4200	29	144.8
	52T35	3500	4940	37	133.5
	52T40	4000	5200	37	140.5
	62T35	3500	5940	45	132.0
	62T40	4000	6250	45	138.9
	85T35	3500	8500	66	128.8
	85T40	4000	8930	66	135.3
	A1T35	3500	11375	92	123.6
A1T40	4000	11945	92	129.8	
8 ft	84T35	3500	8028	59	136.1
	84T40	4000	8450	59	143.2
	A0T35	3500	9975	76	131.3
	A0T40	4000	10500	76	138.2
	A2T35	3500	11355	91	124.8
	A2T40	4000	11950	91	131.3
	A7T35	3500	17095	131	130.5
	A7T40	4000	17950	131	137.0
	B2T35	3500	17950	184	121.7
B2T40	4000	23505	184	127.7	

- NOTE:**
- 5 Watt increment for 347V
 - 4 Watt increment for EL option
 - 2 Watt increment for T1, TT, TZ option

FACTORY INSTALLED STARTER KIT

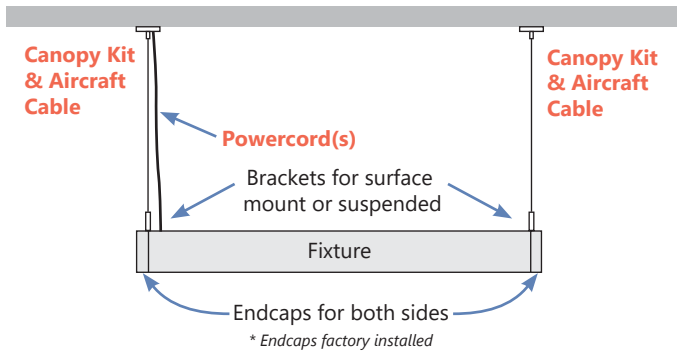

RED indicates items that must be ordered as options or accessories.

FIELD INSTALLED IS ONE STARTER KIT PER RUN, ORDERED SEPARATELY.

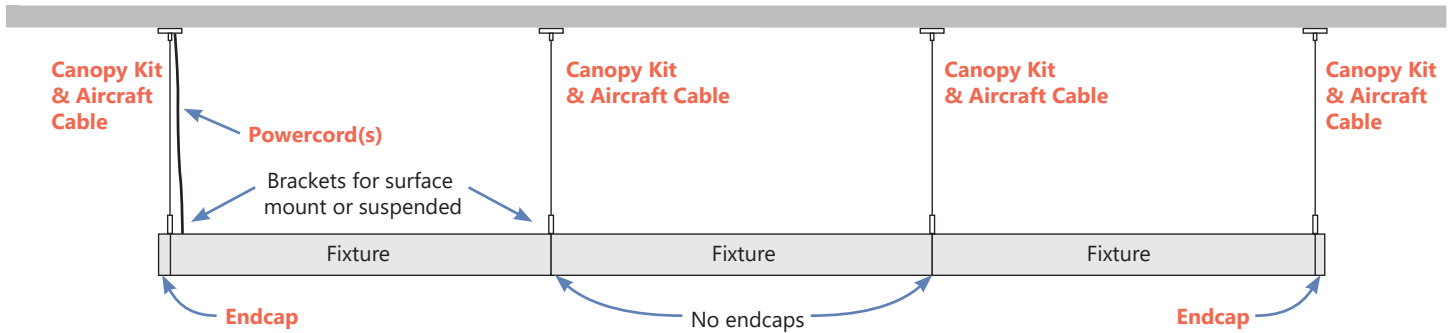

RED indicates items that must be ordered as options or accessories.
 The starter, when suspended, is normally the only fixture in the row with (2) suspension hangers.
 The rest of the run may be suspended from a single hanger.

CUSTOMER NAME

Project Name _____

Date _____ Type _____

Catalog Number _____

PRODUCT DIMENSIONS

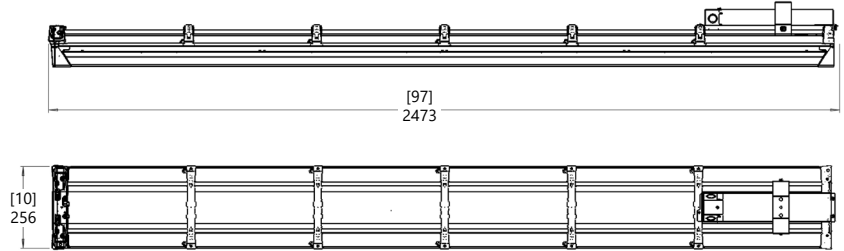
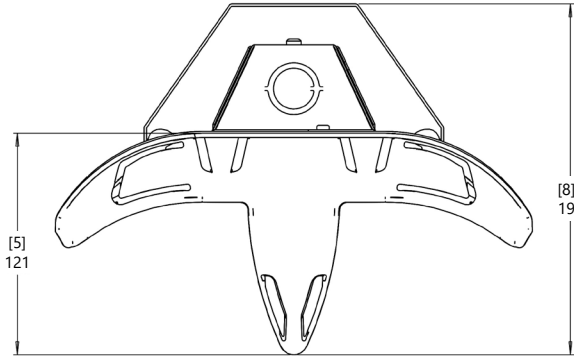

CONFIGURATION INDEPENDENT	4 FT	8 FT
Length "L" (Inches)	49	97
Length "L" (MM)	1256	2473
Length "L" w/SENSOR (Inches)	56	104
Length "L" w/SENSOR (MM)	1432	2643





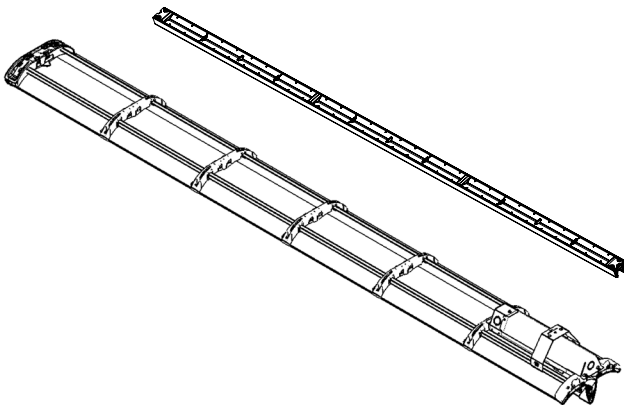

*Continuous fixtures are exactly 48" and 96" long

LIS REPLACEABLE LIGHT ENGINE



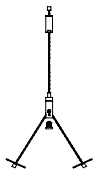
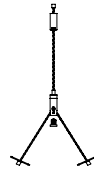

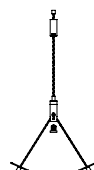
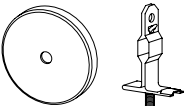
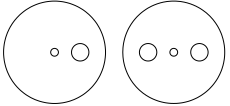
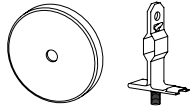
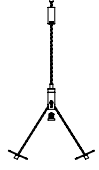

MAXIMUM RUN LENGTH PER 1 POWER DROP				
Supply Voltage	8FT LUMEN CODE			
	[84]	[A0] [A2]	[A7]	[B4]
120V	192'	160'	80'	60'
277V or 347V	400'	320'	188'	132'

ACCESSORIES

MOUNTING/ACCESSORY OPTIONS		PRODUCT CODE
SAMPLE SKU: LISI4B042D1P40VQCSWHTESPL		93073490
<p>POWER CORD KIT Options</p> <p>Comes with:</p> <ul style="list-style-type: none"> • 1x Power Feed Cable • 1x Strain Relief 	 <p>Power Feed Cable (4 cond; includes black, white, green and red (for additional circuit))</p>  <p>Dimming Feed Cable (2 cond; includes purple and gray)</p> <p><small>**Power and Dimming Feed Cables are #14 gauge 600V rated</small></p>	<p>10 FT KIT 93083221: BLK 93083222: WHT</p> <p>20 FT KIT 93083223: BLK 93083224: WHT</p>
<p>SUSPENDED KITS Mounting Open/Unfinished Ceiling</p> <p>Comes with:</p> <ul style="list-style-type: none"> • 2x Aircraft Cables • 1x Strain Relief 	 <p>Mounting Cables</p>	<p>10 FT KIT 93035285: 10' Kit</p> <p>20 FT KIT 93116031: 20' Kit</p>
<p>SUSPENDED KITS Mounting + Power Open /Unfinished Ceiling</p> <p>Comes with:</p> <ul style="list-style-type: none"> • 2x Aircraft Cables • 1x Power Feed Cable 	 <p>Mounting Cables</p>  <p>Power Feed Cable (4 cond; includes black, white, green and red (for additional circuit))</p>  <p>Dimming Feed Cable (2 cond; includes purple and gray)</p> <p><small>**Power and Dimming Feed Cables are #14 gauge 600V rated</small></p>	<p>10 FT KIT 93122346: WHT with Dimming 93122348: BLK with Dimming 93115897: WHT No Dimming 93115899: BLK No Dimming</p> <p>20 FT KIT 93122347: WHT with Dimming 93122349: BLK with Dimming 93115898: WHT No Dimming 93115900: BLK No Dimming</p>
<p>SUSPENDED KITS Mounting + Power Open /Unfinished Ceiling</p> <p>Comes with:</p> <ul style="list-style-type: none"> • 2x Aircraft Cables • 2x Upper Mounting Kit <ul style="list-style-type: none"> ◦ 2" canopy Cover ◦ T-Bar Clips 	 <p>Mounting Cables</p>  <p>Upper Mounting Kit</p>	<p>10 FT KIT 93115708: WHT Canopy 93115710: BLK Canopy</p> <p>20 FT KIT 93115709: WHT Canopy 93115711: BLK Canopy</p>
<p>SUSPENDED KITS Mounting + Power Finished Ceiling</p> <p>Comes with:</p> <ul style="list-style-type: none"> • 2x Aircraft Cables • 1x Power Feed Cable • 1x Canopy Kit <ul style="list-style-type: none"> ◦ 2 Cord Power Drop Canopy Cover ◦ 1 Cord Power Drop Canopy Cover ◦ Canopy Cover Strain relief (2x) ◦ Canopy Cover Hardware kit • 2x Upper Mounting Kit <ul style="list-style-type: none"> ◦ 2" canopy Cover ◦ T-Bar Clips 	 <p>Canopy Kit</p>  <p>Upper Mounting Kit</p>  <p>Mounting Cables</p>  <p>Power Feed Cable (4 cond; includes black, white, green and red (for additional circuit))</p>  <p>Dimming Feed Cable (2 cond; includes purple and gray)</p> <p><small>**Power and Dimming Feed Cables are #14 gauge 600V rated</small></p>	<p>10 FT KIT 93122350: WHT with Dimming 93122352: BLK with Dimming 93115847: WHT No Dimming 93115849: BLK No Dimming</p> <p>20 FT KIT 93122351: WHT with Dimming 93122353: BLK with Dimming 93115848: WHT No Dimming 93115850: BLK No Dimming</p>

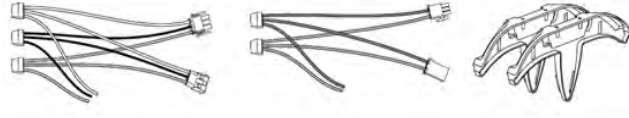
ADDITIONAL ACCESSORIES

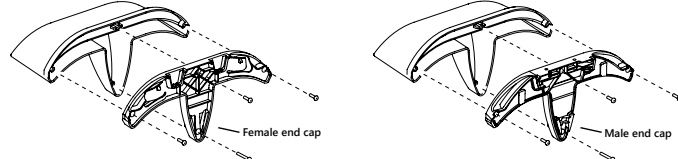
MOUNTING/ACCESSORY OPTIONS		PRODUCT CODE
<p>SUSPENDED KITS Direct Mounting Open/Unfinished Ceiling Comes with: • 2x T-Grip Clips + bolts</p>	 <p>T-Grid Clip + Bolt</p>	<p>T-GRID CLIP + BOLT 93126294</p>
<p>Starter Kit (1 row) Comes with: • 1x Starter Harness • 2x Endcaps</p>	 <p>Starter Kit Harnesses Endcaps</p>	<p>END CAPS COLORS 93018007: WHT End Caps 93081607: GRY End Caps 93081606: BLK End Caps 93081609: RED End Caps</p>
<p>Starter Kit (10 rows) Comes with: • 10x Starter Harness • 20x Endcaps</p>	 <p>Starter Kit Harnesses Endcaps</p>	<p>END CAPS COLORS 93022791: WHT End Caps 93081608: GRY End Caps 93081245: BLK End Caps 93081610: RED End Caps</p>
<p>Anti-Snaking Brackets <i>Use if extra brackets are required. See diagram on next page—brackets included with each fixture</i> Comes with: • 10x Suspension Brackets</p>	<p>Standard Suspension Bracket Anti-Snaking Suspension Bracket</p> 	<p>94210: Standard Suspension Brackets 93088000: Anti-Snaking Suspension Brackets</p>
<p>Architectural End Cap</p>	 <p>Female end cap Male end cap</p>	<p>93039940: Contains set (2)</p>

SENSOR COVERAGE PATTERN

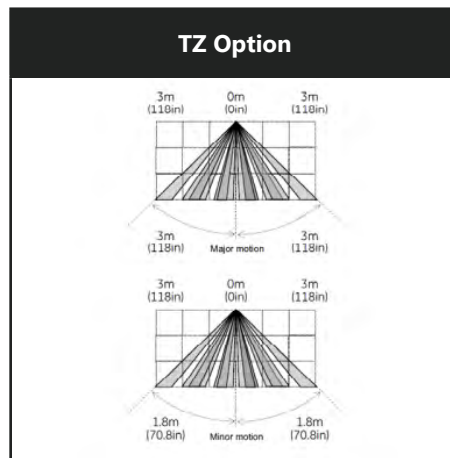
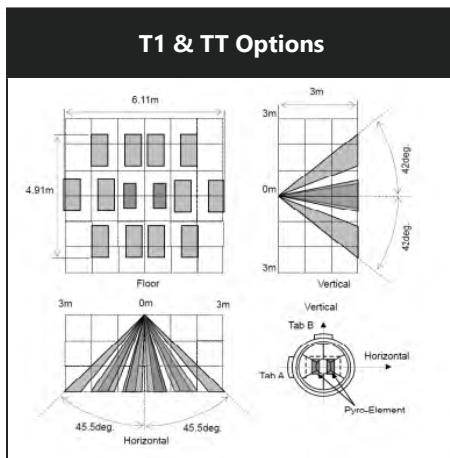

CUSTOMER NAME

Project Name _____

Date _____ Type _____

Catalog Number _____

EMERGENCY BATTERY OPTION

- Luminaires with the "EL" option code come equipped with a Bodine BSL310 battery back-up system to provide lighting during power interruptions.
- To calculate delivered lumens for an EL equipped luminaire use the following formula:
Emergency Mode Lumens = P x LPW
"P" is the output power of the emergency system (10W for "EL")
"LPW" is the efficacy of the system as determined from the performance data

- For more information refer to:
<https://www.signify.com/en-us/brands/bodine/products/led-emergency-drivers/bsl310>
- For more information and access to all of our resources, including our design tool visit:
products.gecurrent.com

INSTALLATION

- When ordering Lumination LIS Series LED Luminaires 2 mounting brackets are included with each fixture.
- Additional mounting brackets can be ordered if needed, depending upon mounting and spacing of application.