

FEATURES & SPECIFICATIONS

INTENDED USE — Typical applications include corridors, lobbies, conference rooms and private offices.

CONSTRUCTION — Durable square metal reflectors retained by torsion springs.

Galvanized steel mounting/plaster frame; galvanized steel junction box with bottom-hinged access covers and spring latches.

Vertically adjustable mounting brackets with commercial bar hangers provide 3-3/4" total adjustment.

Two combination 1/2"-3/4" and four 1/2" knockouts for straight-through conduit runs. Capacity: 8 (4 in, 4 out). No. 12 AWG conductors, rated for 90°C.

Accommodates 12"-24" joist spacing.

Passive cooling thermal management for 25°C standard; high ambient (40°C) option available. Light engine and drivers are accessible from above or below ceiling.

Max ceiling thickness 1-1/2".

OPTICS — LEDs are binned to a 3-step MacAdam Ellipse; 80 CRI minimum. 90 CRI optional.

LED light source concealed with diffusing optical lens.

General illumination lighting with 1.0 S/MH and 55° cutoff to source and source image.

Self-flanged anodized reflectors in specular, semi-specular, or matte diffuse finishes. Also available in white and black painted reflectors.

Self-flanged anodized reflectors in specular, semi-specular, or matte diffuse finishes.

UGR — UGR is zero for fixtures aimed at nadir with a cut-off equal to or less than 60deg, per CIE 117-1996 Discomfort Glare in Interior Lighting.

ELECTRICAL — Multi-volt (120-277V, 50/60Hz) 0-10V dimming drivers mounted to junction box, 10% or 1% minimum dimming level available.

0-10V dimming fixture requires two (2) additional low-voltage wires to be pulled.

LUMEN MAINTENANCE — 70% lumen maintenance at 60,000 hours. (L70/60,000 hours)

LISTINGS — Certified to US and Canadian safety standards. Wet location standard (covered ceiling). IP55 rated. Drivers are RoHS compliant.

GOVERNMENT PROCUREMENT — BAA – Product with the BAA option qualifies as a domestic end product under the Buy American Act as implemented in the FAR and DFARS. Product with the BAA option also qualifies as manufactured in the United States under DOT Buy America regulations.

BABA – Build America Buy America: Product with the BAA option also qualifies as produced in the United States under the definitions of the Build America, Buy America Act.

Please refer to www.acuitybrands.com/buy-american for additional information.

WARRANTY — 5-year limited warranty. This is the only warranty provided and no other statements in this specification sheet create any warranty of any kind. All other express and implied warranties are disclaimed.

Complete warranty terms located at: www.acuitybrands.com/support/warranty/terms-and-conditions

Note: Actual performance may differ as a result of end-user environment and application.

All values are design or typical values, measured under laboratory conditions at 25 °C.

Specifications subject to change without notice.

PERFORMANCE DATA

LDN6SQ 3500K AR LSS 80CRI			
Nominal Lumens	Lumens	Wattage	Lm/W
500	498	5.8	85.4
750	715	8.9	80.2
1000	896	10.4	85.8
1500	1428	17.5	81.5
2000	1892	22.5	84.0
2500	2362	28.3	83.6
3000	2850	34.8	82.0
4000	3781	44.3	85.4
5000	4694	57.7	81.4

Notes

- Tested in accordance with IESNA LM-79-08.
- Tested to current IES and NEMA standards under stabilized laboratory conditions.
- CRI: 80 typical.



Catalog Number
Notes
Type

LDN6SQ STATIC WHITE

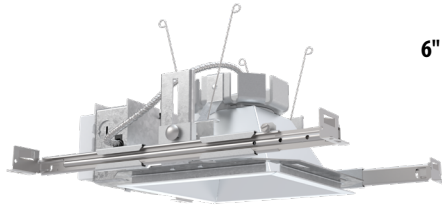

**6" Square Open and Wallwash LED
Non-IC
New Construction Downlight**

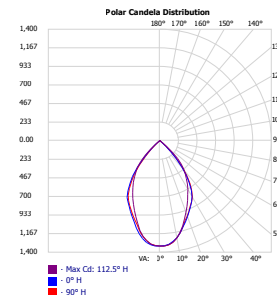

Open

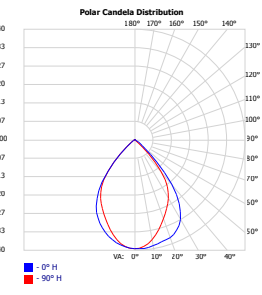

Wallwash

DIMENSIONS

LDN6SQ 500 - 1500 LUMENS

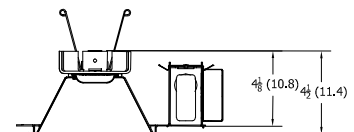
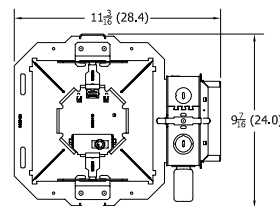

Aperture: 6-1/4 (15.9)
Ceiling Opening: 7-1/8 (18.1)
Overlap Trim: 7-1/2 (19.1)

See page 4 for other fixture dimensions

ORDERING INFORMATION

Lead times will vary depending on options selected. Consult with your sales representative.

Example: LDN6SQ 35/15 LS6 AR LSS MVOLT EZ1

LDN6SQ Series	Color temperature	Lumens ‡	Trim Style	Trim Color	Trim Finish	Flange Color ‡	Voltage
LDN6SQ 6" square	27/ 2700K	05 500 lumens	LS6 Downlight	AR	LSS Semi-specular	TRW White painted flange	MVOLT Multi-volt
	30/ 3000K	07 750 lumens	LSW6 Wallwash	WR ‡ White	LD Matte diffuse	TRBL Black painted flange	120 120V
	35/ 3500K	10 1000 lumens		BR ‡ Black	LS Specular	FCPC Custom painted flange only	277 277V
	40/ 4000K	15 1500 lumens		TCPC ‡ Custom painted trim		FRALTB D RAL painted flange only	347 ‡ 347V
	50/ 5000K	20 2000 lumens					
		25 2500 lumens					
		30 3000 lumens					
		40 4000 lumens					
		50 5000 lumens					

Driver	Emergency ‡	Control Input ‡	Options
GZ10 0-10V driver dims to 10%	(blank) No Emergency Needed	(blank) No Control Input Needed	HAO ‡ High ambient option (40°C)
GZ1 0-10V driver dims to 1%	EL Battery pack (10W constant power), non-T20 compliant, integral test switch	JOT Wireless room control with "Just One Touch" pairing	CP ‡ Chicago Plenum
D10 Minimum dimming 10% driver for use with JOT	ELR Battery pack (10W constant power), non-T20 compliant, remote test switch	NPP16D nLight® network power/relay pack with 0-10V dimming for non-eldoLED drivers (GZ10, GZ1).	RRL___ RELOC®-ready luminaire connectors enable a simple and consistent factory installed option across all ABL luminaire brands. Refer to RRL for complete nomenclature. Available only in RRLA, RRLB, RRLAE, and RRLC12S.
D1 Minimum dimming 1% driver for use with JOT	ELSD Self-diagnostic battery pack (10W constant power), non-T20 compliant, integral test switch	NPP16DER nLight® network power/relay pack with 0-10V dimming for non-eldoLED drivers (GZ10, GZ1). ER controls fixtures on emergency circuit.	BAA Buy America(n) Act and/or Build America Buy America Qualified
EZ1 0-10V eldoLED driver with smooth and flicker-free deep dimming performance down to 1%	ELRSD Self-diagnostic battery pack (10W constant power), non-T20 compliant, remote test switch	NPS80EZ nLight® dimming pack controls 0-10V eldoLED drivers (EZ1).	90CRI High CRI (90+)
EDAB eldoLED DALI SOLDRIIVE dim to dark	E10WCP Battery pack (10W constant power), T20 compliant, integral test switch	NPS80EZER nLight® dimming pack controls 0-10V eldoLED drivers (EZ1). ER controls fixtures on emergency circuit.	SF ‡ Single fuse
	E10WCPR Battery pack (10W constant power), T20 compliant, remote test switch	N80 nLight™ Lumen Compensation	
	E10WRSTAR Emergency battery pack, 10W with remote test switch and Iota STAR technology	NLTAIR2 nLight® Air enabled	
		NLTAIRER2 nLight® AIR Dimming Pack Wireless Controls. Controls fixtures on emergency circuit, not available with battery pack options	
		NLTAIREM2 nLight® AIR Dimming Pack Wireless Controls. UL924 Emergency Operation, via power interrupt detection. Available with battery pack options.	

‡ Option Value Ordering Restrictions

Option value	Restriction
Lumens	Overall height varies based on lumen package; refer to dimensional chart.
WR, BR	Not available with finishes.
347	Not available with emergency options.
SF	Must specify voltage 120V or 277V.
TRW, TRBL	Available with clear (AR) reflector only.
EL, ELR, ELSD, ELRSD, E10WCP, E10WCPR	12.5" of plenum depth or top access required for battery pack maintenance.
NPP16D, NPP16DER, NPS80EZ, NPS80EZER	Specify voltage. ER for use with generator supply EM power. Will require an emergency hot feed and normal hot feed. See UL 924 Sequence of Operation table.
N80	Fixture begins at 80% light level. Must be specified with NPS80EZ or NPS80EZ ER. Only available with EZ1 drivers.
NLTAIR, NLTAIR2, NLTAIRER2, NLTAIREM2	Not available with CP, NPS80EZ, NPS80EZER, NPP16D, NPP16DER or N80 options. not recommended for metal ceiling installations.
HAO	Fixture height is 6.5" for all lumen packages with HAO.
CP	Must specify voltage for 3000lm and above. 5000lm with marked spacing 24 L x 24 W x 14 H. Not available with emergency battery pack option.
JOT	Must specify D10 or D1 driver. Not available with nLight options. Not available with CP. Not recommended for metal ceiling installation. Not for use with emergency backup power systems other than battery packs.
Reloc® Options	Refer to RRL specification sheet on acuitybrands.com for further details.
RRLAE	Commercial fixtures should disconnect the TSPL before unplugging the RRL so it does not go into discharge mode."
RRLC12S	RRLC12S option is to be used with the OnePass OCU, OCS, OD, OFC and OD for 0-24V integrated single-circuit or 0-10V low voltage controls applications. Not available with integral dimming sensors.
E10WRSTAR	Not available with wet location, EC1, EC6, QDS, CP, 347V, NPS80EZ ER, NLTAIRER2, NLTAIREM2, ALO3 & ALO4 w/DALI, OR 2000-4500 lumens w/JOT. Top access installation or 17.5" plenum clearance required for roomside installation. Not available with integral test switch
TRALTB D, FRALTB D	RALTB D for pricing only. Replace with applicable RAL number and finish when ready to order. See the RAL BROCHURE for available color options.
TCPC, FCPC	CPC options for pricing only. Custom color chip needs to be sent in to your Customer Resolution specialist before order can be processed. Click HERE for more details

Emergency Battery Pack Options - Field Installable

Battery Model Number	Wattage	Runtime (Minutes)	Lumen Output* @ 120 Lumens/Watt	Other
ILB CP07 2H A	7W	120	840	Storm Shelter / 2 Hour Runtime
ILB CP10 A	10W	90	1200	
ILBLP CP10 HE SD A+	10W	90	1200	Title 20, Self Diagnostic
ILBLP CP15 HE SD A+	15W	90	1800	Title 20, Self Diagnostic
ILB CP20 HE A	20W	90	2400	Title 20
ILB CP20 HE SD A	20W	90	2400	Title 20, Self Diagnostic
ILBHI CP10 HE SD A+	10W	90	1200	347-480V AC Input, Title 20, Self Diagnostic
ILBHI CP15 HE SD A+	15W	90	1800	347-480V AC Input, Title 20, Self Diagnostic

All the above are UL Listed products that are certified for field install external/remote to the fixture.

*Minimum delivered lumen output to assist in product selection for increased fixture mounting height.

The CP10 delivered emergency illumination outperforms legacy 1400 lumen fluorescent emergency ballast.

Please contact us at techsupport@iotaengineering.com for any Emergency Battery related questions.

LDN6SQ

PHOTOMETRY

Distribution Curve Distribution Data Output Data Illuminance Data at 30" Above Floor for a Single Luminaire

LDN6SQ 35/10 LS6AR, input watts: 10.44, delivered lumens: 942.9, LM/W = 90.31, spacing criterion at 0= 0.96, test no. ISF 31035P168.

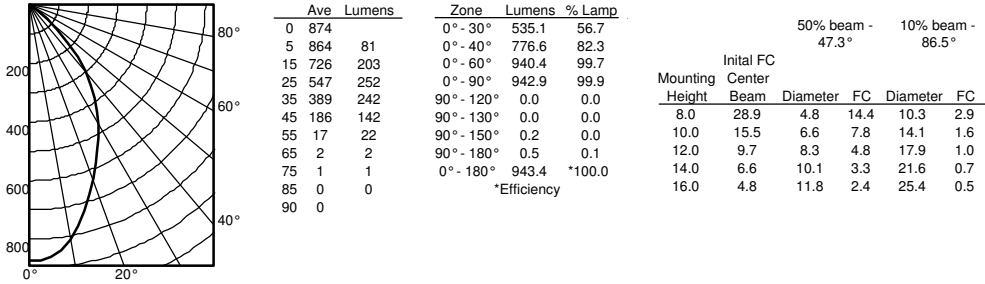

LDN6SQ 35/15 LS6AR, input watts: 17.52, delivered lumens: 1502.6, LM/W = 85.76, spacing criterion at 0= 0.96, test no. ISF 31035P171.

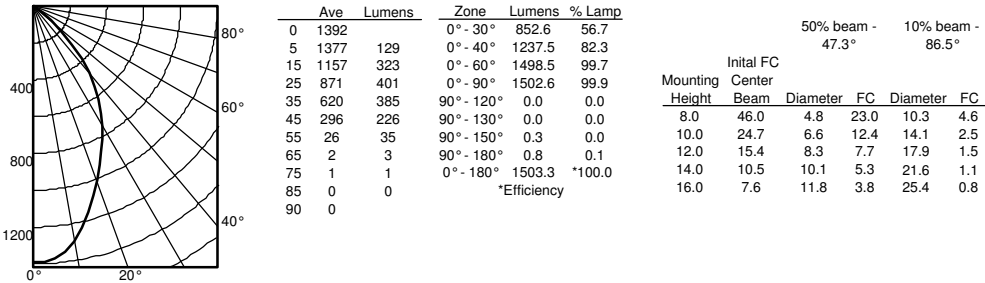

LDN6SQ 35/30 LS6AR, input watts: 34.75, delivered lumens: 2998.2, LM/W = 86.27, spacing criterion at 0= 0.96, test no. ISF 31035P180.

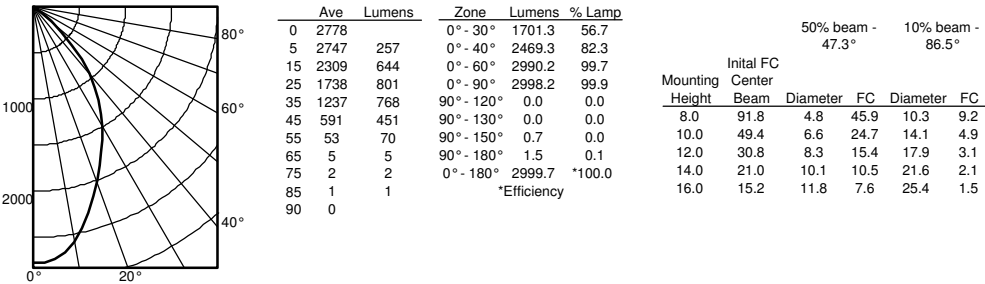

HOW TO ESTIMATE DELIVERED LUMENS IN EMERGENCY MODE

Use the formula below to estimate the delivered lumens in emergency mode

Delivered Lumens = 1.25 x P x LPW

P = Output power of emergency driver. P = 10W for PS1055CP

LPW = Lumen per watt rating of the luminaire. This information is available on the ABL luminaire spec sheet.

The LPW rating is also available at Designlight Consortium.

Notes

- Tested in accordance with IESNA LM-79-08.
- Tested to current IES and NEMA standards under stabilized laboratory conditions.
- CRI: 80 typical.

LUMEN OUTPUT MULTIPLIERS - FINISH

	Clear (AR)	White (WR)	Black (BR)
Specular (LS)	1.0	N/A	N/A
Semi-specular (LSS)	0.950	N/A	N/A
Matte diffuse (LD)	0.85	N/A	N/A
Painted	N/A	0.87	0.73

LUMEN OUTPUT MULTIPLIERS - CCT

	2700K	3000K	3500K	4000K	5000K
80CRI	0.950	0.966	1.000	1.025	1.101

LUMEN OUTPUT MULTIPLIERS - CRI

80	1.0
90	0.874

LDN6SQ

* All dimensions are inches (centimeters) unless otherwise noted.

LDN6SQ 500 - 1500 LUMENS

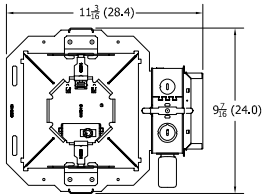

Aperture: 6-1/4 (15.9)
Ceiling Opening: 7-1/8 (18.1)
Overlap Trim: 7-1/2 (19.1)

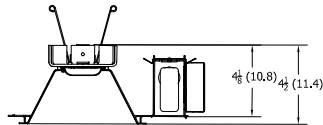

LDN6SQ 2000 - 3000 LUMENS

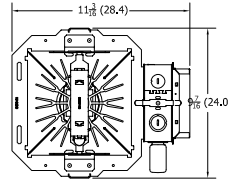

Aperture: 6-1/4 (15.9)
Ceiling Opening: 7-1/8 (18.1)
Overlap Trim: 7-1/2 (19.1)

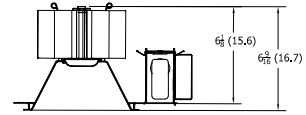

LDN6SQ 4000 - 5000 LUMENS

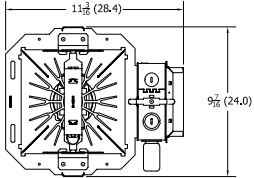

Marked Spacing: 24 x 24 x 10
Aperture: 6-1/4 (15.9)
Ceiling Opening: 7-1/8 (18.1)
Overlap Trim: 7-1/2 (19.1)

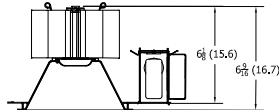

LDN6 CP

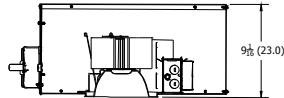
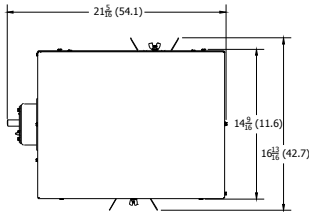

LDN6 EL

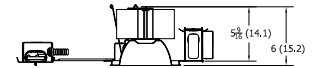
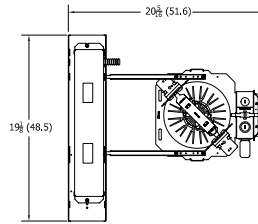

Marked Spacing over 3000 Lumens: 24 x 24 x 10
Aperture: 6-1/4 (15.9)
Ceiling Opening: 7-1/8 (18.1)
Overlap Trim: 7-1/2 (19.1)

ADDITIONAL DATA



The Sensor Switch JOT enabled solution offers a wireless, app-free approach to single room lighting control. JOT enabled products use Bluetooth® Low Energy (BLE) technology to enable wireless dimming and switching.

Diagram

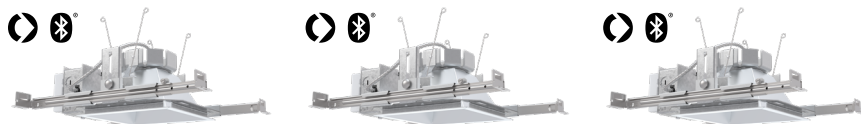

LDN6SQ Series



Sensor Switch
WSXA JOT

1. **Power:** Install JOT enabled fixtures and controls as instructed.
2. **Pair:** Insert the pairing tool into the pinhole on the wall switch; press and hold any button for 6 seconds.
3. **Play:** Once paired, each fixture will individually dim down to 10% brightness. All products will be fully functional.

COMPATIBLE 0-10V WALL-MOUNT DIMMERS

MANUFACTURER	PART NO.	POWER BOOSTER AVAILABLE
Lutron®	Diva® DDTV	
	Diva® DVSCTV	
	Nova T® NTFTV	
	Nova® NFTV	
Leviton®	AWSMT-7DW	CN100
	AWSMG-7DW	PE300
	AMRMG-7DW	
	Leviton Centura Fluorescent Control System	
	IllumaTech® IP7 Series	
Synergy®	ISD BC	RDMFC
	SLD LPCS	
	Digital Equinox (DEQ BC)	
Douglas Lighting Controls	WPC-5721	
Entertainment Technology	Tap Glide TG600FAM120 (120V)	
	Tap Glide Heatsink TGH1500FAM120 (120V)	
	Oasis OA2000FAMU	
Honeywell	EL7315A1019	EL7305A1010 (optional)
	EL7315A1009	
HUNT Dimming	Preset slide: PS-010-IV and PS-010-WH	
	Preset slide: PS-010-3W-IV and PS-010-3W-WH	
	Preset slide, controls FD-010: PS-IFC-010-IV and PS-IFC-010-WH-120/277V	
	Preset slide, controls FD-010: PS-IFC-010-3W-IV and PS-IFC-010-3W-WH-120/277V	
	Remote mounted unit: FD-010	
Lehigh Electronic Products	Solitaire	PBX
PDM Electrical Products	WPC-5721	
Starfield Controls	TR61 with DALI interface port	RT03 DALInet Router
WattStopper®	LS-4 used with LCD-101 and LCD-103	

LDN6SQ

EXAMPLE

Group Fixture Control*

*Application diagram applies for fixtures with eldoLED drivers only.

nPS 80 EZ Dimming/Control Pack (qty: 2 required)

nPODM 2P DX Dual On/Off/Dim Push-Button WallPod

nCM ADCX Daylight Sensor with Automatic Dimming Control

nCM PDT 9 Dual Technology Occupancy Sensor

Description: This design provides a dual on/off/dim wall station that enables manual control of the fixtures in Row A and Row B separately. Additionally, a daylight harvesting sensor is provided so the lights in Row B can be configured to dim automatically when daylight is available. An occupancy sensor turns off all lights when the space is vacant.

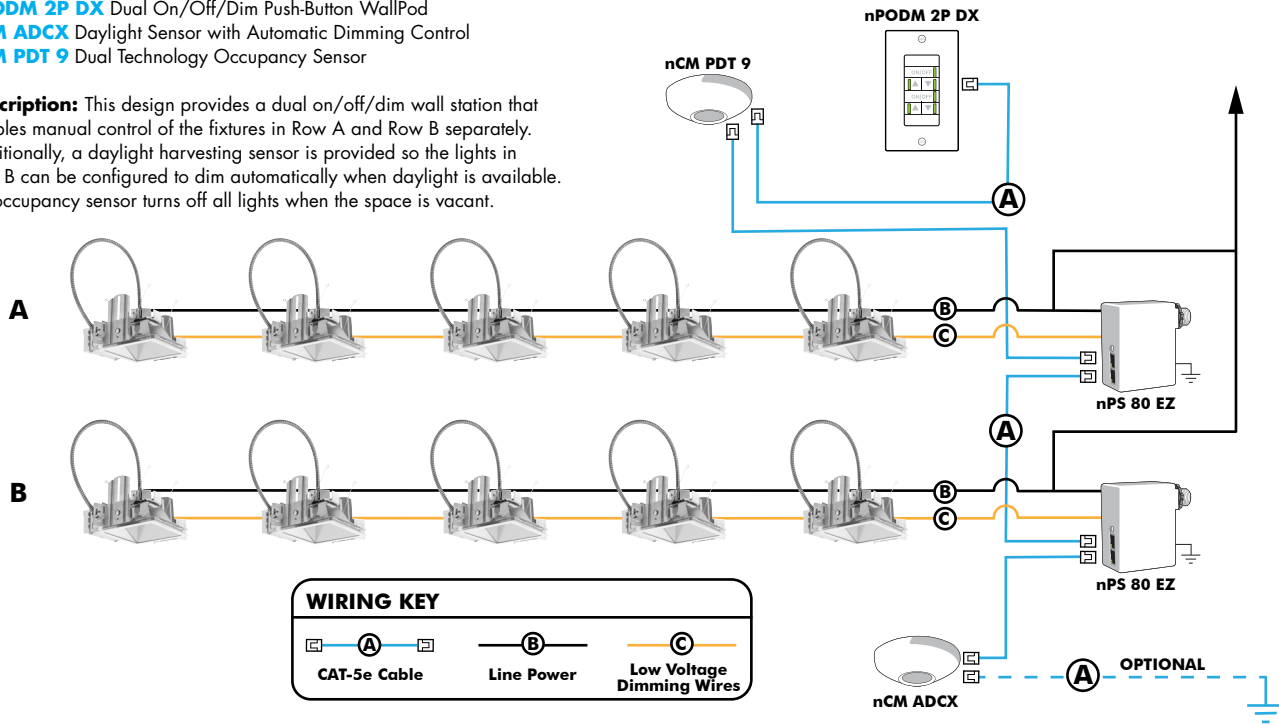

Choose Wall Controls

nLight offers multiple styles of wall controls - each with varying features and user experience.



Push-Button Wallpod
Traditional tactile buttons and LED user feedback



Graphic Wallpod
Full color touch screen provides a sophisticated look and feel

nLight® Wired Controls Accessories:

Order as separate catalog number. Visit www.acuitybrands.com/products/controls/nlight for complete listing of nLight controls.

WallPod Stations	Model number	Occupancy sensors	Model Number
On/Off	nPODM (Color)	Small motion 360°, ceiling (PIR/dual Tech)	nCM 9 / nCM PDT 9
On/Off & Raise/Lower	nPOD DX (Color)	Large motion 360°, ceiling (PIR/dual tech)	nCM 10 / nCM PDT 10
Graphic Touchscreen	nPOD GFX (Color)	Wide View (PIR/dual tech)	nWV 16 / nWV PDT 16
Photocell controls	Model Number	Wall Switch w/ Raise/Lower (PIR/dual tech)	nWSX LV DX / nWSX PDT LV DX
Dimming	nCM ADCX	Cat-5 cables (plenum rated)	Model Number
		10', CAT5 10FT	CAT5 10FT J1
		15', CAT5 15FT	CAT5 15FT J1

nLight® AIR Control Accessories:

Order as separate catalog number. Visit www.acuitybrands.com/products/controls/nlightair.

Wall switches	Model number
On/Off single pole	rPODB [color]
On/Off two pole	rPODB 2P [color]
On/Off & raise/lower single pole	rPODB DX [color]
On/Off & raise/lower two pole	rPODB 2P DX [color]
On/Off & raise/lower single pole	rPODBZ DX WH ¹

Notes

- 1 Can only be ordered with the RES7Z zone control sensor version.

UL924 Sequence of Operation

The below information applies to all nLight AIR devices with an EM option.

- EM devices will remain at their high-end trim and ignore wireless lighting control commands, unless a normal-power-sensed (NPS) broadcast is received at least every 8 seconds.
- Using the CLAIRITY+ mobile app, EM devices must be associated with a group that includes a normal power sensing device to receive NPS broadcasts.
- Only non-emergency rPP20, rLSXR, rSBOR, rSDGR, and nLight AIR luminaires with version 3.4 or later firmware can provide normal power sensing for EM devices. See specification sheets for control devices and luminaires for more information on options that support normal power sensing.

nLight AIR

nLight AIR is the ideal solution for retrofit or new construction spaces where adding communication is cost prohibitive. The integrated nLight AIR rPP20 Power Pack is part of each Lithonia LDN Luminaire. These individually addressable controls offer the ultimate in flexibility during initial setup and for space repurposing.

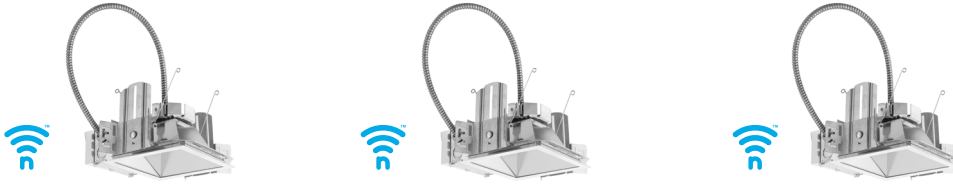

Simple as 1,2,3

1. Install the nLight® AIR fixtures with embedded smart sensor
2. Install the wireless battery-powered wall switch
3. With CLAIRITY app, pair the fixtures with the wall switch and if desired, customize the sensor settings for the desired outcome

