

# Lumination® LDS Series

## Linear Suspended



CUSTOMER NAME \_\_\_\_\_

Project Name \_\_\_\_\_

Date \_\_\_\_\_ Type \_\_\_\_\_

Catalog Number \_\_\_\_\_

The LDS series features mechanical designs which allow quick, easy and trouble-free installation of continuous rows with minimum labor for both suspended as well as surface mount applications. Multiple beam distributions and a wide range of lumen levels allow for easily optimized lighting designs for your application and make retrofitting simple. The simplicity of this design makes it seamless and yet impactful in your ceiling. Further, TriGain™ technology gives you enriched color performance with no sacrifice to efficiency. With CRI and R9 above 90 and efficacy at a remarkable 140 lumens per watt, there is no need to choose between premium light and low operating costs. The LDS series is one of the most advanced technological luminaire with the ability to connect to Daintree, and motion sensors.

### CONSTRUCTION

<b>Housing:</b>	22 gauge galvanized steel
<b>Lens:</b>	PC lens, Louvers
<b>Paint:</b>	Powder Coat White or Black, Stainless
<b>Weight:</b>	<20 lbs.

### OPTICAL SYSTEM

<b>Lumens:</b>	3,400-17,000lm
<b>Wattage:</b>	31-145W
<b>Efficacy:</b>	105-140 LPW
<b>CCT:</b>	3000K, 3500K, 4000K
<b>CRI:</b>	83, 90+ TriGain™
<b>Color Consistency:</b>	4 Step MacAdam Elipse
<b>Distribution Patterns:</b>	Direct: Wide, Narrow, Wall Wash, Uplight, Louvers

### ELECTRICAL

<b>Input Voltage:</b>	120-277V & 347V
<b>Input Frequency:</b>	50/60Hz
<b>Power Factor (PF)*:</b>	>0.9* except for the following conditions: - 4ft SKU with 347V - 4ft SKU with E2 option
<b>Total Harmonic Distortion (THD)*:</b>	<20%*

\* PF and THD may vary with options

### CONTROLS

<b>Dimming:</b>	0-10V, 10%
<b>Sensors:</b>	Daintree Wireless Enabled, Integral Sensor Optional

### LUMEN AMBIENT TEMPERATURE

TYPE	TEMPERATURE RATE
OPERATING TEMPERATURE	0° up to 35° C
STORAGE TEMPERATURE	-40°C to 60°C

### LUMEN MAINTENANCE

LXX @ Hours 60,000 HR
L85

### MOUNTING

- Suspension or Direct Mount, see accessories table

### DESIGN LIFE & WARRANTY

- Current's Limited 5-year Warranty:  
Please refer to document **IND599** for more information.

# Lumination® LDS Series

Linear Suspended

## Ordering Information

### CUSTOMER NAME

Project Name \_\_\_\_\_

Date \_\_\_\_\_ Type \_\_\_\_\_

Catalog Number \_\_\_\_\_

### Ordering Information<sup>1</sup> (Important: Please see note 1 below) :

**LDS**

**B**

**CS**

PRODUCT ID	FIXTURE TYPE	GENERATION	VOLTAGE	LUMEN	DISTRIBUTION	CRI	CCT	CONTROLS	MOUNTING	FINISH	OPTIONS
<b>LDS</b> = Direct Suspended	<b>I4</b> <sup>1</sup> = 4 Ft Independent <b>C4</b> = 4 Ft Continuous <sup>2</sup> <b>I8</b> = 8 Ft Independent <b>C8</b> = 8 Ft Continuous <sup>2</sup>	<b>B</b> = 2 <sup>nd</sup> Generation	<b>0</b> = 120-277V <b>D</b> = 347V	<b>4 Ft:</b> <b>34</b> = 3400 Lumen <b>40</b> = 4000 Lumen <b>50</b> = 5000 Lumen <b>65</b> = 6500 Lumen <sup>3</sup> <b>85</b> = 8500 Lumen <sup>3</sup>  <b>8 Ft:</b> <b>68</b> = 6800 Lumen <b>80</b> = 8000 Lumen <b>A0</b> = 10,000 Lumen <b>A3</b> = 13,000 Lumen <sup>3</sup> <b>A7</b> = 17,000 Lumen <sup>3</sup>	<b>W0</b> = Wide <b>W1</b> = Wide + Uplight <sup>4</sup> <b>N0</b> = Narrow <b>N1</b> = Narrow + Uplight <sup>4</sup> <b>WW</b> <sup>5</sup> = Wall Wash <b>L0</b> <sup>6</sup> = Louvers <b>L1</b> <sup>6</sup> = Louvers + Uplight <sup>4</sup>	<b>T</b> <sup>7</sup> = 90 with Trigain <b>8</b> = 83 CRI	<b>30</b> = 3000 CCT <sup>8</sup> <b>35</b> = 3500 CCT <b>40</b> = 4000 CCT	<b>VQ</b> = 0-10V Dimming <b>TQ</b> = Zigbee Enabled <b>TS</b> = Zigbee Enabled with Daintree WFA <b>T1</b> <sup>9</sup> = Daintree One w/ fixture integrated sensor, factory programmed preset <b>TT</b> <sup>9</sup> = Daintree EZ connect Wireless w/ fixture integrated sensor <b>TZ</b> <sup>9</sup> = Daintree Enterprise Wireless w/ fixture integrated sensor <b>S1</b> = On/Off occ sensor <sup>10</sup> , only for height > 10' <b>S2</b> = On/Off occ & daylight harvesting sensor <sup>11</sup> only for height > 10'	<b>CS</b> <sup>12</sup> = 2 Mounting Brackets	<b>WHITE</b> = White <b>BLCK</b> = Black <b>ST01</b> = Stainless Steel	<b>A</b> <sup>13</sup> = Branch Circuit <b>E2</b> <sup>14,15</sup> = Emergency Battery <b>SPL</b> <sup>16</sup> = Sample with 6' cord and 120Vac wall plug <b>R10</b> <sup>17</sup> = RELOC 277V 10' 3-Circuit <b>P10</b> <sup>18</sup> = 10' power cord, 14AWG 5-COND <b>P20</b> <sup>18</sup> = 20' power cord, 14AWG 5-COND <b>SP</b> = Single Pack

#### ORDERING NOTES:

1. I4 not available with distribution: W1, N1 and L1
2. Starter kit required (see accessory page)
3. Not available with DISTRIBUTION = W1, N1, WW, L0, L1, CRI = T
4. Uplight Distribution = 20%
5. Not available with 65, 85, A3, A7 lumen codes
6. Louver options (L0, L1) do not have a lens
7. T available only in 34, 40, 50, 68, 80, and A0 lumen options
8. 30 not available for 90CRI
9. 11' mounting height limitation, not available with 347V or E2 options
10. Not compatible with 347V
11. Order programming remote (197634) separately
12. See accessories page below for further accessory/mounting options which need to be ordered separately.
13. Branch circuit only available with C4&C8 fixture type
14. Emergency Battery only available with VQ controls and W0, N0, N1, WW, L0 distributions
15. Emergency Mode Lumens = P x LPW. "P" is the output power of the emergency system (10W for "E2")
16. SPL option is not UL listed. Only available as Independent fixture and only compatible with 120/277V input voltage.
17. R10 option available with Independent fixture and only compatible with 277Vac RELOC installation.
18. White cord for 'WHITE' and black cord for 'BLCK' or 'ST01' finishes. Independent fixtures only

# Lumination® LDS Series

Linear Suspended

**Ordering Information**

## CUSTOMER NAME

Project Name \_\_\_\_\_

Date \_\_\_\_\_ Type \_\_\_\_\_

Catalog Number \_\_\_\_\_

## 80 CRI: 3500K, NARROW DISTRIBUTION

LENGTH	LUMEN CODE	LUMEN	POWER	POWER	LPW	LPW
			120-277V (W)	347V (W)	120-277V (W)	347V (W)
4 ft	34	3400	27	29	126	116
	40	4000	32	34	127	119
	50	5000	39	42	129	119
	65	6500	52	54	125	121
	85	8250	70	73	118	113
8 ft	68	6800	53	55	128	124
	80	8000	62	64	129	124
	A0	10,000	79	81	127	123
	A3	13,000	107	110	122	118
	A7	17,000	145	151	117	113

## 90 CRI: TRIGAIN™

LENGTH	LUMEN CODE	LUMEN	POWER	LPW
			120-277V (W)	120-277V (W)
4 ft	34	3400	31	110
	40	4000	38	118
	50	5000	43.6	115
8 ft	68	6800	62	110
	80	8000	66	121
	A0	10,000	84.5	118

# Lumination® LDS Series

Linear Suspended

## Product Dimensions

### CUSTOMER NAME

Project Name \_\_\_\_\_

Date \_\_\_\_\_ Type \_\_\_\_\_

Catalog Number \_\_\_\_\_

### PRODUCT DIMENSIONS

CONFIGURATION - INDEPENDENT	4 FT	8 FT
Length "L"	50" (1270 MM)	98" (2489 MM)
Length "L" w/Sensor	57" (1448 MM)	105" (2667 MM)

NOTE: Continuous fixtures are exactly 48" and 96" long

SUPPLY VOLTAGE	MAXIMUM RUN LENGTH PER 1 POWER DROP				
	LUMEN CODE				
	[34] [68]	[40] [80]	[50] [A0]	[65] [A3]	[85] [A7]
120V	220'	180'	160'	110'	80'
277V or 347V	530'	420'	380'	290'	210'

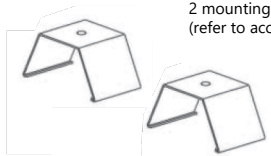
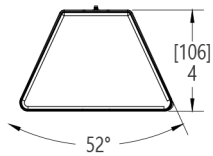
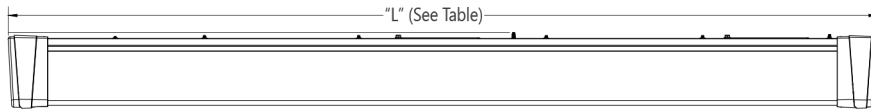

2 mounting brackets come standard with fixture  
(refer to accessories page for ordering of any other accessories required)

# Lumination® LDS Series

## Linear Suspended Accessories

### CUSTOMER NAME

Project Name \_\_\_\_\_

Date \_\_\_\_\_ Type \_\_\_\_\_

Catalog Number \_\_\_\_\_

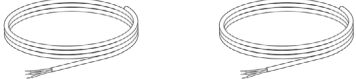
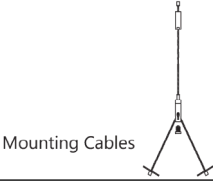
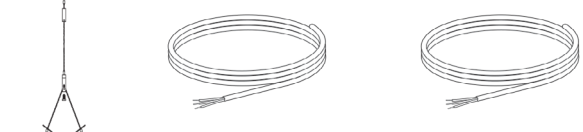
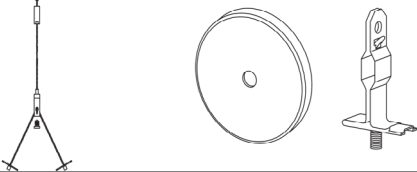
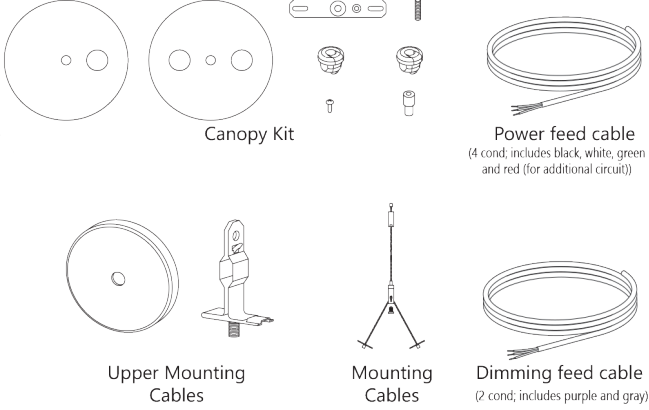
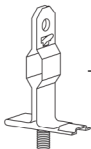
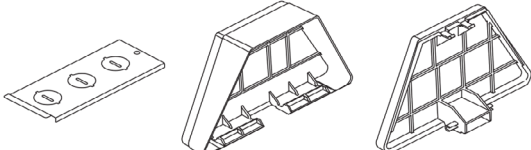
ACCESSORIES	DESCRIPTION	PRODUCT CODE
 <p>Power feed cable (4 cond, includes black, white, green and red (for additional circuit))</p> <p>Dimming feed cable (2 cond, includes purple and gray)</p> <p><small>**Power and Dimming Feed Cables are #14 gauge 600V rated</small></p>	<p><b>Power Cord Kit - Options</b>  <b>Comes with:</b>            1x Power Feed Cable            1x Strain Relief</p>	<p><b>10 Ft Kit</b>  <b>93083221:</b> BLK  <b>93083222:</b> WHT  <b>20 Ft Kit</b>  <b>93083223:</b> BLK  <b>93083224:</b> WHT</p>
 <p>Mounting Cables</p>	<p><b>Suspended Kits - Mounting Open/Unfinished Ceiling</b>  <b>Comes with:</b>            2x Aircraft Cables</p>	<p><b>10 Ft Kit</b>  <b>93035285:</b> 10' Kit  <b>20 Ft Kit</b>  <b>93116031:</b> 20' Kit</p>
 <p>Mounting Cables</p> <p>Power feed cable (4 cond, includes black, white, green and red (for additional circuit))</p> <p>Dimming feed cable (2 cond, includes purple and gray)</p> <p><small>**Power and Dimming Feed Cables are #14 gauge 600V rated</small></p>	<p><b>Suspended Kits - Mounting + Power Open/Unfinished Ceiling</b>  <b>Comes with:</b>            2x Aircraft Cables            1x Power Feed Cable</p>	<p><b>10 Ft Kit</b>  <b>93122346:</b> WHT with Dimming  <b>93122348:</b> BLK with Dimming  <b>93115897:</b> WHT No Dimming  <b>93115899:</b> BLK No Dimming  <b>20 Ft Kit</b>  <b>93122347:</b> WHT with Dimming  <b>93122349:</b> BLK with Dimming  <b>93115898:</b> WHT No Dimming  <b>93115900:</b> BLK No Dimming</p>
 <p>Mounting Cables</p> <p>Upper Mounting Kit</p> <p>T-Bar Clips</p>	<p><b>Suspended Kits - Mounting Finished Ceiling</b>  <b>Comes with:</b>            2x Aircraft Cables            2x Upper Mounting Kit            • 2" canopy Cover            • T-Bar Clips</p>	<p><b>10 Ft Kit</b>  <b>93115708:</b> WHT Canopy  <b>93115710:</b> BLK Canopy  <b>20 Ft Kit</b>  <b>93115709:</b> WHT Canopy  <b>93115711:</b> BLK Canopy</p>
 <p>Canopy Kit</p> <p>Power feed cable (4 cond, includes black, white, green and red (for additional circuit))</p> <p>Upper Mounting Cables</p> <p>Mounting Cables</p> <p>Dimming feed cable (2 cond, includes purple and gray)</p>	<p><b>Suspended Kits - Mounting + Power Suspended Kits - Mounting + Power Finished Ceiling</b>  <b>Comes with:</b>            2x Aircraft Cables            1x Power Feed Cable            1x Canopy Kit            • 2 Cord Power Drop Canopy Cover            • 1 Cord Power Drop Canopy Cover            • Canopy Cover Strain relief (2x)            • Canopy Cover Hardware kit            2x Upper Mounting Kit            • 2" canopy Cover            • T-Bar Clips</p>	<p><b>10 Ft Kit</b>  <b>93122350:</b> WHT with Dimming  <b>93122352:</b> BLK with Dimming  <b>93115847:</b> WHT No Dimming  <b>93115849:</b> BLK No Dimming  <b>20 Ft Kit</b>  <b>93122351:</b> WHT with Dimming  <b>93122353:</b> BLK with Dimming  <b>93115848:</b> WHT No Dimming  <b>93115850:</b> BLK No Dimming</p>
 <p>T-Grid clip + bolt</p>	<p><b>Suspended Kits - Direct Mounting Open/Unfinished Ceiling</b>  <b>Comes with:</b>            2x T-Grip Clips + bolts</p>	<p><b>93126294:</b> T-Grid Clip + bolt</p>
 <p>LDS Starter Kit</p>	<p><b>LDS Starter Kit</b>            (5 sets of endcaps &amp; knockout plates)</p>	<p><b>211994:</b> WHT            (kit qty = 5 sets)  <b>211995:</b> BLK            (kit qty = 5 sets)  <b>93051298:</b> Stainless Steel/Grey            (kit qty = 5 sets)</p>

# Lumination® LDS Series

Linear Suspended

**Photometric & Controls Data**

AGENT/DISTRIBUTOR NAME-LOGO \_\_\_\_\_

Project Name \_\_\_\_\_

Date \_\_\_\_\_ Type \_\_\_\_\_

Catalog Number \_\_\_\_\_

## CONTROLS COVERAGE DATA

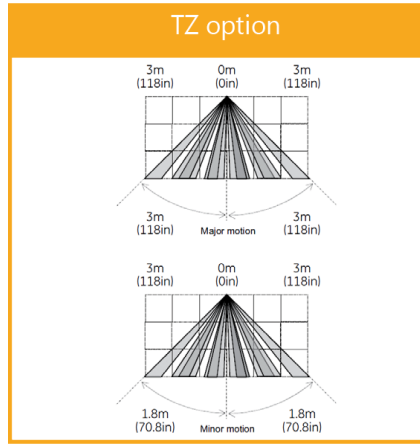
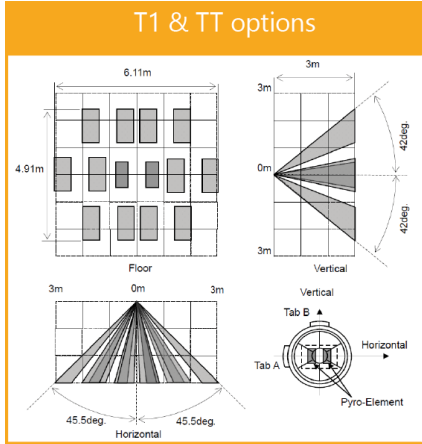

## PHOTOMETRIC DATA: LDS SERIES

**Distribution Narrow**  
3993 Lumens

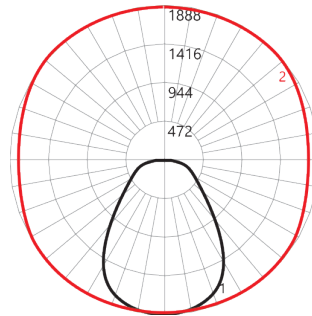

ZONE	LUMENS
0-10	175.00
10-20	501.45
20-30	733.69
30-40	747.87
40-50	596.59
50-60	469.07

ZONE	LUMENS	% OF FIXTURE
0-20	537.14	13.40
0-30	1131.35	28.30
0-40	1837.88	45.90
0-60	3199.99	80.00
0-80	3936.85	98.40
0-90	3992.86	99.80

**Distribution Wide**  
3993 Lumens

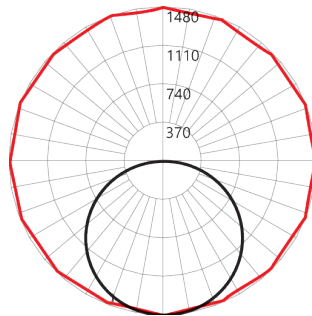

ZONE	LUMENS
0-10	139.63
10-20	397.53
20-30	594.23
30-40	706.56
40-50	721.43
50-60	640.73

ZONE	LUMENS	% OF FIXTURE
0-20	537.16	13.40
0-30	1131.39	28.30
0-40	1837.95	45.90
0-60	3200.11	80.00
0-80	3937.00	98.40
0-90	3993.02	99.80

# Lumination® LDS Series

Linear Suspended  
Photometric Data

## AGENT/DISTRIBUTOR NAME-LOGO

Project Name \_\_\_\_\_

Date \_\_\_\_\_ Type \_\_\_\_\_

Catalog Number \_\_\_\_\_

## PHOTOMETRIC DATA: LDS SERIES

### Wall Wash 3838 Lumens

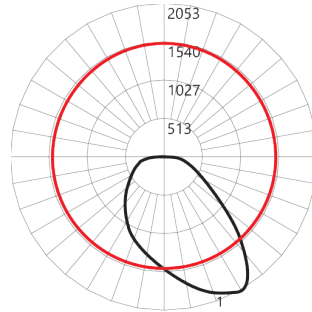

ZONE	LUMENS
0-10	151.85
10-20	443.98
20-30	683.39
30-40	743.76
40-50	608.43
50-60	470.32

ZONE	LUMENS	% OF FIXTURE
0-20	595.84	15.50
0-30	1279.22	33.30
0-40	2022.99	52.70
0-60	3101.73	80.80
0-80	3746.99	97.60
0-90	3837.66	100.00

### W1 - Wide + Uplight 8002 Lumens

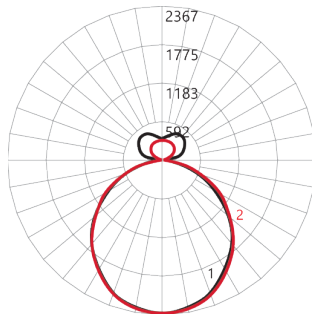

ZONE	LUMENS
0-10	223.44
10-20	636.13
20-30	950.96
30-40	1130.69
40-50	1154.62
50-60	1026.53
60-70	772.84
70-80	440.22
80-90	143.43
90-100	93.83
100-110	153.63
110-120	220.17
120-130	264.40
130-140	266.42
140-150	229.84
150-160	167.13
160-170	96.77
170-180	31.35

ZONE	LUMENS	% OF FIXTURE
0-20	859.58	10.70
0-30	1810.53	22.60
0-40	2941.22	36.80
0-60	5122.37	64.00
0-80	6335.42	79.20
0-90	6478.86	81.00
10-90	6255.41	78.20
20-40	2081.65	26.00
20-50	3236.26	40.40
40-70	2953.98	36.90
60-80	1213.05	15.20
70-80	440.22	5.50
80-90	143.43	1.80
90-110	247.46	3.10
90-120	467.63	5.80
90-130	732.03	9.10
90-150	1228.29	15.30
90-180	1523.53	19.00
110-180	1276.06	15.90
0-180	8002.38	100.00

### N1 - Wide + Uplight 8003 Lumens

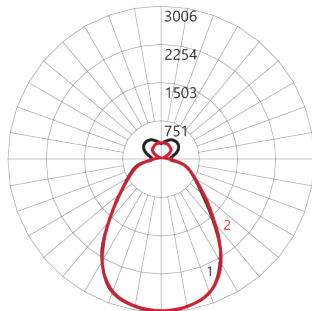

ZONE	LUMENS
0-10	284.16
10-20	811.53
20-30	1184.21
30-40	1220.11
40-50	970.21
50-60	742.23
60-70	609.43
70-80	461.06
80-90	196.95
90-100	93.97
100-110	153.53
110-120	219.96
120-130	264.22
130-140	266.31
140-150	229.89
150-160	167.29
160-170	96.93
170-180	31.41

ZONE	LUMENS	% OF FIXTURE
0-20	1095.69	13.70
0-30	2279.90	28.50
0-40	3500.01	43.70
0-60	5212.45	65.10
0-80	6282.94	78.50
0-90	6479.89	81.00
10-90	6195.72	77.40
20-40	2404.32	30.00
20-50	3374.52	42.20
40-70	2321.87	29.00
60-80	1070.49	13.40
70-80	461.06	5.80
80-90	196.95	2.50
90-110	247.50	3.10
90-120	467.46	5.80
90-130	731.67	9.10
90-150	1227.88	15.30
90-180	1523.51	19.00
110-180	1276.02	15.90
0-180	8003.40	100.00

### L1 - Wide + Uplight 8003 Lumens

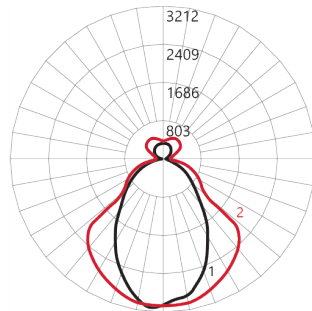

ZONE	LUMENS
0-10	293.92
10-20	815.43
20-30	1159.95
30-40	1271.31
40-50	1149.67
50-60	766.88
60-70	558.03
70-80	333.32
80-90	133.17
90-100	93.17
100-110	152.91
110-120	219.47
120-130	263.94
130-140	266.20
140-150	229.91
150-160	167.37
160-170	97.02
170-180	31.46

ZONE	LUMENS	% OF FIXTURE
0-20	1109.35	13.90
0-30	2269.30	28.40
0-40	3540.60	44.20
0-60	5457.15	68.20
0-80	6348.51	79.30
0-90	6481.67	81.00
10-90	6187.75	77.30
20-40	2431.25	30.40
20-50	3580.92	44.70
40-70	2474.58	30.90
60-80	891.35	11.10
70-80	333.32	4.20
80-90	133.17	1.70
90-110	246.08	3.10
90-120	465.55	5.80
90-130	729.49	9.10
90-150	1225.59	15.30
90-180	1521.44	19.00
110-180	1275.36	15.90
0-180	8003.11	100.00

For Additional Information or Product Technical Questions:  
lightingprodinfo@gecurrent.com