



CUSTOMER NAME _____

Project Name _____

Date _____ Type _____

Catalog Number _____

Current's Lumination LED fixtures with TriGain® technology **LIS Suspended** Series are designed to offer lighting designers enhanced CRI and R9 without sacrificing efficiency. With R9 greater than 90, these fixtures optimally display objects like produce, fabric, skin-tones and artwork—all with a remarkably efficient 158 lumens per watt, reducing maintenance and operating costs. Available in 7% and 12% upright versions as well.

CONSTRUCTION

Heatsink: Fully Recyclable Heatsink
Paint: White, Colored Endcaps (optional)
Weight: <20lb (9.07kg)

OPTICAL SYSTEM

Lumens: 4,200–24,000
Distribution: Lambertian, 100% Direct, 12% Uplight, 7% Uplight
Wattage: 34–182W
Efficacy: Up to 158 LPW
CCT: 3000K, 3500K, 4000K & 5000K
CRI: 83, 90 TriGain®

ELECTRICAL

Input Voltage: 120–277V, 347V
Input Frequency: 50/60Hz
Power Factor (PF)*: >90%*
Total Harmonic Distortion (THD)*: <20%**
Transient Protection: 100 kHz ring wave, 2.5 kV level
LED Driver Type: Class 2, Replaceable, High Efficiency LED Driver rated for 50,000 hours (When used within operating conditions.)
Audible Noise: Per 29CFR 1910 sub part G: <24 dba (1 foot)
Output Frequency/Flicker Rate: NEMA 77

*except for the following conditions:
 • 4ft SKU with [A3] lumen
 • 4ft SKU with [EL] option

** PF and THD may vary with options

CONTROLS

Dimming Control: Standard, 0–10V Universal
Sensors: Occupancy & Daylight Harvesting Sensor, Daintree® EZ Connect, Daintree® One, & Daintree® Networked available w/ Integrated Sensor

LUMEN MAINTENANCE

L70 @ 100,000 hours

L70

LUMEN AMBIENT TEMPERATURE

TYPE	TEMPERATURE RATE
OPERATING TEMPERATURE	-10°C to 35°C
STORAGE TEMPERATURE	-40°C to +70°C

MOUNTING & ADDITIONAL FEATURES

- **Mounting Options:** Ceiling, Surface, Suspended
- **Removable Light Engine:** Available
- **Continuous Runs:** Up to 400' on a single power drop
- **Quick-Connect Design:** Eliminates snaking for straight lines and helps cut installation time.
- **Optional Uplight Distribution:** Available with two upright configurations to reduce shadowing and dark ceilings.
- **Optional Decorative Endcaps:** Black, Grey, or Red
- **Optional Emergency Battery:** Bodine BSL310 battery back-up system

DESIGN LIFE & WARRANTY

- **Rated Life:**
 - L70 @ 90,000 hours for Trigain® only
 - L85 @ 75,000 hours
- **High Temperature High Humidity:** 60°C / 90% (non-condensing)
- **Safety:** UL/cUL Listed
- **Ratings:** IP20, IK02
- **Electronic Vibration Testing:** Multi Axis, Random Vibration Profile: 2-2000 Hz, 5Gs on electronics
- **Current's Limited 5-year Warranty:** Please refer to [IND599](#) in Product Downloads section at: <https://products.gecurrent.com>



CUSTOMER NAME

Project Name _____

Date _____ Type _____

Catalog Number _____

Ordering Number Logic

FAMILY	FIXTURE TYPE	GENERATION	VOLTAGE	NOMINAL LUMEN	DISTRIBUTION	CRI	CCT	CONTROLS	MOUNTING	FINISH	OPTIONS
LIS	C4 ² = 4 ft Continuous C8 ² = 8 ft Continuous I4= 4 ft Independent I8= 8 ft Independent	B = Replaceable Light Engine (90CRI) C = Replaceable Light Engine (83CRI)	O = 120–277 VAC D = 347 VAC	4 ft Only	D1 = 100% Direct D8 = 12% Uplight D9 = 7% Uplight	P ³ = 90 CRI 8 = 83 CRI	30 = 3000K 35 = 3500K 40 = 4000K 50 = 5000K	VQ = 0–10V VT = 0–10V, Daintree® Networks S1 ⁴ = On/Off Occ. Sensor S2 ^{4,5} = 0–10 V, On/Off Occ. & Daylight Harvesting Sensor T1 ⁶ = Daintree® One w/ fixture integrated sensor, factory programmed preset TT ⁶ = Daintree® EZ Connect Wireless w/fixture integrated sensor TZ ⁶ = Daintree® Enterprise Wireless w/ fixture integrated sensor	CS = (See accessories page below for further accessory/ mounting options which have to be ordered separately) <i>2 mounting brackets come included with each fixture.</i>	WHITE = White	Blank = No Options A ¹ = Branch Circuit EL ^{7,8,9} = Emergency Light BP = Bulk Pack BC ¹⁰ = Black End Cap GC ¹⁰ = Grey End Cap RC ¹⁰ = Red End Cap HE ¹¹ = High Efficiency Fixture P10 ^{12,13} = 10 ft (14 AWG 5 cond) Power Cord White P20 ^{12,13} = 20 ft (14 AWG 5 cond) Power Cord White SPL ^{12,13} = Sample with 6 ft cord and 120 VAC wall plug WP = White Painted
				8 ft Only							

ORDERING NOTES:

- A option not available for '14' & '18' fixture type.
- Starter kit required (see accessory page below).
- 90 CRI available with the below lumen levels:
 - 4 ft (42 & 52 only)
 - 8 ft (84 & A0 only) *In the 3500K and 4000K CCT only.*
- S1&S2 controls only available with 120V/277V input voltage.
- Order programming remote (197634).
- Not available with 347V or EL option.
11' Mounting height limitation.
- EL option is only available with the below lumen levels:
 - 4 ft (42, 52, 62, 65 & 85 only)
 - 8 ft (84, A0, A2, A3 & A7 only)
- EL option not available with 347V.
- EL option available with VQ Controls only.
- RC, BC, GC options only available with I4 & I8 fixture type.
- HE only available with 120/277V input voltage, 83 CRI and lumen levels (42, 52, 84, A0).
- Only 1 cord option (SPL, P10 or P20) per SKU.
- Cord options (SPL, P10, P20) not available with: EL or A options, 347V input voltage, C4 & C8 fixture type.

PERFORMANCE TABLES

CRI 83					
DIMENSIONS	OPTICAL CODE	CCT	LUMENS	POWER	LPW
4 ft	42840	4000	4200	31.0	135.5
	52840	4000	5200	38.0	136.8
	62840	4000	6250	48.5	128.9
	65840	4000	6500	43.2	150.5
	85840	4000	8500	58.3	145.8
	A1840	4000	10500	75.0	140.0
	A2840	4000	12300	89.6	137.3
8 ft	84840	4000	8400	60.0	140.0
	A0840	4000	10400	72.0	144.4
	A2840	4000	12500	96.0	130.2
	A3840	4000	13000	86.5	150.3
	A7840	4000	17000	113.0	150.4
	B1840	4000	21100	150.0	140.7
	B4840	4000	24500	182.0	134.6

- NOTE:**
- Lumen Multiplier = 0.95 for CCT = 3000K
 - Lumen Multiplier = 0.97 for CCT = 3500K
 - Lumen Multiplier = 1.02 for CCT = 5000K
 - Power Multiplier = 1.07 for 347V
 - 4 Watt increment for EL option
 - 2 Watt increment for S1, S2, T1, TT, TZ, VT option

TRIGAIN®, CRI 90+					
DIMENSIONS	OPTICAL CODE	CCT	LUMENS	POWER	LPW
4 ft	42P35	3500	4000	31	129.0
	42P40	4000	4200	31	135.5
	52P35	3500	5000	38	131.6
	52P40	4000	5200	38	136.8
8 ft	84P35	3500	8000	60	133.3
	84P40	4000	8400	60	140.0
	A0P35	3500	9900	72	137.5
	A0P40	4000	10,400	72	144.4

- NOTE:**
- 4 Watt increment for EL option
 - 2 Watt increment for S1, S2, T1, TT, TZ, VT option
 - Power Multiplier = 1.07 for 347V

HIGH EFFICIENCY (HE) OPTION					
DIMENSIONS	OPTICAL CODE	CCT	LUMENS	POWER	LPW
4 ft	42840	4000	4200	27	155
	52840	4000	5200	34	153
8 ft	84840	4000	8400	53	158
	A0840	4000	10400	66	158

- NOTE:**
- HE option ONLY Lumen multiplier:
 - CCT = 3500K → 0.97
 - CCT = 5000K → 1.02
 - Not available in [T] CRI
 - Only available for following lumen code: [42] & [52] for 4 ft., [84] & [A0] for 8 ft.

CUSTOMER NAME

Project Name _____

Date _____ Type _____

Catalog Number _____

FACTORY INSTALLED STARTER KIT

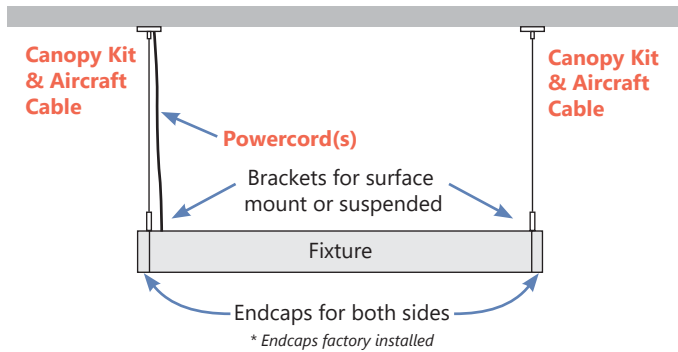

● **RED** indicates items that must be ordered as options or accessories.

FIELD INSTALLED IS ONE STARTER KIT PER RUN,
ORDERED SEPARATELY.

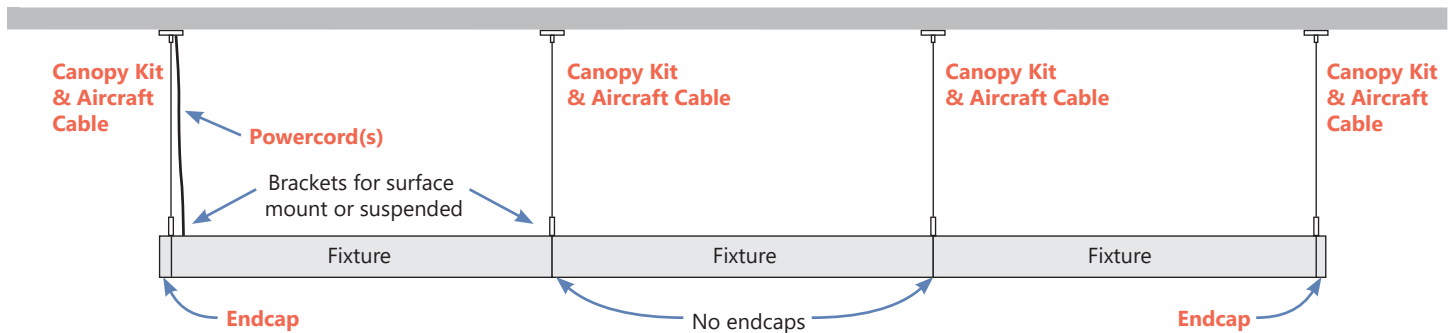

● **RED** indicates items that must be ordered as options or accessories.
The starter, when suspended, is normally the only fixture in the row with (2) suspension hangers.
The rest of the run may be suspended from a single hanger.

CUSTOMER NAME

Project Name _____

Date _____ Type _____

Catalog Number _____

PRODUCT DIMENSIONS

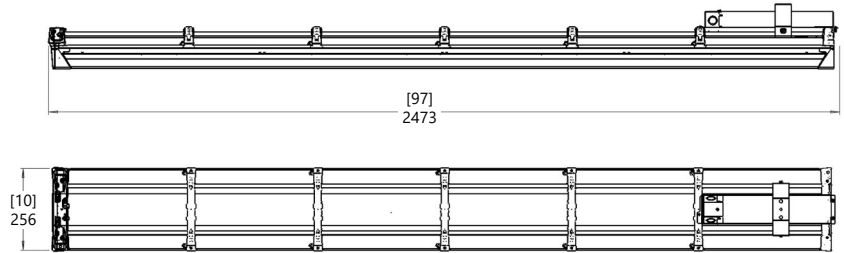
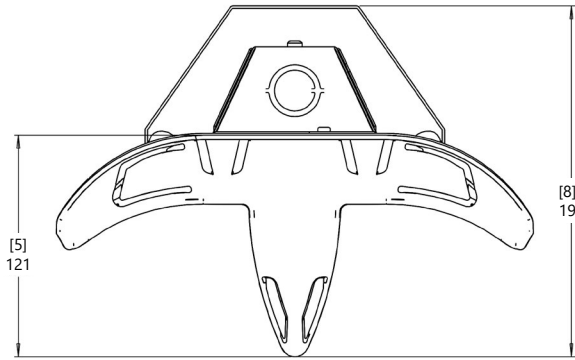

CONFIGURATION INDEPENDENT	4 FT	8 FT
Length "L" (Inches)	49	97
Length "L" (MM)	1256	2473
Length "L" w/SENSOR (Inches)	56	104
Length "L" w/SENSOR (MM)	1432	2643





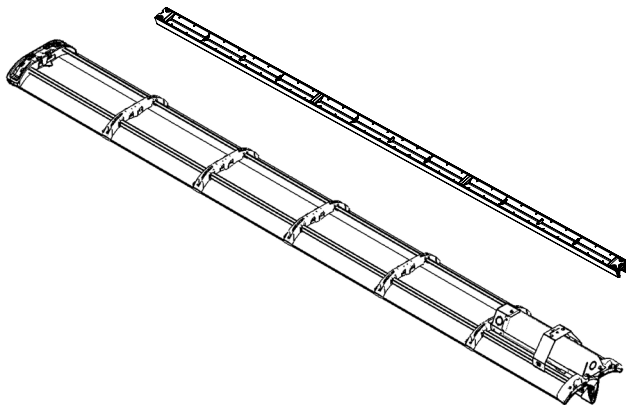

*Continuous fixtures are exactly 48" and 96" long

LIS REPLACEABLE LIGHT ENGINE



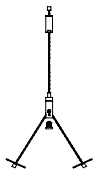
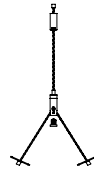

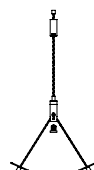
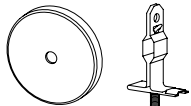
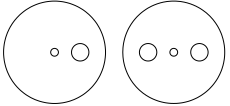
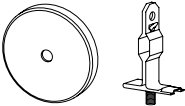
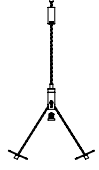
Supply Voltage	MAXIMUM RUN LENGTH PER 1 POWER DROP			
	8FT LUMEN CODE			
	[84]	[A0] [A2]	[A3] [A7]	[B1] [B4]
120V	192'	160'	80'	60'
277V or 347V	400'	320'	188'	132'

ACCESSORIES

MOUNTING/ACCESSORY OPTIONS		PRODUCT CODE
SAMPLE SKU: LISI4B042D1P40VQCSWHTESPL		93073490
<p>POWER CORD KIT Options Comes with:</p> <ul style="list-style-type: none"> • 1x Power Feed Cable • 1x Strain Relief 	 <p>Power Feed Cable (4 cond; includes black, white, green and red (for additional circuit))</p>  <p>Dimming Feed Cable (2 cond; includes purple and gray)</p> <p><small>**Power and Dimming Feed Cables are #14 gauge 600V rated</small></p>	<p>10 FT KIT 93083221: BLK 93083222: WHT</p> <p>20 FT KIT 93083223: BLK 93083224: WHT</p>
<p>SUSPENDED KITS Mounting Open/Unfinished Ceiling Comes with:</p> <ul style="list-style-type: none"> • 2x Aircraft Cables • 1x Strain Relief 	 <p>Mounting Cables</p>	<p>10 FT KIT 93035285: 10' Kit</p> <p>20 FT KIT 93116031: 20' Kit</p>
<p>SUSPENDED KITS Mounting + Power Open /Unfinished Ceiling Comes with:</p> <ul style="list-style-type: none"> • 2x Aircraft Cables • 1x Power Feed Cable 	 <p>Mounting Cables</p>  <p>Power Feed Cable (4 cond; includes black, white, green and red (for additional circuit))</p>  <p>Dimming Feed Cable (2 cond; includes purple and gray)</p> <p><small>**Power and Dimming Feed Cables are #14 gauge 600V rated</small></p>	<p>10 FT KIT 93122346: WHT with Dimming 93122348: BLK with Dimming 93115897: WHT No Dimming 93115899: BLK No Dimming</p> <p>20 FT KIT 93122347: WHT with Dimming 93122349: BLK with Dimming 93115898: WHT No Dimming 93115900: BLK No Dimming</p>
<p>SUSPENDED KITS Mounting + Power Open /Unfinished Ceiling Comes with:</p> <ul style="list-style-type: none"> • 2x Aircraft Cables • 2x Upper Mounting Kit <ul style="list-style-type: none"> ◦ 2" canopy Cover ◦ T-Bar Clips 	 <p>Mounting Cables</p>  <p>Upper Mounting Kit</p>	<p>10 FT KIT 93115708: WHT Canopy 93115710: BLK Canopy</p> <p>20 FT KIT 93115709: WHT Canopy 93115711: BLK Canopy</p>
<p>SUSPENDED KITS Mounting + Power Finished Ceiling Comes with:</p> <ul style="list-style-type: none"> • 2x Aircraft Cables • 1x Power Feed Cable • 1x Canopy Kit <ul style="list-style-type: none"> ◦ 2 Cord Power Drop Canopy Cover ◦ 1 Cord Power Drop Canopy Cover ◦ Canopy Cover Strain relief (2x) ◦ Canopy Cover Hardware kit • 2x Upper Mounting Kit <ul style="list-style-type: none"> ◦ 2" canopy Cover ◦ T-Bar Clips 	 <p>Canopy Kit</p>  <p>Upper Mounting Kit</p>  <p>Mounting Cables</p>  <p>Power Feed Cable (4 cond; includes black, white, green and red (for additional circuit))</p>  <p>Dimming Feed Cable (2 cond; includes purple and gray)</p> <p><small>**Power and Dimming Feed Cables are #14 gauge 600V rated</small></p>	<p>10 FT KIT 93122350: WHT with Dimming 93122352: BLK with Dimming 93115847: WHT No Dimming 93115849: BLK No Dimming</p> <p>20 FT KIT 93122351: WHT with Dimming 93122353: BLK with Dimming 93115848: WHT No Dimming 93115850: BLK No Dimming</p>

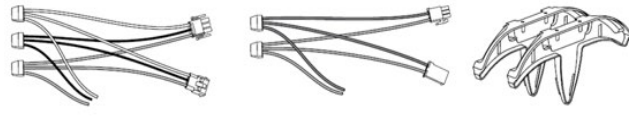
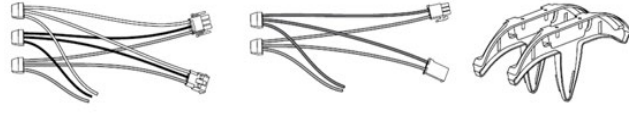
ADDITIONAL ACCESSORIES

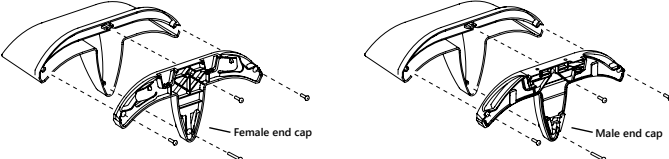
MOUNTING/ACCESSORY OPTIONS		PRODUCT CODE
<p>SUSPENDED KITS Direct Mounting Open/Unfinished Ceiling</p> <p>Comes with:</p> <ul style="list-style-type: none"> • 2x T-Grid Clips + bolts 	 <p>T-Grid Clip + Bolt</p>	<p>T-GRID CLIP + BOLT 93126294</p>
<p>Starter Kit (1 row)</p> <p>Comes with:</p> <ul style="list-style-type: none"> • 1x Starter Harness • 2x Endcaps 	 <p>Starter Kit Harnesses Endcaps</p>	<p>END CAPS COLORS</p> <p>93018007: WHT End Caps 93081607: GRY End Caps 93081606: BLK End Caps 93081609: RED End Caps</p>
<p>Starter Kit (10 rows)</p> <p>Comes with:</p> <ul style="list-style-type: none"> • 10x Starter Harness • 20x Endcaps 	 <p>Starter Kit Harnesses Endcaps</p>	<p>END CAPS COLORS</p> <p>93022791: WHT End Caps 93081608: GRY End Caps 93081245: BLK End Caps 93081610: RED End Caps</p>
<p>Anti-Snaking Brackets</p> <p>Use if extra brackets are required. See diagram on next page—brackets included with each fixture</p> <p>Comes with:</p> <ul style="list-style-type: none"> • 10x Suspension Brackets 	 <p>Starter Kit Harnesses</p>	<p>94210: Standard Suspension Brackets 93088000: Anti-Snaking Suspension Brackets</p>
<p>Architectural End Cap</p>	 <p>Female end cap Male end cap</p>	<p>93039940: Contains set (2)</p>

SENSOR COVERAGE PATTERN

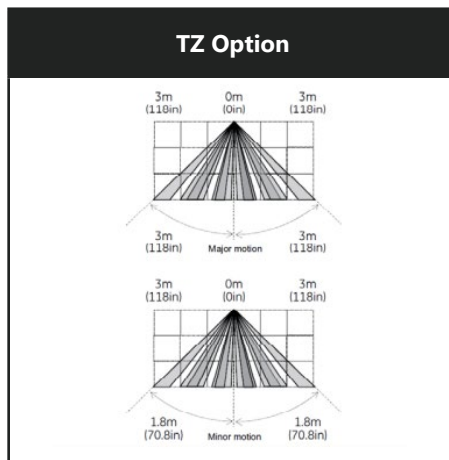
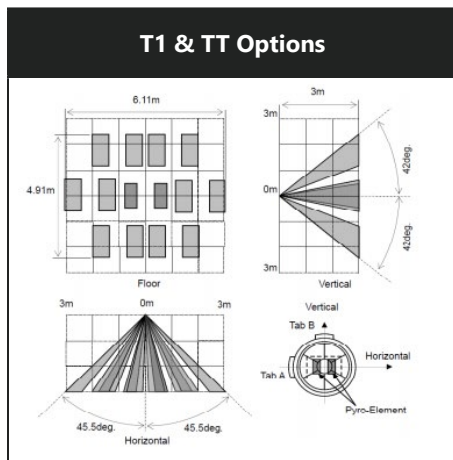

CUSTOMER NAME

Project Name _____

Date _____ Type _____

Catalog Number _____

LUSI8 SERIES

L-IS-X8-BX84DIP40-VQCS-WHTE-XX

ZONAL LUMEN SUMMARY	
Zone	Lumens
0-10	227.53
10-20	666.91
20-30	1044.13
30-40	1331.00
40-50	1491.13
50-60	1477.78
60-70	1252.06
70-80	787.23
80-90	207.36
90-100	67.52
100-110	29.05
110-120	9.49
120-130	2.05
130-140	1.79
140-150	1.76
150-160	1.62
160-170	1.14
170-180	0.43

COEFFICIENTS OF UTILIZATION																				
RC	80%				70%				50%				30%				10%			
	RW	70%	50%	30%	10%	70%	50%	30%	10%	50%	30%	10%	50%	30%	10%	50%	30%	10%	0%	
0	119	119	119	119	116	116	116	116	110	110	110	105	105	105	101	101	101	99		
1	107	102	98	93	105	100	96	92	95	92	89	91	88	86	87	85	83	81		
2	97	88	81	74	94	86	79	73	82	76	71	79	74	70	75	71	68	65		
3	88	76	68	61	85	75	67	60	71	64	59	68	62	58	66	61	56	54		
4	80	67	58	51	77	66	57	50	63	55	49	60	54	48	58	52	48	45		
5	73	59	50	43	71	58	49	43	56	48	42	54	47	41	52	46	41	39		
6	67	53	44	37	65	52	43	37	50	42	36	48	41	36	47	40	35	33		
7	62	48	39	32	60	47	38	32	45	38	32	44	37	32	42	36	31	29		
8	58	44	35	29	56	43	34	29	41	34	28	40	33	28	39	32	28	26		
9	54	40	31	26	52	39	31	26	38	31	25	37	30	25	36	29	25	23		
10	50	37	29	23	49	36	28	23	35	28	23	34	27	23	33	27	22	21		

NOTE: Floor Cavity Reflectance : 20%

ZONAL LUMEN SUMMARY			
Zone	Lumens	% of Lamp	% of Fixture
0-20	894.44	N.A.	10.40
0-30	1938.57		22.50
0-40	3269.58		38.00
0-60	6238.49		72.50
0-80	8277.78		96.30

CANDLEPOWER SUMMARY			
Angle	0°	45°	90°
45°	3876	4368	4659
55°	3906	4717	4919
65°	3926	4995	4964
75°	3866	4988	4225
85°	3389	2511	2399

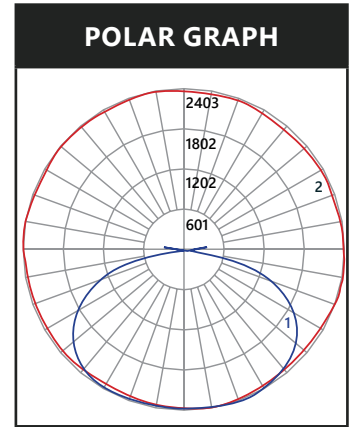

EMERGENCY BATTERY OPTION

- Luminaires with the "EL" option code come equipped with a Bodine BSL310 battery back-up system to provide lighting during power interruptions.

- To calculate delivered lumens for an EL equipped luminaire use the following formula:

Emergency Mode Lumens = P x LPW

"P" is the output power of the emergency system (10W for "EL")

"LPW" is the efficacy of the system as determined from the performance data

- For more information refer to:

<https://www.signify.com/en-us/brands/bodine/products/led-emergency-drivers/bsl310>

- For more information and access to all of our resources, including our design tool visit:

products.gecurrent.com

INSTALLATION

- When ordering Lumination IS Series LED Luminaires 2 mounting brackets are included with each fixture.
- Additional mounting brackets can be ordered if needed, depending upon mounting and spacing of application.