

Project		Catalog #		Type	
Prepared by		Notes		Date	



Fail-Safe



MCL / MHN / MSN / MLN

- 3" x 5" Nominal Size
- Die-cast Aluminum Face-plate
- Universal Voltage
- Clear Protective Polycarbonate Lens
- Thru Wall Available

Typical Applications

Healthcare, Corridors, Patient Rooms, Bathrooms

Interactive Menu

- Order Information [page 2](#)
- Product Specifications [page 3](#)
- Product Warranty

Product Certification



Product Features



Top Product Features

- Fits into standard single gang junction box for easy installation - 3" x 5" nominal face-plate size
- White and black face-plate standard. Custom colors available.
- Die-cut gasket standard for wet location applications, under covered ceiling (MHN, MLN, MSN)
- Universal voltage 120V-277V standard
- Clear polycarbonate lens, 0.040" thick, for protection and durability
- Anti-microbial matte white paint standard on face-plate

Dimensional and Mounting Details

For more detailed dimensions, refer to page 3.

MLN

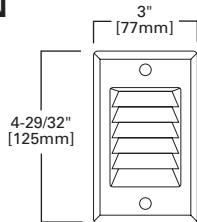

MHN

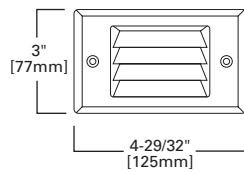

MCL (On/off push-button switch or photocell)

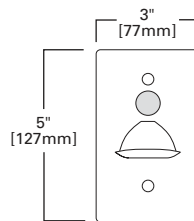

MSN

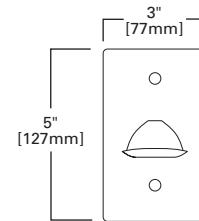

[additional product diagrams](#)

MLN / MHN / MSN Order Information

SAMPLE ORDER NUMBER: **MSN-UNV-W**

SAMPLE ORDER NUMBER: **BAA-MHN-UNV-W**

Domestic Preferences	Product Family	Voltage	Faceplate Color
Domestic Preferences ⁽¹⁾	Product Family	Voltage	Faceplate Color ⁽⁴⁾
[Blank] =Standard BAA =Buy American Act	MHN =Medical Horizontal Louver ^{(2),(3)} MLN =Medical Louver Nightlight ^{(2),(3)} MSN =Medical Scoop Nightlight ^{(2),(3)}	UNV =120V-277V	W =Matte White Paint Anti-Microbial B =Black Paint, Gloss
Notes (1) Only product configurations with these designated prefixes are built to be compliant with the Buy American Act of 1933 (BAA), respectively. Please refer to DOMESTIC PREFERENCES website for more information. Components shipped separately may be separately analyzed under domestic preference requirements.	Notes (2) Wet location standard on MLN, MHN and MSN. (3) Standard white (4000K) LEDs and a clear polycarbonate lens.		Notes (4) Specify RAL number, paint manufacturer catalog number, or supply a sample. Consult FailSafe Tech as necessary.

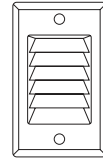

MLN

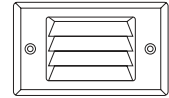

MHN

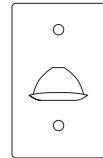

MSN

MCL Order Information

SAMPLE ORDER NUMBER: **MCL-W-UNV-W**

BAA-MCL-W-UNV-B-PHC

Domestic Preferences	Product Family	LED Color	Voltage	Faceplate Color	Style	Options
Domestic Preferences ⁽¹⁾	Product Family	LED Color ⁽²⁾	Voltage	Faceplate Color ⁽³⁾	Style	Options
[Blank] =Standard BAA =Buy American Act	MCL =Medical Chart Light	W =White A =Amber	UNV =120V-277V	W =Matte White Paint Anti-Microbial B =Black Paint, Gloss	[Blank] =On/Off Button, Illuminated. Depress Button to Energize Unit.	PHC =Photocell (in place of standard on/off switch ^{(4),(5)})
Notes (1) Only product configurations with these designated prefixes are built to be compliant with the Buy American Act of 1933 (BAA), respectively. Please refer to DOMESTIC PREFERENCES website for more information. Components shipped separately may be separately analyzed under domestic preference requirements.		Notes (2) White LEDs are 4000K, Amber LEDs are 610nm +/-10nm.		Notes (3) Specify RAL number, paint manufacturer catalog number, or supply a sample. Consult FailSafe Tech as necessary.		Notes (4) The MCL version of Circadian is supplied with a photo optic cell which turns the light source (LED) off when the ambient light rises above the MCL set point or threshold. In a very limited number of applications, where the sustained ambient light is at or near the MCL set point, the user may experience "flickering" of the light. To avoid "flickering", do not install the MCL in areas such as in dark shadows or dark corners. Should flickering occur, relocate the MCL to an area of higher ambient light. (5) Photocell on/off button - not both.

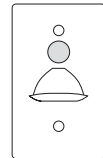

MCL

Description

Nightlights and chart lights bring soft, low level illumination to any environment. Fitting into a standard junction box (single-gang, handy box, 2" minimum inside width) for easy installation, the MCL, MSN, MHN and MLN operate on 120V-277V, delivering up to 30 lumens of illumination. The MCL Chart Light has an illuminated push-button switch. Depress the switch to energize the unit. A Thru Wall Junction Box is available, that accommodates wall thickness from 3 1/2" to 6", and uses two night lights.

Thru Wall Junction Box (order as separate line item)

Order as "TWJB"

Use (1) TWJB with (2) Night Lights
TWJB can be rotated 90° and be used with the MHN



Tamper-resistant Screws (order as separate line item)

TP-SCREW-2-T10 WHT PK=T10 Tamper resistant white screws, qty. 2

TP-SCREW-2-T10 BLK PK=T10 Tamper resistant black screws, qty. 2

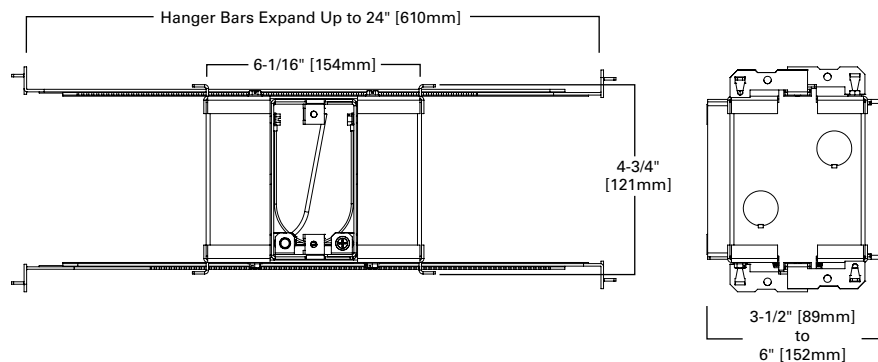

Dimensional and Mounting Details

MLN

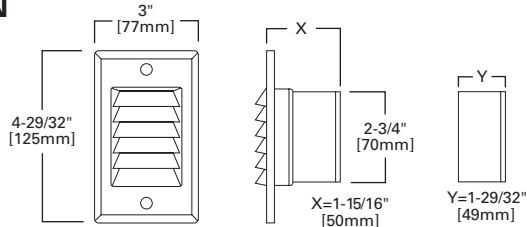

MHN

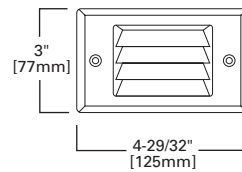

MCL (On/off push-button switch or photocell)

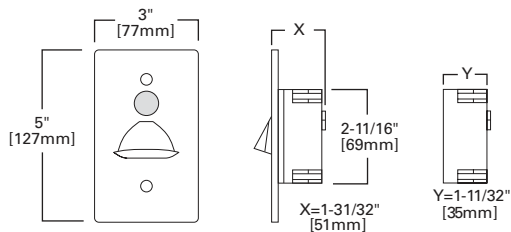

MSN

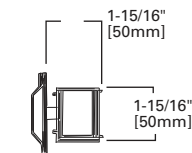
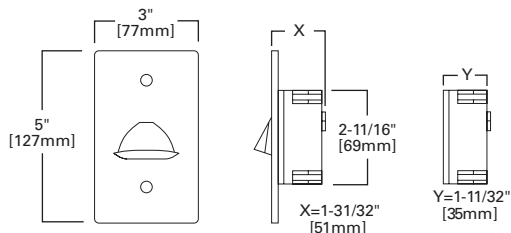

For retrofit applications, check width, height and depth of existing junction box. Requires 2" minimum inside width.

Specifications

	MLN / MHN	MCL / MSN
Illumination	Minimum 30 Lumens	Minimum 30 Lumens
Input Wattage	< 5 Watts	< 5 Watts
Face Plate	Die-cast aluminum	Die-cast aluminum
Code Compliance	UL 1598	UL 1598
Input Voltage	120V-277V	120V-277V
Mounting / Installation	Single-gang junction box (2" minimum inside width)	Single-gang junction box (2" minimum inside width)
Labels	UL listed	UL listed

Product Specifications

Mounting / Installation

- Fits into standard junction box for easy installation (single-gang, handy box, 2" minimum inside width)

Faceplate

- Unique face-plate design distributes light evenly
- Die-cast aluminum louvered or scoop faceplates
- Matte white anti-microbial painted faceplate standard; black paint option available - gloss finish

Photocell

- Threshold values; MCL energizes at nominal 2 vertical foot candles. Unit extinguishes at nominal 10 vertical footcandles.

LED

- Standard white is 4000K. Amber peak wavelength is 610nm (+/- 10nm). Full width half max. is 95nm (+/-10nm).

Protective Lens

- Clear, 0.040" thick clear polycarbonate protective lens, standard
- MCL: Clear acrylic lens, 0.040" thick
- Thru Wall Junction Box: Night lights (2) fit into the galvanized steel junction box. Order on a separate line item

Wattage

- < 5 input watts

Labels

- MLN, MHN: Wet location listed, under covered ceiling
- MSN: Wet location listed above 4' mounting height, under covered ceiling
- MCL: Dry location listed
- Options to meet Buy American Act requirements

Warranty

- 3 year limited warranty