



CUSTOMER NAME _____

Project Name _____

Date _____ Type _____

Catalog Number _____

Albeo® PHB Series

Selectable Lumen & CCT Linear High Bay

The **Albeo® PHB Series** Linear High Bay offers the right combination of options in each stocked SKU to satisfy your job needs. With 120-347V, selectable lumens and CCT, field-installable sensors, factory integrated emergency battery and mounting accessories, the PHB is the ideal solution for a wide range of industrial and commercial applications up to 39 ft. mounting heights.

CONSTRUCTION

Housing:	Die-cast Aluminum
Lens:	Diffused Polycarbonate
Weight:	Size 1X: 5.0 lbs (2.3 kg) Size 2X: 6.5 lbs (2.9 kg)

PERFORMANCE

Distribution:	Narrow (55°) **, Medium (90°) and Wide (120°) **
Lumens:	1X: Selectable 15,000 / 18,000 / 24,000 2X: Selectable 27,000 / 30,000 / 36,000
Efficacy:	Up to 161 LPW
CCT:	Selectable 4000K / 5000K
CRI:	80

** Available as field installed accessories

ELECTRICAL

Input Voltage:	120-347V
Input Frequency:	50/60 Hz
Power Factor (PF)*:	>90%*
Total Harmonic Distortion (THD)*:	>20*
Color Rendering Index	>80
EMI:	FCC CFR Title 47 Part 15, Class A
LED Driver Type:	6kV surge protection
Emergency Drivers:	120-347V

* PF and THD may vary with options

CONTROLS

Sensors:	Field installable PIR Occupancy Sensor
Dimming:	0-10V Dimming to 10%

LUMINAIRE AMBIENT TEMPERATURE

Size	TEMPERATURE RATE
1X	-40°C to +55°C (-40°F to 131° F)
2X	-40°C to +50°C (-40°F to 122° F)

LUMEN MAINTENANCE

LXX(10K) @ Hours 100,000 HR
L70

ADDITIONAL FEATURES

- **Typical Mounting:** Each fixture comes standard with 3' chain and v-hooks included in the box.
- Surface and pendant mount accessories available
- Optional factory-installed integral emergency battery pack (CEC Title 20 Compliant)
- Optional sensor remote accessory allows daylight and dimming sensor capabilities to be enabled and programmed

DESIGN LIFE & WARRANTY

- **Reliability Testing:** Components and/or systems evaluation at extreme conditions and monitored during production
- Please refer to the DLC QPL website for the latest and most complete information: <http://www.designlights.org/QPL>
- UL 1598 to US and Canadian Standards Suitable for Damp Locations
- **Current's Limited 5-year Warranty:**
See Product Warranties section at led.com/resources



ORDERING INFORMATION

PHB 1 08 MD QV ST K Q W

PRODUCT ID	VOLTAGE	SIZE/LUMENS	CCT/CRI	OPTICS ¹	CONTROLS	MOUNTING	CORD	PLUG	FINISH	OPTIONS
PHB = Albeo Linear Highbay	1 = 120-347V	1X = Selectable 15/18/24K 2X = Selectable 27/30/36K	08 = Selectable 4000/5000K (80CRI)	MD = Medium (90°) Distribution	QV = 0-10V Dimming	ST = Standard Mounting Note = V-hooks and 3-ft chain included ²	K = Knockout	Q = None	W = White	E25 = 25W integrated emergency battery (CEC Title 20 Compliant) ^{3,4}

ORDERING NOTES:

- Narrow (55°) and Wide (120°) distributions are available by ordering lens accessories and field installing
- V-hooks and 3-ft chain included
- To determine lumen output in emergency mode multiply the battery pack wattage by the fixture lumens per watt (LPW)
- Fixtures equipped with the ELL25 are not compatible with Surface Mount Kit and Pendant Mount Kit mounting options

SKU	CATALOG NUMBER	VOLTAGE	SIZE/LUMEN PACKAGE	DISTRIBUTION	TYPICAL DELIVERED LUMENS	WATTS	TYPICAL LPW	MAX AMBIENT TEMP (° C)
93167910	PHB11X08MDQVSTKQW	120-347V	1X	Medium (90°)	15,500	97	161	55° C ¹
					18,400	118	156	
					24,000	160	150	
93167913	PHB12X08MDQVSTKQW	120-347V	2X	Medium (90°)	27,600	175	158	50° C ²
					30,400	196	155	
					36,200	242	150	

ORDERING NOTES:

- PHB 1X is rated for 55°C when mounted 18 inches below the ceiling. 35°C max ambient rating when surface mounted.
- PHB 2X is rated for 50°C when mounted 18 inches below the ceiling. 30°C max ambient rating when surface mounted.

ACCESSORY OPTIONS (ORDER SEPARATELY)

ACCESSORY	IMAGE	ORDER SKU #	DESCRIPTION	DIMENSIONS/NOTES
PIR Occupancy Sensor		93313943	Switchable Linear High Bay PIR-SENSOR	1. Easy plug-and-play install to front face of fixture. 2. Sensor requires remote if programming is desired.
Sensor Remote		95059859	Switchable Linear High Bay REMOTE	1. Remote allows default settings to be changed. 2. Remote allows daylight and dimming sensor capabilities to be enabled and programmed.
Wire Guard		93310168	PHB WIRE GUARD 1	For use on PHB Size 1X
		93310169	PHB WIRE GUARD 2	For use on PHB Size 2X
Replacement Lens		93310170	PHB Wide-LENS 1	Wide Distribution (120°) lens for use on PHB Size 1X
		93310171	PHB Wide-LENS 2	Wide Distribution (120°) lens for use on PHB Size 2X
		93310172	PHB Medium-LENS 1	Medium Distribution (90°) lens for use on PHB Size 1X
		93310173	PHB Medium-LENS 2	Medium Distribution (90°) lens for use on PHB Size 2X
		93310174	PHB Narrow-LENS 1	Narrow Distribution (55°) lens for use on PHB Size 1X
93310175	PHB Narrow-LENS 2	Narrow Distribution (55°) lens for use on PHB Size 2X		
Surface Mount Kit		93311605	Switchable Linear High Bay SURFACE	Use for Size 1X & 2X Not compatible with fixtures that have ELL25 battery pack installed
Pendant Mount Kit		93310166	Switchable Linear High Bay PENDANT	Use for Size 1X and 2X Stems not included Not compatible with fixtures that have ELL25 battery pack installed
Y- Cable/ Hooks (Pair)		93302310	5ft Y-Cable/Hook	1. To be installed using V clips included with each fixture. Only requires (1) Y-Cable Hook per fixture.
		93302311	10ft Y-Cable/Hook	
		93306699	15ft Y-Cable/Hook	
		93306750	20ft Y-Cable/Hook	

DIMENSIONS

Size	Length (A)	Width (B)	Height (C)
1X	14.2" (361mm)	9.9" (252mm)	2.0" (51mm)
2X	19.8" (503mm)	11.8" (300mm)	2.0" (51mm)

Bottom View

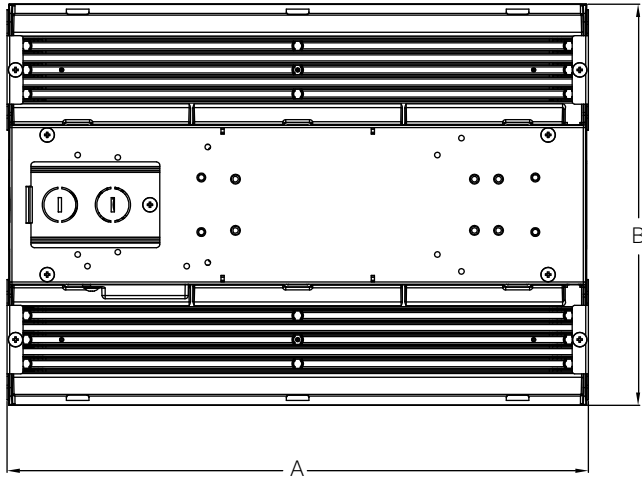

Top View

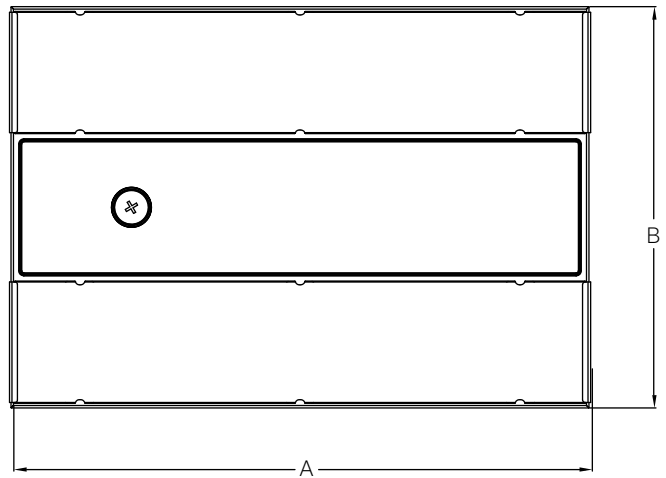

Side View

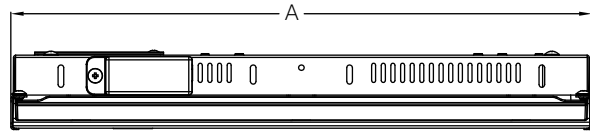

End View

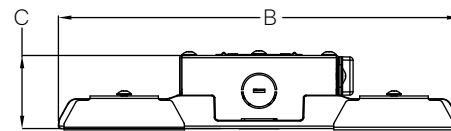

Sensor

0.74" (19mm)

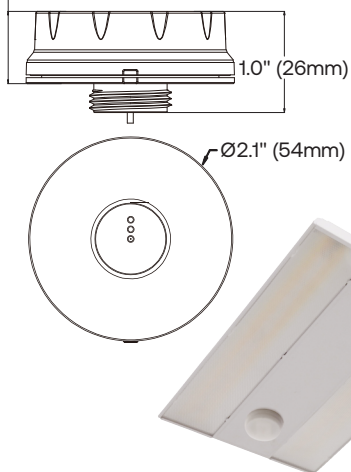

Coverage

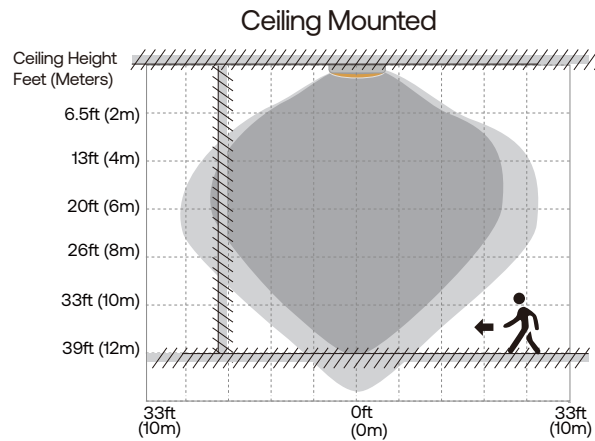

This figure indicates the maximum distance at the highest mounting height with 100% sensitivity

- Well Detected Area
- Possibly Detected Area



1.6 - 3 Ft/s
(0.5-1.0M/S)

PHOTOMETRIC DATA

PHB Size 1X

80 CRI

5000K

23962 LM

PHB1X08MDQVSTKQW

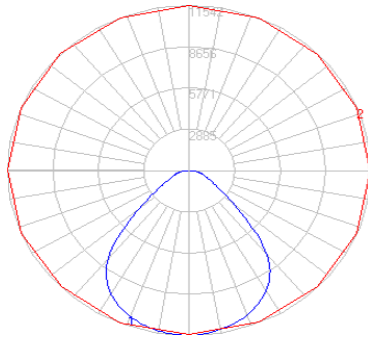

ZONE	LUMENS	% OF FIXTURE
0-30	9008.17	37.6
0-40	14586.16	60.9
0-60	21434.72	89.5
0-90	23961.99	100
0-180	23961.99	100

PHB Size 2X

80 CRI

5000K

34900 LM

PHB2X08MDQVSTKQW

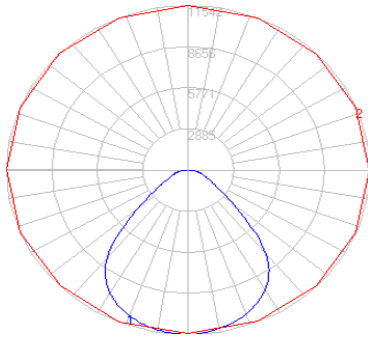

ZONE	LUMENS	% OF FIXTURE
0-30	13079.59	37.5
0-40	21082.85	60.4
0-60	31229.93	89.5
0-90	34899.74	100
0-180	34899.74	100

SENSOR SPECIFICATIONS

	Model NO.	HD07VR-PH-1	
PIR INFORMATION	Infrared Wavelength	5-14um	
	Output Signal Peak	≥3500mV	
	Installation Height	12m/39ft Max.	
	Detection Distance	≥3m/9ft	
	Warranty	3 Years	
SENSOR PARAMETER	Detection Area	25%/50%/75%/100%	
	Holdtime	5s/30s/1min/3min/5min/10min/20min/30min	
	Daylight Threshold	Disable/ 2lux/ 10lux/ 30lux/ 50lux/ 80lux/ 120lux	
	Standby Dimming Level	10%/20%/30%/50%	
	Standby Period	0s/10s/30s/1min/5min/10min/30min/60min+∞	
	Dusk/Dawn Sensing/ Photocell	Daylight threshold as 30lux/ 50lux/ 80lux/ 120lux	
		Standby period as +∞ ;	
		Standby dimming level as 10%/20%/30%	
	Default Program	Detection Area - 100%	
		Holdtime - 5S	
Daylight Threshold - disable			
Standby Period - 0S			
Standby Dimming Level - 10%			
Control	Standard Partner HD05R, the LCD screen display remote (purchase separately)		
INPUT	Input Range	12VDC	
	Voltage Range	10-15VDC	
	Current	≥30mA	
OUTPUT	Signal	DIM 0-10V	
	Connection	12VDC input/ Black&White wire; DIM+/ Purple wire; DIM-/ Pink wire	
	Stand-by Power	<30mA Power Consumption	
ENVIRONMENT	Working Temp	-20°C~+60°C	
	Storage Temp	-40°~+80° Humidity: 85% (non-condensation)	
CERTIFICATE & STANDARDS	Certification	UL (E529048)	
	Environmental Requirements	In accordance with CE ROHS	
	IP Rating	IP20	
PACKAGE	Silk-Printing	Lasering	
	Packing Description	1pcs/white neutral box	
	Qty/ctn (pcs)	120	
	Net Weight/pcs (kg)	0.05	
	Gross Weight/CTN (kg)	6.6	
	Carton Size (cm)	40*30*25	

SENSOR PERFORMANCE

Sensor Accessory is able to differentiate artificial light brightness from natural light after installed inside the fixture, and automatically turn off light when ambient brightness exceeds preset lux level

Precondition of Dusk/Dawn Function

1. Standby period is $+\infty$;
2. Standby dimming level is on 10%, 20% or 30%
3. Daylight threshold is on 30lux/ 50lux/ 80lux/ 120lux

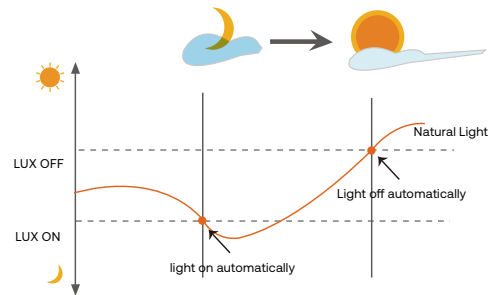

1. WITH DUSK/DAWN FUNCTION

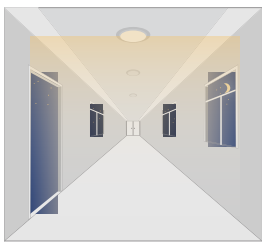

With insufficient ambient brightness, sensor turns on light and keeps it at standby dimming level even if there is no motion or presence.

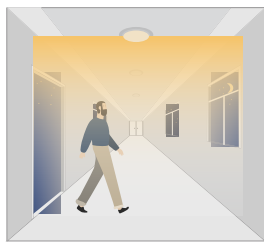

When sensor detects motion or presence it will bring light level up to 100%.

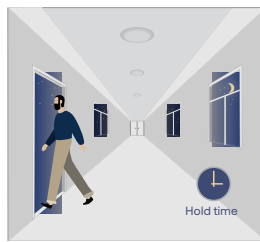

After Motion is no longer detected, fixture remains at 100% for hold time.

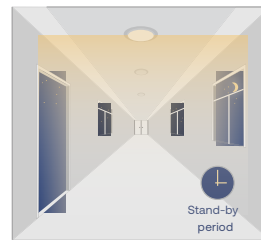

After pre-set hold time period it will dim light to standby dimming level again and always keep it

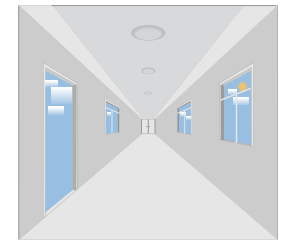

With Sufficient ambient brightness, sensor will turn OFF light automatically.

2. WITH DAYLIGHT DISABLED

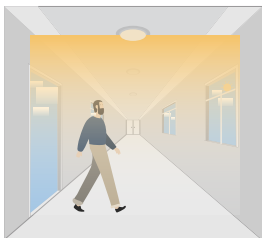

Sensor turns light ON when motion is detected

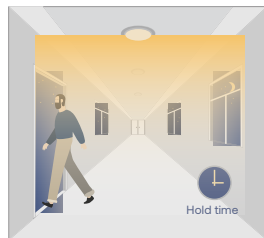

Sensor holds for a time period after motion leaves

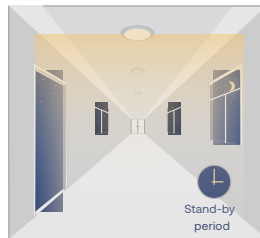

Sensor dims light to standby dimming level after hold time if there is still no motion

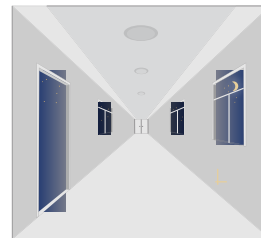

Sensor turns light OFF after standby period

2. WITH DAYLIGHT THRESHOLD

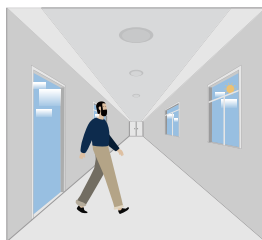

With sufficient daylight, the sensor keeps light OFF even if motion gets detected

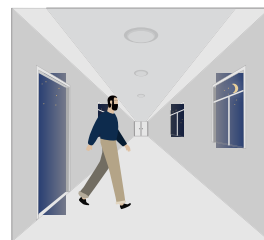

With insufficient daylight, the sensor turns light ON when motion gets detected

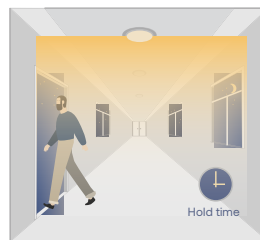

After there's no motion detected, the sensor keeps light ON 100% for holdtime.

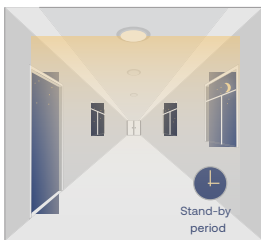

After holdtime, sensor dims light to standby dimming level for a standby period. If the standby period has been set to 0s, sensor turns light OFF automatically after holdtime.



The sensor turns OFF light automatically after the standby period when there's no motion detected