

# PS300 Series Electronic Transformer Specifications

## Model PS300-1224-T-B



### INPUT SPECIFICATIONS

- 
- 2.50 @ Full Load
- 
- 
- 

## Model PS300-1224-S-B

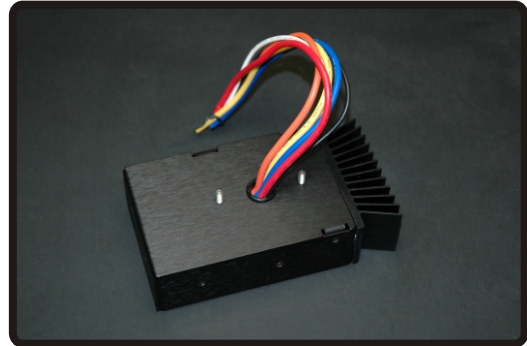

### OUTPUT SPECIFICATIONS

Applies to Models PS300-1224-T-B & PS300-1224-S-B

- Vac @ 120Vac Input 11.7Vac or 23.5Vac
- Frequency 20Khz +/-5%
- Min / Max. Load Rating 75W-300W 12V or 24V lamp
- Overload & Short Protected Auto-restart
- Output Voltage Limited See 'List of Features'
- Output distance limited to 5 feet

- Enclosure Overall Dimensions
- Unit Weight
- Minimum Operating Temperature
- Maximum Operating Temperature
- EMI / RFI Compliance
- Sound Rating
- UL / CUL Recognized

See Data Sheets for Enclosure Types  
18 oz.  
Min. Enclosure Temp -30°C  
Max. Enclosure Temp 80°C  
FCC Part 15  
Rated 'A'  
E134599

PS300-Series transformers have four different color output leads which can be wired in three different output configurations. When using option #3 the two 150VA 12V branch circuits need to be balanced. The sum of both branch circuits must not exceed 300Watts. If only a single 12V branch output is required, we recommend paralleling both 12V outputs as shown in wiring option #2 to minimize voltage drop.

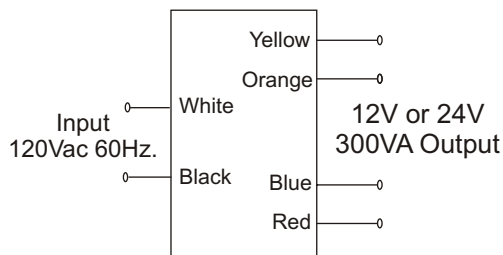

#### Output wiring option #1 (One 24V 300VA Branch)

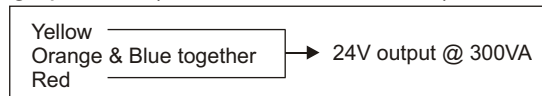

#### Output wiring option #2 (One 12V 300VA Branch)

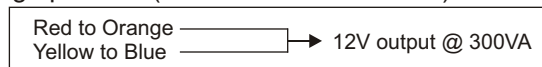

#### Output wiring option #3 (Two 12V 150VA Branches)

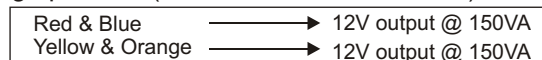

# PS300 Series Electronic Transformer Enclosure Configurations

## MODELS PS300-1224-T-B & PS300-1224-S-B

- |  |   |
|--|---|
| ● Material                                 | 0.063 Aluminum Alloy                          |
| ● Finish                                   | Line Grain Black Anodized                     |
| ● Input Wires (1 Wht, 1 Blk)               | UL1015 18 gauge stranded 105°C / 9" in length |
| ● Output Wires (Orange, Red, Blue, Yellow) | UL1015 12 gauge stranded 105°C / 9" in length |
| ● PS300-1224-T-B Mounting                  | 4pc's #8 Screw                                |
| ● PS300-1224-S-B Mounting                  | 8-32 x 0.375" S.S. Studs 2.0" on center       |

For best results Transformer should be mounted securely to a flat metallic surface .  
Maximum enclosure temperature not to exceed 80°C.

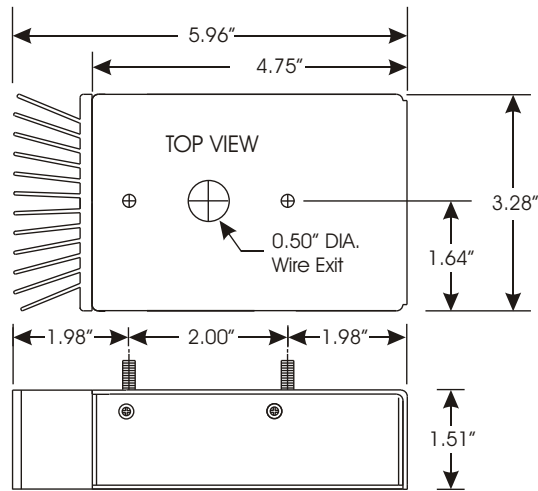
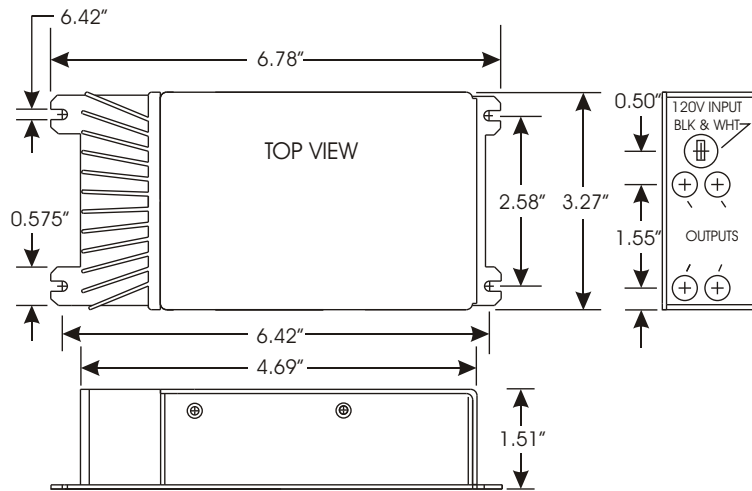

The PS300 Series Transformers feature an On-Board microprocessor which allows precision control of the features this product series possesses. Our Electronic transformers incorporate state of the art technologies placing them among the most technologically advanced electronic transformers on the market today.

**Short-Circuit** - Under a short circuit condition, the transformers output shuts down and begins to sample the output load periodically. Once the short condition has been corrected, the transformer automatically returns to a normal operating state. The transformer is under no stress during a short circuit and can maintain this indefinitely without damage or undue stress to the components. Upon removal of the short, the unit will again soft start and ramp up to a normal output voltage level.

This transformer also complies with the latest UL proposed shut down requirements for uninsulated bus bar systems.

**Output Connections** - The PS300 Series AC transformer has the option of a 12V or 24V output. (See notes)

**Overload Protection** -At load levels >350watts the output over current will engage and the unit will cycle ON & OFF at a rapid rate until the overload has been corrected.

**Soft Lamp Start** - When power is applied to the transformer, the microprocessor comes up first taking control and gently ramping the output voltage up to the designed level.

**Inrush Current** - Because of the precision transformer control there is no inrush current. Current control begins from the start of the first line cycle when power is first applied. Typical soft start approaches used with most self oscillating type half and full bridge circuit topologies do not catch the first couple of line cycles. The first line cycle is where the highest inrush current is present and thus the most damaging. PSI's cycle by cycle control approach reduces this undue stress on branch circuit breakers as well as to the internal components within the transformer. This will also aid in increasing lamp life.

<b>Load</b>	<b>12V Regulation @ 120Vac IN</b>	<b>24V Regulation @ 120Vac IN</b>
50W	<12.1	<24.2
100W	<12.1	<24.2
150W	<12.0	<24.0
200W	11.9	23.8
250W	11.8	23.6
300W	11.7	23.4

**Dimming** - Dimming is achieved using most quality line dimmers. The output of the dimmer can be a true sinewave to a phase controlled (Triac) type. Once the output of the dimmer reaches <35V RMS, the transformer merely turns itself off. Increasing the dimmer voltage back up will allow the unit to automatically restart itself. The dimmer must be in a (full-on) position for the transformer to initially start.

**Mounting** - This product is offered in two mounting configurations. The Stud mount is a bottom feed in which two 8-32 x 3/8" Studs are located on 2.0" centers with the lead wires exiting through a 1/2" O.D. hole between the studs.

The Surface mount or (end feed) configuration has four feet located on each of the four corners of the enclosure with 'U' shaped slots that will accept #6 or #8 screws. See specification sheet for exact dimensions on both configurations.