



- Compatible Control Systems
 - Lutron EcoSystem Digital Control – dims down to 1%
 - Lutron 3-Wire Phase Control – dims down to 1%
 - Lutron DALI Digital – dims down to 1%
 - 0-10V – dims down to 5%
 - Line Voltage Dimming (LVD) – 5% (120V only for dimming)
- Simplest & safest option for substantial maintenance and energy savings
- Keep existing fixtures, sensors, and control system—no mess, no fixture recycling, and no need to break the ceiling plane
- Retrofit for over 50% less than installing a new fixture
- Optimize local utility rebates
- 32W & 42W horizontal kits may not fit in all 6-inch cans—test for fit
- Not for use in enclosed fixtures



G24Q 4-PIN BASE
(NOT INTENDED TO REPLACE 2-PIN G23 OR GX23 2-PIN LAMPS)



OMNI



25W VERTICAL



12W VERTICAL



HORIZONTAL



5
YEAR
WARRANTY



120-277V
EXT DRIVER / LVD =120V DIMMING ONLY



0-10V
DIMMING DIMS DOWN TO 5%



LUTRON ECOSYSTEM & 3-WIRE



TYPE C RETROFIT



PWR FACTOR
>90



CRI
80+



OPERATING TEMP
32°F TO 104°F

ETL CLASSIFIED



HEADQUARTERS & TRAINING CENTER • Cary, IL | INNOVATION & MANUFACTURING CENTER • Middleton, MA

847.380.3540 • led-llc.com • sales@led-llc.com

10.13.25 Information is subject to change without notice.

Light Efficient Design.



PART NUMBER BUILDER

MFR	TYPE	LUMINAIRE CONFIGURATION	# OF LAMPS	CCT	CONTROL INTERFACE	CASE	GEN	OPTIONS
RP	G24Q						G2	
		126V 126H	1L	830 = 3000K	E1 = LUTRON ECO SYSTEM (DIMS DOWN TO 1%)	K = SQUARE W/ STUDS (NOT FOR USE W/ LVD 132V OR 132H CONFIGURATIONS)		-EMG -TAA
		132V 132H	2L	835 = 3500K	3W = LUTRON 3-WIRE (DIMS DOWN TO 1%)			SEE TABLE BELOW
		142V 142H		840 = 4000K	DA = DALI DIGITAL (DIMS DOWN TO 1%)	KN = SQUARE W/O STUDS		
		226V 226H			10V = 0-10V DIMMING (DIMS DOWN TO 5%)	M = LINEAR (NOT FOR USE W/ LVD 132V OR 132H CONFIGURATIONS)		
		232H			LVD = LINE VOLTAGE DIMMING (5% DIMMING TYPICAL. 120V/277V SWITCHED; 120V ONLY FOR DIMMING)	(SEE DIMENSIONS ON PG. 3)		
		242H						

EXAMPLE PART NUMBER RP-G24Q-126V-1L-830-3W-K-G2-EMG-B-AA

OPTIONS

EMG	TAA
EMERGENCY BATTERY BACKUP (See page 4 for more details)	TAA=CONTACT US FOR OPTIONS

CFLS CAN BE MOUNTED HORIZONTALLY OR VERTICALLY IN MANY FIXTURE TYPES*

EXISTING	1L VERT 26W	1L VERT 32W	1L VERT 42W	2L VERT 26W	1L HORIZ 26W	1L HORIZ 32W	1L HORIZ 42W	2L HORIZ 26W	2L HORIZ 2x 32W	2L HORIZ 2x 42W
KIT PART #**	RP-G24Q-126V-1L-8XX-DD-C-G2	RP-G24Q-132V-1L-8XX-DD-C-G2	RP-G24Q-142V-1L-8XX-DD-C-G2	RP-G24Q-226V-2L-8XX-DD-C-G2	RP-G24Q-126H-1L-8XX-DD-C-G2	RP-G24Q-132H-1L-8XX-DD-C-G2	RP-G24Q-142H-1L-8XX-DD-C-G2	RP-G24Q-226H-2L-8XX-DD-C-G2	RP-G24Q-232H-1L-8XX-DD-C-G2	RP-G24Q-242H-1L-8XX-DD-C-G2
LAMP TYPE	OMNI	DIRECTIONAL	DIRECTIONAL	OMNI	DIRECTIONAL	DIRECTIONAL	DIRECTIONAL	DIRECTIONAL	NONE	DIRECTIONAL
KIT WATTAGE	12W	14W	28W	24W	13W	14W	21W	26W	24W	28W
KIT LUMENS	900	1200	2700	1800	1000	1200	2000	2000	2400	2700
LAMP DIMENSIONS	6.8" x 1.3"	3.0" x 3.8"	4.2" x 3.7"	6.8" x 1.3"	5.8" x 1.4"	3.0" x 3.8"	4.2" x 3.7"	5.8" x 1.4"	3.0" x 3.8"	4.2" X 3.7"
INCLUDED ADAPTER	NONE	NONE	NONE	NONE	NONE	7317	7317	NONE	7317	7317
OPTIONAL EXTENDER	N/A	7319	7319	N/A	N/A	N/A	N/A	N/A	N/A	N/A



* SINCE LUMINAIRE DESIGNS VARY BY MANUFACTURER AND MODEL, A MOCK UP IS SUGGESTED TO CONFIRM FIT (SEE PG. 4 FOR COMMON FIXTURE TYPES)

** SEE PART NUMBER BUILDER FOR FINAL PART NUMBERS



DRIVER DIMENSIONS

LUTRON



CASE TYPE K

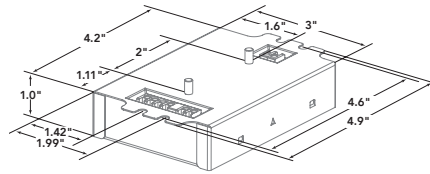

K CASE CONNECTOR LOCATIONS (WITH STUDS)

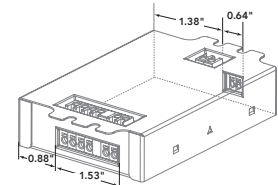

KN CASE SIDE ENTRY CONNECTOR LOCATIONS (WITHOUT STUDS)



CASE TYPE M

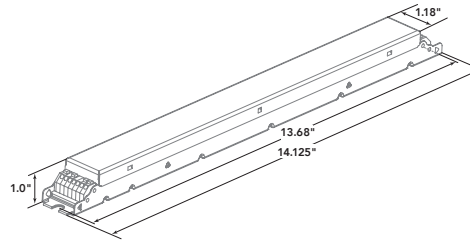

LVD



M CASE

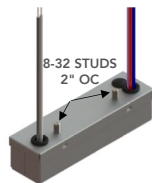

K CASE

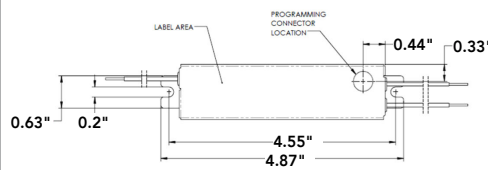

M CASE

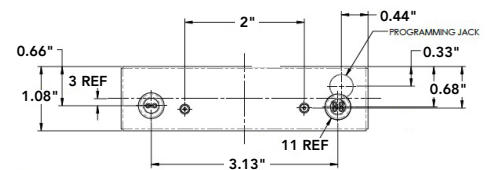

K CASE



KN CASE
25W SYSTEM MAX



KN CASE
26W-60W SYSTEM MAX

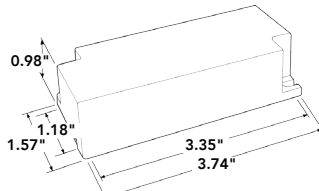

KN CASE 25W SYSTEM MAX

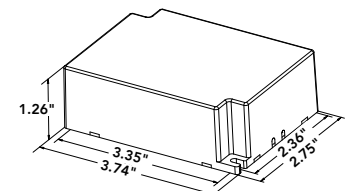

KN CASE 26W-60W SYSTEM WATTAGE

NOTE IT IS IMPORTANT THAT LVD DRIVERS ARE MOUNTED TO A FLAT SURFACE IN ORDER TO MAXIMIZE SERVICE LIFE

10V

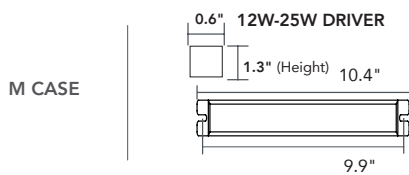

M CASE

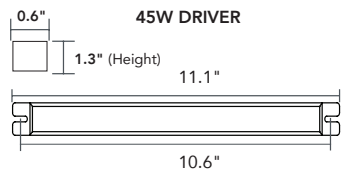

45W DRIVER

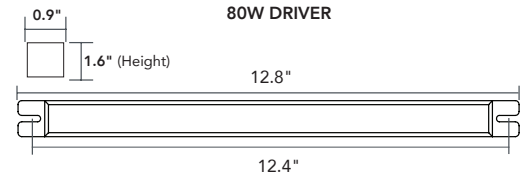

80W DRIVER

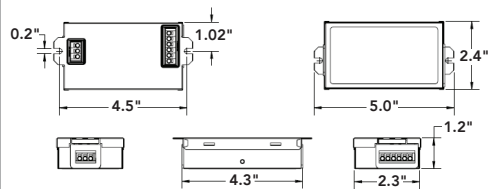

KN CASE

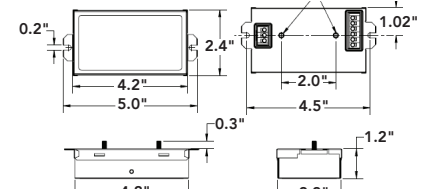

K CASE



EMG CONFIGURATIONS

4W ALL-IN-ONE EMG

LINE DRAWING

EXISTING G24Q LAMPS WILL LIGHT IN EMG MODE
 Approximately 500 lumens for 90 minutes.
 Contact us for more options

DRIVER



EMG DIMENSIONS: 5.34" x 1.69" x 1.01"
 SEE BELOW FOR WIRING DIAGRAM

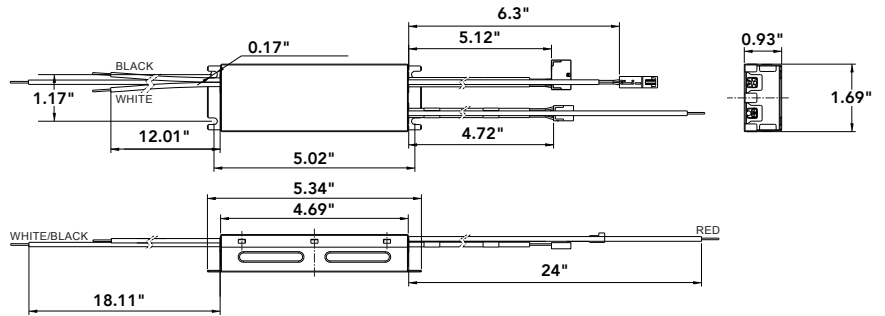

WIRING DIAGRAM

4W ALL-IN-ONE EMG

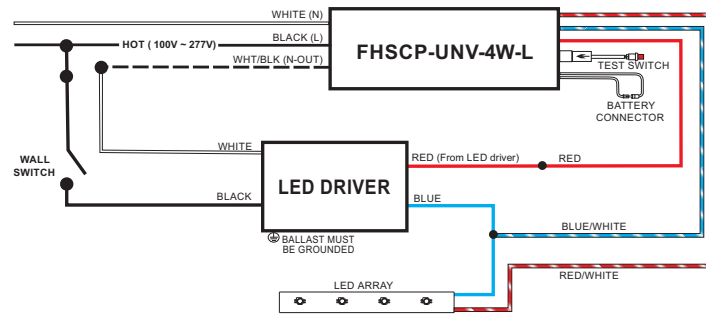

MOST COMMON FIXTURE TYPES

HORIZONTAL



2-LAMP DOWNLIGHT ORIENTATION

VERTICAL



1-LAMP DOWNLIGHT ORIENTATION

PENDANT



1 OR 2-LAMP UPLIGHT/DOWNLIGHT ORIENTATION

SCONCE



1 OR 2-LAMP VERTICAL ORIENTATION



FOR MORE INFORMATION VISIT C-FLEXRETROFITS.COM OR CONTACT US