



PART # \_\_\_\_\_

JOB NAME \_\_\_\_\_

TYPE \_\_\_\_\_



RemPhos' LBE (LEDBARKIT External-Drive) universal retrofit kit for linear fluorescent luminaires is the perfect retrofit solution. Designed to easily fit into existing T5/T8/T12 linear fluorescent fixtures. Fast, one-person installation.

- **Simple installation.** Convert existing fixtures fast with magnets on the back of the light bars that allow hands-free placement (self-drilling screws are pre-captivated on each magnetic bracket for fast & secure install). Electrical quick connects for simple, error-free power connections.
- **Fits between the sockets.** No need to remove existing T5/T8/T12 sockets. The LEDBAR is sized to fit in between the existing sockets, further reducing install time.
- **Maximum versatility.** Standard lengths along with multiple lamp/driver combinations (1L,2L,3L,4L) provides a fit for any application.
- **Many light output choices.** Systems available from 6W (800LM) all the way to 80W (13,000LM). Standard 10V drivers now include FlexWatt that allows you to chose the exact lumen/wattage package needed. See ordering guide for available lumen packages.
- **Custom bracket designs available.** Stream line your retrofit project with custom professional brackets to reduce install time and variation of install.
- **Simple & Network Lighting Controls** options available (see pg. 2 & 13-18)



**FLEXWATT** SWITCH BETWEEN  
4 WATTAGES



120-277V\*  
\*120-347V FOR CANADA ONLY

167 LPW  
EFFICACY

<15% THD  
>0.9 PWR FACTOR

80+  
CRI (UNLESS NOTED)

0-10V  
DIM TO OFF 12V AUX

OCC

120°  
BEAM ANGLE

EMG  
OPTIONAL EMG BATTERY BACKUP

-4°F TO 122°F  
OPERATING TEMP

L70  
100,000hrs RATED LIFE



**LENGTH**  
 1FT = 10.2"  
 2FT = 21.65"  
 3FT = 34.25"  
 4FT = 44.37"

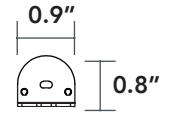
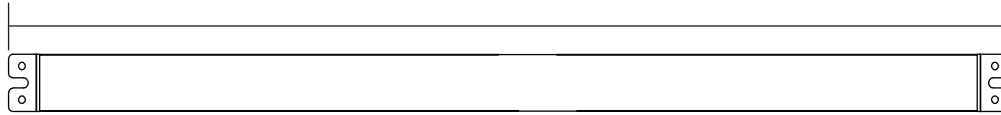

**PART NUMBER BUILDER - SEE PG. 3 FOR ORDERING DIRECTIONS**

MFR	PRODUCT	GENERATION	WATTAGE	LENGTH	# OF LAMPS	COLOR	DIMMING	OPTIONS
RP	LBE	G2				8XX		
			6 8 10 12 15 18 20 25 30 35 40 45 50 60 70 80	1FT 2FT 3FT 4FT	1L 2L 3L 4L	8=80+ CRI XX=CCT 30=3000K 35=3500K 40=4000K 50=5000K	10V LVD 1 STEP 2 STEP	HV (120-347V) AA (ARRA SECTION 1605)

**EXAMPLE PART NUMBER**

RP-LBE-G2-6W-1FT-1L-840-10V-AA

Emergency battery backup options ordered separately. See pages 12-15 for more information.

**CONTROL OPTIONS**

SIMPLE LIGHTING CONTROL		NETWORK LIGHTING CONTROL			
<b>RC-OCC-HNS111-A</b> MICROWAVE OCCUPANCY SENSOR IR12 REMOTE	<b>RC-OCLR-HNS111LR-A</b> LIMITED RANGE MICROWAVE OCCUPANCY SENSOR IR12 REMOTE	<b>RC-OMWBT-MW-7-BLE-SR</b> SILVAIR LONG RANGE MICROWAVE SENSOR SILVAIR APP	<b>RC-OCCBT-HNB131PIR</b> CONTROL NODE + MICROWAVE MOTION & DAYLIGHT SENSOR SILVAIR APP	<b>RC-BT-HNB131CTL</b> SILVAIR BLUETOOTH NODE SILVAIR APP	<b>RC-BTX-HNB136</b> SILVAIR BLUETOOTH EXTERNAL ANTENNA SILVAIR APP



Light Efficient Design/RemPhos has partnered with Silvaire to offer a wireless Bluetooth-mesh eco-system fixture integral control. Silvaire is listed on the DLC NLC certified to Technical Requirements Version 5.1. Our Silvaire controls meet all eligibility criteria of integral, fixture-mounted, addressable sensors with motion and photocell/ambient light-sensing capabilities along with embedded programming that can be configured and networked. System to control motion response, illumination levels, and scheduling.

**ORDERING DIRECTIONS (SEE ORDERING GUIDE ON NEXT PAGE)**

- A) Choose your desired total system wattage and lumen output.
- B) Choose your desired LEDBAR length (1,2, 3 or 4FT) and QTY of LEDBAR(s) per driver from column C.
- D) Order system part # (a system will include 1pc LED driver + LEDBAR(s). Substitute "XX" in the 8XX for your desired CCT. 30 (3000K), 35 (3500K), 40 (4000K) and 50 (5000K) are standard color temps. 27 (2700K), 65 (6500K) are custom colors and are special order.
- E) The wattage of each LEDBAR in the system.
- F) The lumen output of each LEDBAR in the system.

**If the system you want is not currently a listed part #, please contact us for a letter to send to your Utility for custom incentive approval.**

**CAUTION! MAX WATTAGES PER LEDBAR**  
 1FT: 7.5W 2FT: 12.5W 3FT: 12.5W 4FT: 25W



PART #	WATTAGE	BARS PER DRIVER	BAR LENGTH	BAR LUMENS	DLC CATEGORY	3500K	4000K	5000K
RP-LBE-G2-6W-1FT-1L-8XX-10V	6W	1	1FT	930				
RP-LBE-G2-6W-1FT-2L-8XX-10V		2	1FT	900				
RP-LBE-G2-6W-2FT-1L-8XX-10V		1	2FT	936	Linear Ambient	PRB3E2VH	PX817GIG	PHGDUW8H
RP-LBE-G2-6W-3FT-1L-8XX-10V		1	3FT	894	Linear Ambient	P1Q3OPXM	PP924MAB	PBNZQWRK
RP-LBE-G2-6W-4FT-1L-8XX-10V		1	4FT	756	Linear Ambient	P8R5JB3E	P5QXPXX0	PSW5EGIT
RP-LBE-G2-8W-1FT-1L-8XX-10V	8W	1	1FT	1240				
RP-LBE-G2-8W-1FT-2L-8XX-10V		2	1FT	1190				
RP-LBE-G2-8W-2FT-1L-8XX-10V		1	2FT	1288	Linear Ambient	P62A55CE	PVJA0P94	PQE7OFFV
RP-LBE-G2-8W-3FT-1L-8XX-10V		1	3FT	1264	Linear Ambient	PECHEP2F	PE3U62N3	P52S5K5C
RP-LBE-G2-8W-4FT-1L-8XX-10V		1	4FT	1232	Linear Ambient	PQV4C8WI	PENZ5M00	PHDXFH50
RP-LBE-G2-10W-1FT-2L-8XX-10V	10W	2	1FT	1550				
RP-LBE-G2-10W-1FT-3L-8XX-10V		3	1FT	1488				
RP-LBE-G2-10W-2FT-1L-8XX-10V		1	2FT	1640	Linear Ambient	PAG1QYAT	PS05KCWZ	PON4R76H
RP-LBE-G2-10W-2FT-2L-8XX-10V		2	2FT	1440				
RP-LBE-G2-10W-2FT-3L-8XX-10V		3	2FT	1162				
RP-LBE-G2-10W-3FT-1L-8XX-10V		1	3FT	1640	Linear Ambient	PO7JATAZ	PQSXHIOL	P9Y4IPU5
RP-LBE-G2-10W-4FT-1L-8XX-10V		1	4FT	1630	Linear Ambient	PUPFZA3E	P7M0BTFL	P1JE9JZ6
RP-LBE-G2-12W-1FT-2L-8XX-10V	12W	2	1FT	1860				
RP-LBE-G2-12W-1FT-3L-8XX-10V		3	1FT	1786				
RP-LBE-G2-12W-2FT-1L-8XX-10V		1	2FT	1968	Linear Ambient	PLQ8PMUV	P44M01CD	PJDFP97Z
RP-LBE-G2-12W-2FT-2L-8XX-10V		2	2FT	1728				
RP-LBE-G2-12W-2FT-3L-8XX-10V		3	2FT	1728				
RP-LBE-G2-12W-3FT-1L-8XX-10V		1	3FT	1992	Linear Ambient	POD0UQWQ	P8NS0WEQ	PYMKCGPJ
RP-LBE-G2-12W-3FT-2L-8XX-10V		2	3FT	1788				
RP-LBE-G2-12W-4FT-1L-8XX-10V		1	4FT	1956	Linear Ambient	PTM4M6BO	PLLHCS0Y	PZ8N20Q3
RP-LBE-G2-12W-4FT-2L-8XX-10V		2	4FT	1848				
RP-LBE-G2-15W-1FT-2L-8XX-10V	15W	2	1FT	2325				
RP-LBE-G2-15W-1FT-3L-8XX-10V		3	1FT	2232				
RP-LBE-G2-15W-2FT-2L-8XX-10V		2	2FT	2340				
RP-LBE-G2-15W-2FT-3L-8XX-10V		3	2FT	2160	Troffer	PGFMWM4H	PXBV2E1D	PACQE8VC
RP-LBE-G2-15W-3FT-1L-8XX-10V		1	3FT	2505	Troffer	PTSOZL8L	PSC036CO	PGQ7VD51
RP-LBE-G2-15W-3FT-2L-8XX-10V		2	3FT	2370				
RP-LBE-G2-15W-3FT-3L-8XX-10V		3	3FT	2235				
RP-LBE-G2-15W-4FT-1L-8XX-10V		1	4FT	2505	Linear Ambient	PFBAB42G	P95LQPN8	P4IB866H
RP-LBE-G2-15W-4FT-2L-8XX-10V		2	4FT	2310	Troffer	P3TJZNK0	P2HEA375	PPCNUKDM
RP-LBE-G2-18W-1FT-3L-8XX-10V	18W	3	1FT	2790				
RP-LBE-G2-18W-1FT-4L-8XX-10V		4	1FT	2678				
RP-LBE-G2-18W-2FT-2L-8XX-10V		2	2FT	2898	Troffer	P2Y1B1X1	PUPC18ML	PB45RQR6
RP-LBE-G2-18W-2FT-3L-8XX-10V		3	2FT	2592	Troffer	PKPOHC8J	PRJQYIEJ	PO95X3X8
RP-LBE-G2-18W-2FT-4L-8XX-10V		4	2FT	2592				
RP-LBE-G2-18W-3FT-2L-8XX-10V		2	3FT	2844				
RP-LBE-G2-18W-3FT-3L-8XX-10V		3	3FT	2682				
RP-LBE-G2-18W-3FT-4L-8XX-10V		4	3FT	2682				
RP-LBE-G2-18W-4FT-1L-8XX-10V		1	4FT	3024	Linear Ambient	PAYNDYTS	PHFUO1IL	PEF3GEG2
RP-LBE-G2-18W-4FT-2L-8XX-10V		2	4FT	2934	Troffer	P2JDXCOG	PC86OTIW	P9JWLLPC
RP-LBE-G2-18W-4FT-3L-8XX-10V		3	4FT	2772	Troffer	PZCC33MV	PZ35A5M2	PHF5RB7K
RP-LBE-G2-20W-1FT-3L-8XX-10V	20W	3	1FT	3100				
RP-LBE-G2-20W-1FT-4L-8XX-10V		4	1FT	2976				
RP-LBE-G2-20W-2FT-2L-8XX-10V		2	2FT	3220	Troffer	PBKQL1GY	PZA4UKKG	PUZ55K88
RP-LBE-G2-20W-2FT-3L-8XX-10V		3	2FT	2880	Troffer	P8LQ5KD0	PZTA6GYH	PX49U54Z
RP-LBE-G2-20W-2FT-4L-8XX-10V		4	2FT	2880				
RP-LBE-G2-20W-3FT-2L-8XX-10V		2	3FT	3280				
RP-LBE-G2-20W-3FT-3L-8XX-10V		3	3FT	3160				
RP-LBE-G2-20W-3FT-4L-8XX-10V		4	3FT	3160				
RP-LBE-G2-20W-4FT-1L-8XX-10V		1	4FT	3360	Linear Ambient	PLYHZD1Z	P3U4EIAF	P8NNERJ7
RP-LBE-G2-20W-4FT-2L-8XX-10V		2	4FT	3260	Troffer	P9IB4W7O	POK6M2XP	PH9386HN
RP-LBE-G2-20W-4FT-3L-8XX-10V		3	4FT	3080	Troffer	PLOSOXVE	PL4ZAMLI	PXBW8K6S



PART #	WATTAGE	BARS PER DRIVER	BAR LENGTH	BAR LUMENS	DLC CATEGORY	3500K	4000K	5000K
RP-LBE-G2-25W-1FT-4L-8XX-10V	25W	4	1FT	3875				
RP-LBE-G2-25W-2FT-2L-8XX-10V		2	2FT	4100	Troffer	PMDC3DLY	PKL6SFJP	PSQD1UTC
RP-LBE-G2-25W-2FT-3L-8XX-10V		3	2FT	4025	Troffer	PQUGP3E1	P6RV8JX4	PDPD6MP2
RP-LBE-G2-25W-2FT-4L-8XX-10V		4	2FT	3900				
RP-LBE-G2-25W-3FT-3L-8XX-10V		3	3FT	4100				
RP-LBE-G2-25W-3FT-4L-8XX-10V		4	3FT	3950				
RP-LBE-G2-25W-4FT-1L-8XX-10V		1	4FT	4175	Linear Ambient	POJBJTPC	PR17YM6C	PW9U36FX
RP-LBE-G2-25W-4FT-2L-8XX-10V		2	4FT	4175	Troffer	PNVYU5CC	PHS92SIE	PY4COSG4
RP-LBE-G2-25W-4FT-3L-8XX-10V		3	4FT	3850	Troffer	P3MWG6MS	PSE0GEDN	PA60KY3D
RP-LBE-G2-25W-4FT-4L-8XX-10V		4	4FT	3850				
RP-LBE-G2-30W-2FT-3L-8XX-10V	30W	3	2FT	4920	Troffer	PM44IVJJ	P3A4HYT7	P5USDXGC
RP-LBE-G2-30W-2FT-4L-8XX-10V		4	2FT	4830				
RP-LBE-G2-30W-3FT-3L-8XX-10V		3	3FT	4980				
RP-LBE-G2-30W-3FT-4L-8XX-10V		4	3FT	4740				
RP-LBE-G2-30W-4FT-2L-8XX-10V		2	4FT	5040	Troffer	PQI4QKFX	PWS00OZ8	P3RAZEDK
RP-LBE-G2-30W-4FT-3L-8XX-10V		3	4FT	4890	Troffer	PZ1WEY9T	PC8JJOIQ	PJ0GHEND
RP-LBE-G2-30W-4FT-4L-8XX-10V		4	4FT	4620	Troffer	P43S4ILF	P4WSD7GG	PBYLVMZ2
RP-LBE-G2-35W-2FT-3L-8XX-10V	35W	3	2FT	5740	Troffer	PE0YFJMK	P00MVBYS	PDT0BYAZ
RP-LBE-G2-35W-2FT-4L-8XX-10V		4	2FT	5635				
RP-LBE-G2-35W-3FT-3L-8XX-10V		3	3FT	5810				
RP-LBE-G2-35W-3FT-4L-8XX-10V		4	3FT	5740				
RP-LBE-G2-35W-4FT-2L-8XX-10V		2	4FT	5880	Troffer	PCEAYOLH	PHHJJ7Q7	PO5E8UIB
RP-LBE-G2-35W-4FT-3L-8XX-10V		3	4FT	5705	Troffer	PI206DOG	PA221SYC	PREJ56PF
RP-LBE-G2-35W-4FT-4L-8XX-10V		4	4FT	5390	Troffer	PRNA6ERF	PHRLQ6NW	PLGQOQSHD
RP-LBE-G2-40W-2FT-4L-8XX-10V	40W	4	2FT	6560				
RP-LBE-G2-40W-3FT-4L-8XX-10V		4	3FT	6560				
RP-LBE-G2-40W-4FT-2L-8XX-10V		2	4FT	6680	Troffer	PSAJ16B6	PIVIEP1	PFE9LAKI
RP-LBE-G2-40W-4FT-3L-8XX-10V		3	4FT	6680	Troffer	PJO5URF7	PNO08S2C	P4LWQKGI
RP-LBE-G2-40W-4FT-4L-8XX-10V		4	4FT	6520	Troffer	PMUONBP2	P3IMKH82	P5DSYCK7
RP-LBE-G2-45W-2FT-4L-8XX-10V	45W	4	2FT	7380				
RP-LBE-G2-45W-3FT-4L-8XX-10V		4	3FT	7470				
RP-LBE-G2-45W-4FT-2L-8XX-10V		2	4FT	7425	Troffer	P29BQ4XQ	PCGLIANA	P9AGK00M
RP-LBE-G2-45W-4FT-3L-8XX-10V		3	4FT	7515	Troffer	P8K4KU9Y	P6Y6FQN6	PBM805KP
RP-LBE-G2-45W-4FT-4L-8XX-10V		4	4FT	7335	Troffer	PZQKU0RR	PH63ZGAD	PRISOQAK
RP-LBE-G2-50W-4FT-2L-8XX-10V	50W	2	4FT	8200				
RP-LBE-G2-50W-4FT-3L-8XX-10V		3	4FT	8400	Troffer	PSCL7TGG	PK9A6WJM	PGZMX0RE
RP-LBE-G2-50W-4FT-4L-8XX-10V		4	4FT	8400	Troffer	PXY07A81	P0EJEM2B	POR8NUEX
RP-LBE-G2-60W-4FT-3L-8XX-10V	60W	3	4FT	10,080	Troffer	PBEJYDS6	PO6P4ODV	P6YFJD6J
RP-LBE-G2-60W-4FT-4L-8XX-10V		4	4FT	10,080	Troffer	P2EUH4QA	P1AAKG4I	P15S9LRA
RP-LBE-G2-70W-4FT-3L-8XX-10V	70W	3	4FT	11,690	Troffer	P3HKNSD8	PMA24C2C	PDAXW1RS
RP-LBE-G2-70W-4FT-4L-8XX-10V		4	4FT	11,760	Troffer	P7LFRT4B	PKSZD1GX	POR0U83M
RP-LBE-G2-80W-4FT-4L-8XX-10V	80W	4	4FT	13,360	Troffer	PRPYODKD	PPW0IQ1S	PNCRDNHD



## WHY USE THE LBE?

**MORE EFFICIENT** because the higher efficiency optics, LEDs and drivers we use provide higher lumens per watt and less wattage compared to LED tubes.

**MORE RELIABLE** because of the significant amount of aluminum that we use as a heat sink on the back of the LEDBAR properly dissipates the heat and keeps the electronics cooler than LED tubes.

**MORE UNIVERSAL FIT** because our bars are designed to fit in between the sockets of either T5 or T8 fixtures. That means you can specify a 4ft LEDBAR for any T5 or T8 style fixture whether it is a troffer, vapor tight, a pendant, a strip or many other applications.

**LESS LIABILITY** because you will be getting rid of the old fluorescent tube sockets that often can lead to future issues such as arcing, early failure or even a fire.

**BETTER PIECE OF MIND** because the LEDBARKIT family comes standard with a 10-year system warranty. **By purchasing the LEDBARKIT SYTRM, Remphos/Light Efficient Design provides a single, easy point of contact for the system warranty.**

## MORE INFO

### HIGHER OUTPUT TO MATCH T5HO

Previous generation could only be powered up to 20W for the 4ft bar. G2 can be powered at up to 25W for the 4ft bar to match the foot candles of a T5HO FL lamp. All light bars are over 150LPW, with AC wall efficiencies including the driver from 130-145LPW.

### SINGLE CCT AVAILABLE

4FT: 25W Max, 3FT: 12W Max, 2FT: 12W Max, 1FT: 8W Max

### FLEXWATT STANDARD

Each driver has 4 adjustable wattage choices. With FlexWatt, there are now significantly more wattage choices to allow you to select exactly what lumen/wattage package is needed to maximize energy savings.

### DIM-TO-OFF SENSOR READY DRIVERS STANDARD

12V auxiliary power and 10V dimming wires are standard in every kit. Allows for easy interface with dimming switches and control systems.

### VARIOUS CONTINUOUS AND STEP-DIM DRIVER OPTIONS.

We want to help you choose the lowest cost, easiest to implement method to dim our retrofit kits. While low voltage 10V dimming is a great approach, often it requires running new wiring. Therefore, we have line voltage phase dimming driver options, 2-switch step-dim driver options (to work with existing inbound/outbound wall switches), and 1-switch step-dim driver options (using 1 existing wall switch change brightness between pre-selected levels of 50%/100% for example).

### LESS WATTS TO REPLACE YOUR FLUORESCENT LAMPS

Previously G1 was 10W to replace 32W T8 FL, now with G2 10W or even 8W can be used for deeper energy savings. ordering guide for available systems.

### METAL, LINEAR BALLAST SHAPED LED DRIVERS

Previous G1 were plastic cases. New G2 are rigid metal cases, rugged and easy to mount. Thinner height to fit into even the most compact existing ballast compartments..

### REMOVABLE, ADJUSTABLE METAL MAGNETIC MOUNTING BRACKETS

Previous G1 had plastic end caps which accepted self-drilling screws and fixed magnets. G2 has an innovative bracket that can be slid anywhere on the bar, so that the screws can be mounted in various places depending on what is fastest/easiest for the install.

### LOWER COST EMERGENCY BATTERY BACKUP

### VARIOUS BRACKETS AVAILABLE FROM OUR "CUSTOM-SHOP"

Have a direct/indirect pendant hung fixture and want a fast way to mount bars pointing up and down? No problem, we have a solution. Have a wide-body vapor tight where you want 6 bars mounted together along with a motion sensor on a single pan? No problem, we have a solution. Let our engineers help design a bracket/mounting system that makes installation faster and easier for you.



## OPTIONAL MOUNTING BRACKETS - ORDERED SEPARATELY (SOLD IN PACKS OF 10)

Used when mounting to an uneven fixture surface or to match heights to driver channel when de-lamping

### SHORT BRIDGE

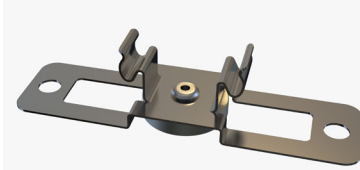

RP-LBE-G1-SHORTBRIDGE-10P

### TALL BRIDGE



RP-LBE-G1-TALLBRIDGE-10P

### SHORT BRIDGE

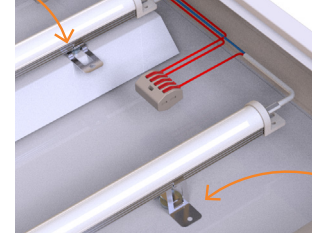

TALL BRIDGE

## OPTIONAL EMERGENCY BACKUP

A simple, effective solution when battery backup functionality is required. 500 lumen, 90-minute standard; specify EMG suffix in part number. Contact us for other backup times and lumen packages.



Wiring Diagram (TYP)

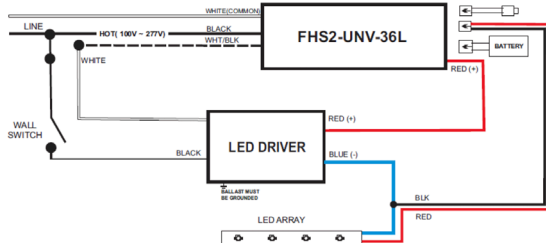

## KEY PRODUCT INFORMATION

- SIMPLE INSTALLATION
- FITS BETWEEN THE SOCKETS
- MAXIMUM VERSATILITY
- MANY LIGHT OUTPUT CHOICES
- CONTROL READY 10V DIMMABLE DRIVER
- SUITABLE FOR DRY & DAMP LOCATIONS
- UL 1598C CLASSIFIED RETROFIT KIT LISTED & PERFORMANCE QPL LISTED
- 10 YEAR WARRANTY, L70 >100,000HRS
- OPTIONAL "BAA" (ARRA SECTION 1605) BUY AMERICA ACT
- CUSTOM RETROFIT SOLUTIONS AVAILABLE
- OPTIONAL MOTION SENSOR/CONTROL READY





## SPECIFICATION GUIDE

MODEL	RP-LBE-G2-DRV-12W	RP-LBE-G2-DRV-12W-HV	RP-LBE-G2-DRV-25W	RP-LBE-G2-DRV-25W-HV	RP-LBE-G2-DRV-45W	RP-LBE-G2-DRV-45W-HV	RP-LBE-G2-DRV-80W	RP-LBE-G2-DRV-80W-HV
LED OUTPUT CHANNEL(S)	Single Channel	Single Channel	Single Channel	Single Channel	Single Channel	Single Channel	Single Channel	Single Channel
LED OUTPUT CURRENT - SELECTABLE (mA)	100/150/190/230	100/150/190/230	290/350/390/490	290/350/390/490	580/680/780/880	580/680/780/880	1000/1160/1370/1570	1000/1160/1370/1570
LED DC VOLTAGE RANGE	30-48V	30-48V	30-48V	30-48V	30-48V	30-48V	30-48V	30-48V
RATED POWER (MAX)	12W	12W	25W	25W	45W	45W	80W	80W
AUX VOLTAGE SOURCE	12V/50mA	12V/50mA	12V/50mA	12V/50mA	12V/50mA	12V/50mA	12V/50mA	12V/50mA

INPUT	RP-LBE-G2-DRV-12W	RP-LBE-G2-DRV-12W-HV	RP-LBE-G2-DRV-25W	RP-LBE-G2-DRV-25W-HV	RP-LBE-G2-DRV-45W	RP-LBE-G2-DRV-45W-HV	RP-LBE-G2-DRV-80W	RP-LBE-G2-DRV-80W-HV
VOLTAGE RANGE	120-277VAC	120-347VAC	120-277VAC	120-347VAC	120-277VAC	120-347VAC	120-277VAC	120-347VAC
FREQUENCY RANGE	50~60HZ							
POWER FACTOR (TYP)	>0.9	>0.9	>0.9	>0.9	>0.9	>0.9	>0.9	>0.9
AC CURRENT (MAX)	0.15A @ 120V	0.15A @ 120V	0.22 @ 120V	0.22 @ 120V	0.38 @ 120V	0.38 @ 120V	0.70 @ 120V	0.70 @ 120V
LEAKAGE CURRENT	<0.75mA	<0.75mA	<0.75mA	<0.75mA	<0.75mA	<0.75mA	<0.75mA	<0.75mA
INRUSH CURRENT	50A @ 277V	50A @ 277V	50A @ 277V	50A @ 277V	50A @ 277V	50A @ 277V	50A @ 277V	50A @ 277V
THD	<0.20	<0.20	<0.20	<0.20	<0.20	<0.20	<0.20	<0.20

PROTECTION	RP-LBE-G2-DRV-12W	RP-LBE-G2-DRV-12W-HV	RP-LBE-G2-DRV-25W	RP-LBE-G2-DRV-25W-HV	RP-LBE-G2-DRV-45W	RP-LBE-G2-DRV-45W-HV	RP-LBE-G2-DRV-80W	RP-LBE-G2-DRV-80W-HV
OVER CURRENT	105~125% Protection type: Shut down output voltage							
LED SHORT CIRCUIT	A short condition on any of output shall cause no damage to the power supply. The unit shall recover and function automatically as soon as the short condition is removed.							
LED OPEN CIRCUIT	An open condition on any of output shall cause no damage to the power supply. The unit shall recover and function automatically as soon as the open condition is removed.							
OVER VOLTAGE	105~125% Protection type: Shut down output voltage							
SAFTEY	UL8750 CLASS 2 CLASS P							
SURGE PROTECTION	2.5 Kv							

ENVIRONMENT	RP-LBE-G2-DRV-12W	RP-LBE-G2-DRV-12W-HV	RP-LBE-G2-DRV-25W	RP-LBE-G2-DRV-25W-HV	RP-LBE-G2-DRV-45W	RP-LBE-G2-DRV-45W-HV	RP-LBE-G2-DRV-80W	RP-LBE-G2-DRV-80W-HV
WORKING TEMP	-4F to 122F							
WORKING HUMIDITY	< 90% RH							
STORAGE TEMP	-4F to 176F							
STORAGE HUMIDITY	< 90% RH							
TEMP COEFFICIENT	0.03%/°C (0~40°C)							
VIBRATION	10~500Hz, 2G 12Min / 1cycle, period for 72min each along X, Y, Z axes							

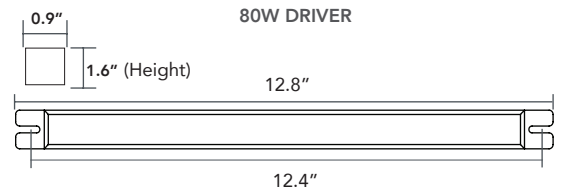
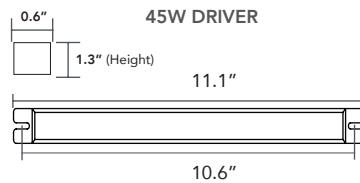
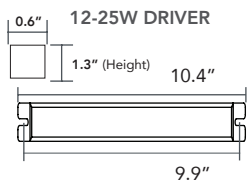



## DIMMING OPTIONS

**10V** – Standard driver is controlled with 0-10V wall dimmer or 0-10V advanced control system. (Standard driver has Aux power [12V – 50mA]; Dim-to-Off)

**LVD** – 120-277V TRIAC / AC Phase cut dimming (Driver)  
– Traditional AC modulated dimming. Compatible with forward or reverse phase cut dimming. CFL/LED compatible dimmer required.

**1STEP** – Single Switch Step-Dimming (Module to be used with LBE 10V kits) Quick flip [ON-OFF-ON] to toggle between step dimming. [30% - 60% - 100%]

**2STEP** – Double Switch Step-Dimming (Driver) Use 2 switches to control dimming steps in logical way. Designed to retrofit fluorescent in-board / out-board set-up. [30% - 60% - 100%]

## DIMMING EXPANDED

**10V**  
(STANDARD DRIVER)



**0-10V DIM**  
(Dim-to-off)  
(Aux 12V; mA)  
(0-10V use with wall dimmer or 0-10V Advanced Control)

AC POWER      0-10V

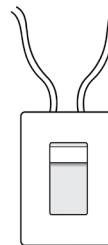

**LVD**  
(OPTIONAL DRIVER)



**120-277V TRIAC (PHASE CUT)**  
(CFL/LED Compatible dimmer required)

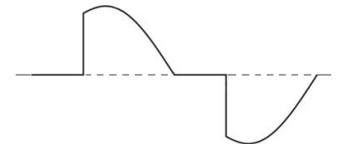
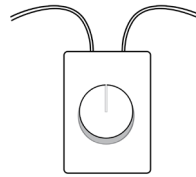

**1STEP**  
(OPTIONAL CONTROL MODULE)



**SINGLE SWITCH STEP DIM MODULE**  
(Use w/ standard LBE control ready driver)  
Quick flip [ON-OFF-ON] to toggle between step dimming. [30% - 60% - 100%]



**2STEP**  
(OPTIONAL DRIVER)



**2 SWITCH**  
(Fluorescent in-board / out-board retrofit)

30%

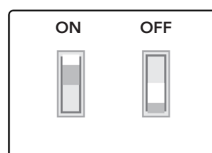

60%

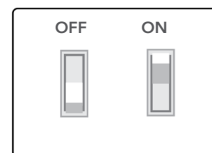

100%

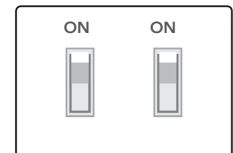



# URNS ON WHEN POWER GOES OFF

EASILY ADD EM TO THESE FIXTURE STYLES, AND MORE!

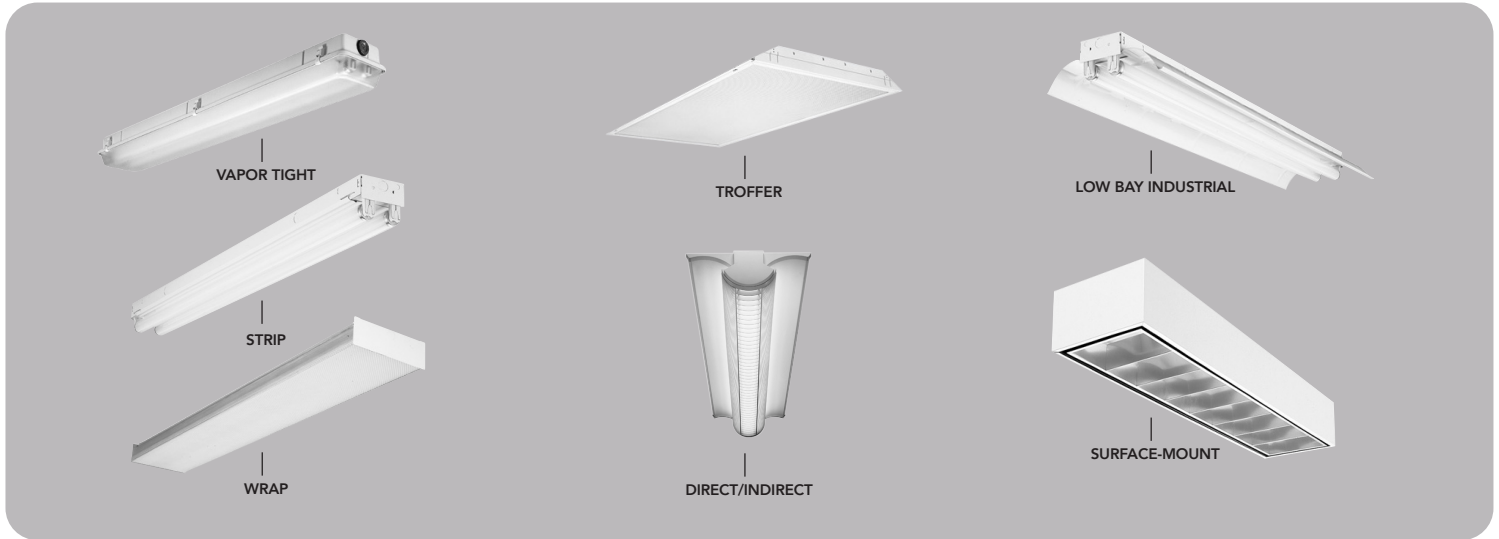

EMG KIT W/  
LED-PCB

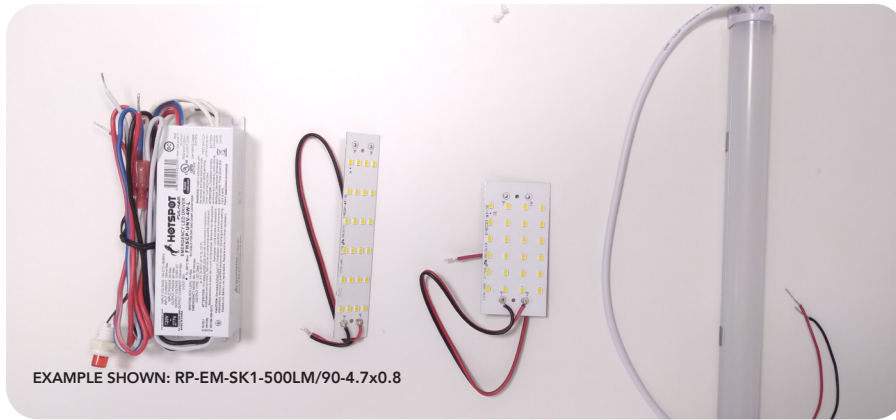

EXAMPLE SHOWN: RP-EM-SK1-500LM/90-4.7x0.8



5 YEAR WARRANTY



90 MIN RUN TIME



120-277V



41°F TO 131°F  
OPERATING TEMP



OPTIONAL EMG  
BATTERY BACKUP

PART #	UPC	WATTAGE	LUMENS	CCT	BATTERY RUN TIME	LED MODULE SIZE
RP-EM-SK1-500LM/90-3x1.5	844006072629	4W	500	5000K	90 MIN	3" x 1.5"
RP-EM-SK1-500LM/90-4.7x0.8	844006072636					4.7" x 0.8"
RP-EM-SK1-500LM/90-1FT	844006072643					10.2" x 0.9"



PRODUCT SPEC	INFORMATION
Input Voltage / Frequency	120-277V~ , 50/60Hz
Input Current	100mA Max
Input Power	3W
Standby Power	<0.85W
Driver Type	Constant Power
Current Rated	333mA@12V,73mA@55V
Output Voltage Range	12-55V
Output Power	4W
Output Class	LED Class2
Number of Output Channels	1Channel
Test Switch	Test Switch Included
Pilot Light	Red Light
Battery ON/OFF	wire+Connector
Dry Location	Dry Location
Input Surge Protection	Line-Neutral 1kV, Line & Neutral-Ground 2kV
Emergency Mode Protections	Battery Over Voltage Protection Battery Under Voltage Protection Battery Hot Plug at Normal Mode Protection Battery Hot Plug at Emergency Mode Protection
RFI/EMI	FCC Part 15 ClassA
Ambient Operating Temperature Range	5°C To 55°C(41°F To 131°F)
Battery Type	LiFePO4
Battery Voltage	6.4V
Battery Capacity	2Ah Max
Battery Charge Current	165mA
Battery Recharge Time	12 Hours
Battery Discharge Time	Min 90 Minutes
Service Life	50,000 hours
Warranty	5 years



## EMG DRIVER DIMENSIONS

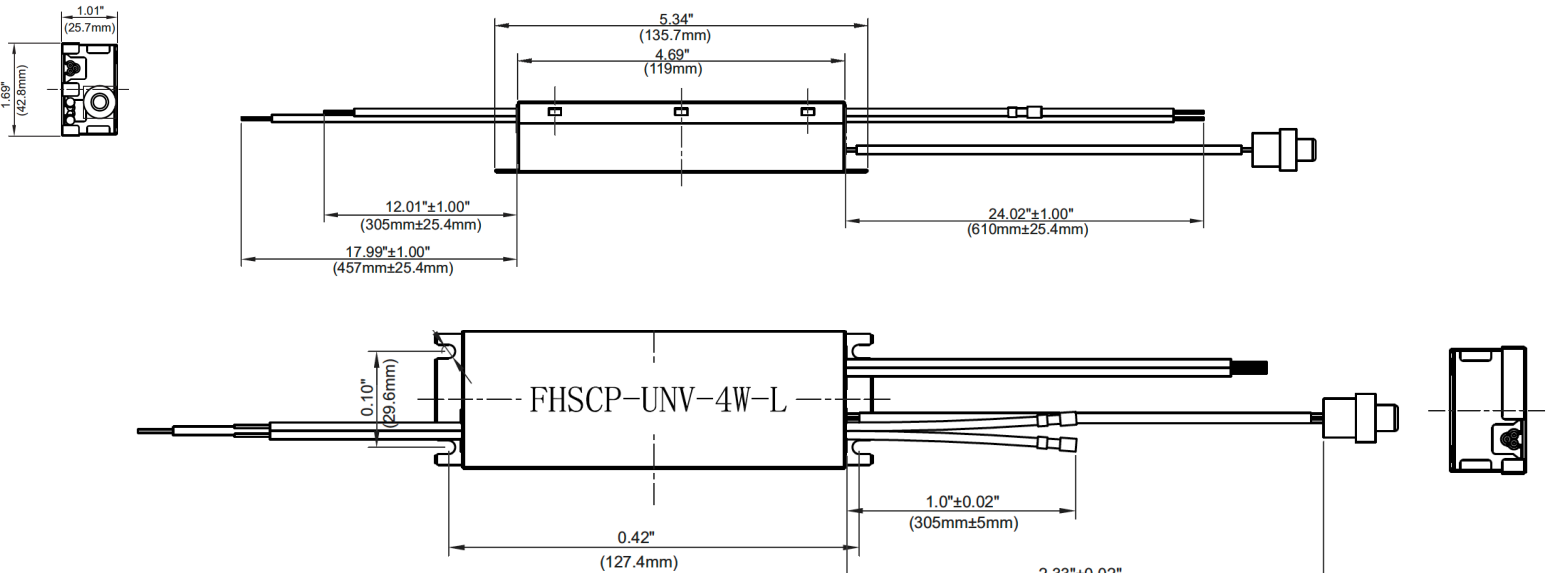

## LED MODULE DIMENSIONS - TO RECEIVE THIS KIT SIZE ORDER RP-EM-SK1-500LM/90-3X1.5

### LENGTH

- 1FT = 10.2"
- 2FT = 21.65"
- 3FT = 34.25"
- 4FT = 44.37"

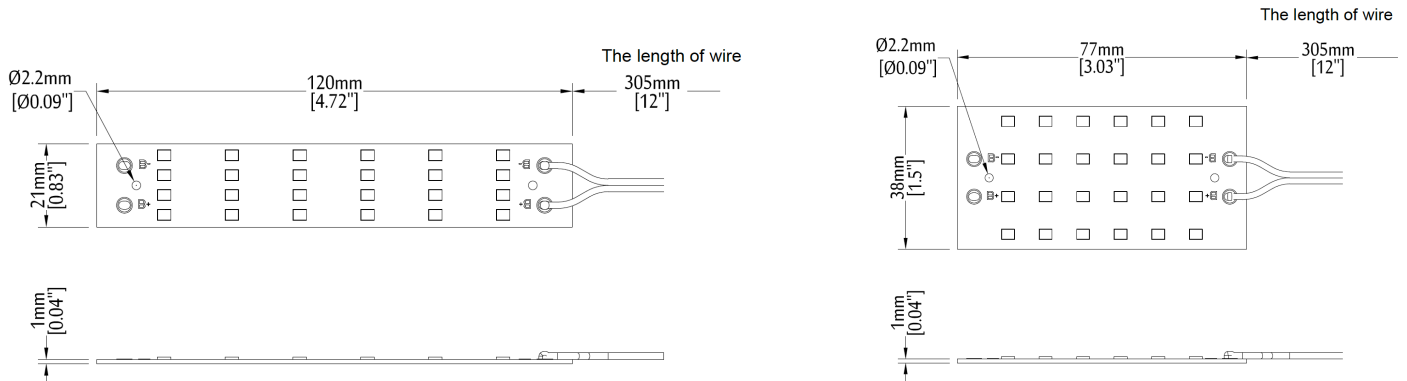
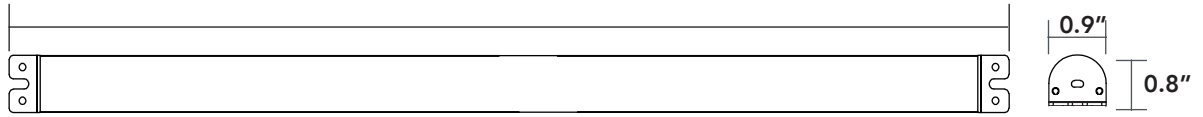



## WIRING DIAGRAM - STAND-ALONE KIT

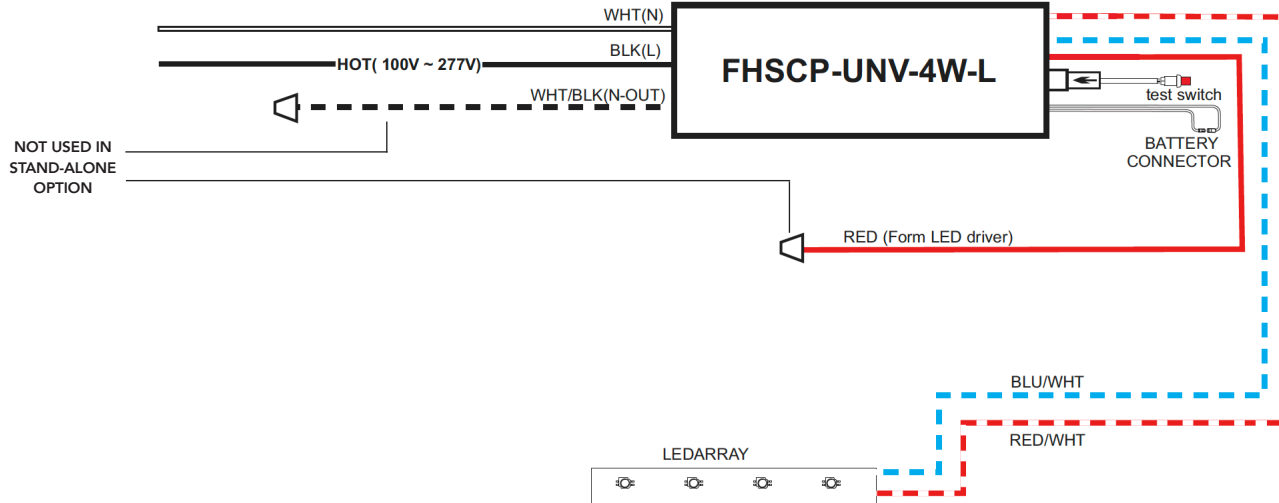

## ADDITIONAL INSTALL EXAMPLES



EXAMPLE SHOWN: RP-EM-SK1-500LM/90-1FT



ORDERING **RC-OCC-HNS-111-A** IN ADDITION TO THE LBE PART NUMBER UPGRADES THE FIXTURE WITH A FACTORY INSTALLED **SIMPLE CONTROL** UTILIZING A MICROWAVE MOTION SENSOR. IT ALSO COMES EQUIPPED WITH A DAYLIGHT HARVESTING SENSOR TO DIM AND/OR TURN OFF THE LBE WHEN THE SPACE IS UNOCCUPIED OR SURROUNDING NATURAL LIGHT LEVELS ARE HIGH.



### ATTRIBUTES

<b>DETECTION TECHNOLOGY</b>	MICROWAVE
<b>DETECTION TYPE</b>	OCCUPANCY
<b>SENSOR POWER</b>	12VDC
<b>GROUPABLE</b>	NO
<b>NETWORK LIGHTING CONTROL</b>	NO
<b>COMMISSIONING METHOD</b>	IR REMOTE
<b>REMOTE</b>	IR12
<b>DAYLIGHT HARVESTING</b>	YES
<b>HI OR LOW TRIM</b>	NO
<b>BI-LEVEL DIMMING</b>	YES
<b>NETWORK TECHNOLOGY</b>	NONE
<b>INSTALLATION TYPE</b>	INTERNAL
<b>DLC LISTED</b>	YES
<b>CONTROL CAPACITY</b>	10 FIXTURES

### IR12 REMOTE



- Permanent ON/OFF Function
- Dim +/-
- Sensor Mode
- Reset Function
- Ambient Learn
- Test Mode

FOR MORE INFORMATION ON THE IR12 REMOTE SCAN BELOW



### DETECTION PATTERN / RC-OCC-HNS-111-A

#### CEILING MOUNTING

DETECTION RANGE (FT)

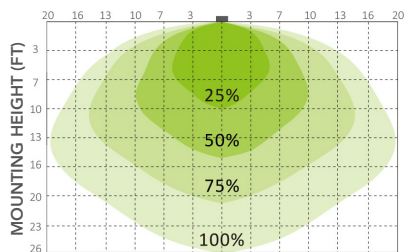

#### WALL MOUNTING

DETECTION DISTANCE (FT)

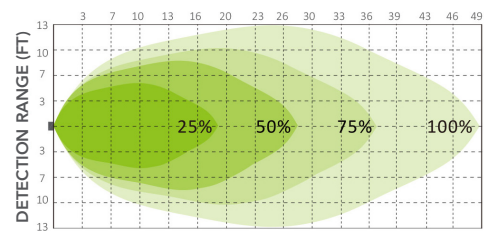

### DAYLIGHT HARVESTING / RC-OCC-HNS-111-A

Sensor detects the difference between natural light and artificial light (lamp) from behind the diffuser, switch on automatically (even without movements) when the ambient light is below the target value, and switch off automatically whenever the artificial light is not required (ambient light meets target level).

**NOTE** LUX-OFF SAMPLING TIME - 30S. LUX-ON SAMPLING TIME - 10S. LUX-ON FUNCTION WILL ONLY OPERATE WITHOUT MOTION WHEN STANDBY IS SET TO + ∞.

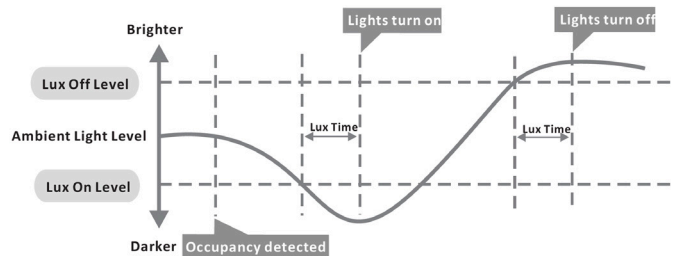



ORDERING **RC-OCLR-HNS111LR-A** IN ADDITION TO THE LBE PART NUMBER UPGRADES THE FIXTURE WITH A FACTORY INSTALLED **SIMPLE CONTROL** UTILIZING A MICROWAVE MOTION SENSOR. IT ALSO COMES EQUIPPED WITH A DAYLIGHT HARVESTING SENSOR TO DIM AND/OR TURN OFF THE LBE WHEN THE SPACE IS UNOCCUPIED OR SURROUNDING NATURAL LIGHT LEVELS ARE HIGH.



### ATTRIBUTES

<b>DETECTION TECHNOLOGY</b>	MICROWAVE
<b>DETECTION TYPE</b>	OCCUPANCY
<b>SENSOR POWER</b>	12VDC
<b>GROUPABLE</b>	NO
<b>NETWORK LIGHTING CONTROL</b>	NO
<b>COMISSIONING METHOD</b>	IR REMOTE
<b>REMOTE</b>	IR12
<b>DAYLIGHT HARVESTING</b>	YES
<b>HI OR LOW TRIM</b>	NO
<b>BI-LEVEL DIMMING</b>	YES
<b>NETWORK TECHNOLOGY</b>	NONE
<b>INSTALLATION TYPE</b>	INTERNAL
<b>DLC LISTED</b>	YES
<b>CONTROL CAPACITY</b>	10 FIXTURES

### IR12 REMOTE



- Permanent ON/OFF Function
- Dim +/-
- Sensor Mode
- Reset Function
- Ambient Learn
- Test Mode

FOR MORE INFORMATION ON THE IR12 REMOTE SCAN BELOW

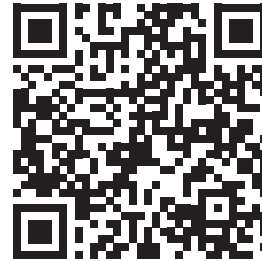

### DETECTION PATTERN / RC-OCLR-HNS111LR-A

#### CEILING MOUNTING

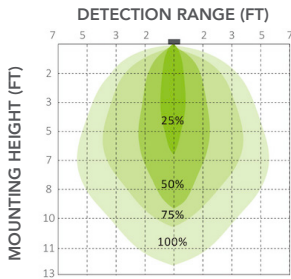

#### WALL MOUNTING

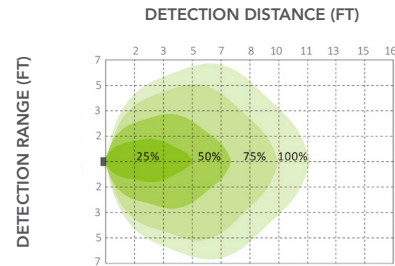

### DAYLIGHT HARVESTING / RC-OCLR-HNS111LR-A

Sensor detects the difference between natural light and artificial light (lamp) from behind the diffuser, switch on automatically (even without movements) when the ambient light is below the target value, and switch off automatically whenever the artificial light is not required (ambient light meets target level).

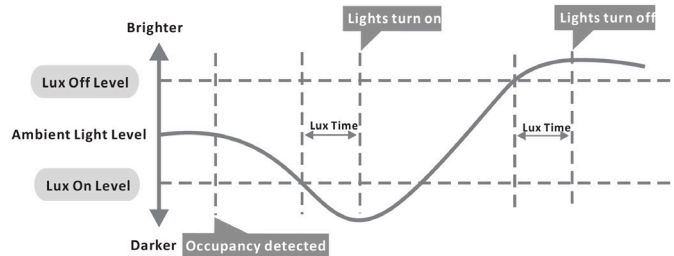

**NOTE** LUX-OFF SAMPLING TIME - 30S. LUX-ON SAMPLING TIME - 10S. LUX-ON FUNCTION WILL ONLY OPERATE WITHOUT MOTION WHEN STANDBY IS SET TO + ∞.



ORDERING **RC-OMWBT-MW-7-BLE-SR** IN ADDITION TO THE LBE PART NUMBER UPGRADES THE FIXTURE WITH A FACTORY INSTALLED **NETWORK LIGHTING CONTROL**. ONCE CONNECTED THROUGH THE SILVAIR APP, THE BLUETOOTH MICROWAVE MOTION SENSOR AND DAYLIGHT HARVESTING TECHNOLOGY CAN MAXIMIZE ENERGY SAVINGS.

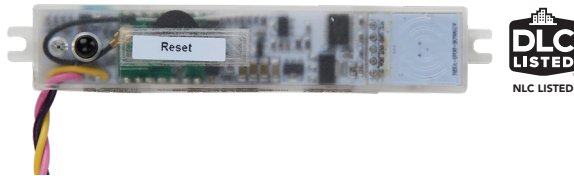

### ATTRIBUTES

<b>DETECTION TECHNOLOGY</b>	MICROWAVE
<b>DETECTION TYPE</b>	OCCUPANCY / VACANCY
<b>SENSOR POWER</b>	12VDC
<b>GROUPABLE</b>	YES
<b>NETWORK LIGHTING CONTROL</b>	YES
<b>COMMISSIONING METHOD</b>	SILVAIR APP* + IR REMOTE FOR RANGE SETTING
<b>REMOTE</b>	IR 12
<b>DAYLIGHT HARVESTING</b>	YES
<b>HI OR LOW TRIM</b>	YES
<b>BI-LEVEL DIMMING</b>	YES
<b>NETWORK TECHNOLOGY</b>	BLUETOOTH
<b>INSTALLATION TYPE</b>	INTERNAL
<b>DLC LISTED</b>	YES + DLC NLC
<b>CONTROL CAPACITY</b>	10 FIXTURES

\*SEE PAGE 10 FOR MORE INFORMATION ON SILVAIR APP

### IR12 REMOTE



IR REMOTE FOR SENSITIVITY RANGE SETTING ONLY



FOR MORE INFO SCAN ABOVE

### SILVAIR APP

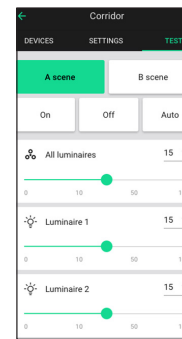

SILVAIR IS A SOFTWARE AND COMMISSIONING APP THAT CONNECTS AND CONTROLS LIGHTING FIXTURES USING BLUETOOTH MESH TECHNOLOGY.

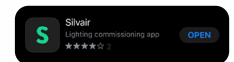

FOR MORE INFO SCAN ABOVE OR SEE PG. 10

### DETECTION PATTERN / RC-OMWBT-MW-7-BLE-SR

#### CEILING MOUNTING

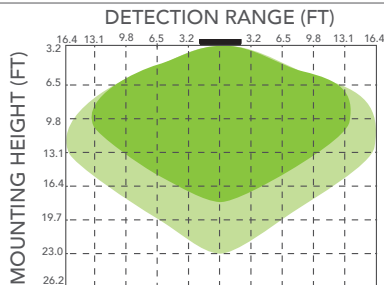

#### WALL MOUNTING

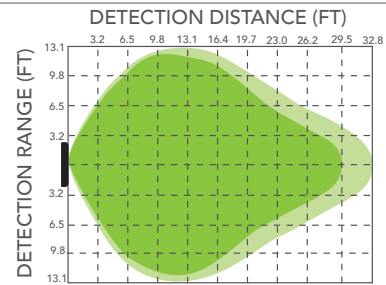

### WIRING DIAGRAM / RC-OMWBT-MW-7-BLE-SR

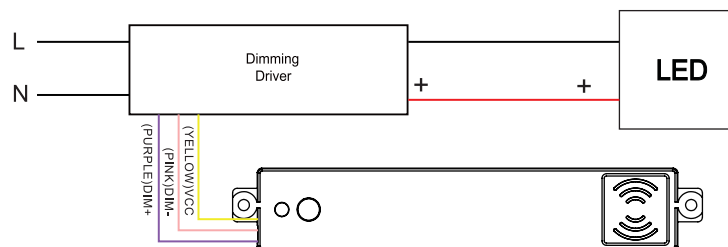



ORDERING **RC-Z10-ARM-HNB178-PIR-BLE** IN ADDITION TO THE LBE PART NUMBER UPGRADES THE FIXTURE WITH AN EXTERNAL PIR SENSOR WITH AN ADJUSTABLE ARM. ONCE CONNECTED THROUGH THE SILVAIR APP, THE BLUETOOTH MICROWAVE MOTION SENSOR AND DAYLIGHT HARVESTING TECHNOLOGY CAN MAXIMIZE ENERGY SAVINGS.



### ATTRIBUTES

<b>DETECTION TECHNOLOGY</b>	PASSIVE INFRARED (PIR)
<b>DETECTION TYPE</b>	OCCUPANCY / VACANCY
<b>SENSOR POWER</b>	12VDC
<b>GROUPABLE</b>	YES
<b>NETWORK LIGHTING CONTROL</b>	YES
<b>COMMISSIONING METHOD</b>	SILVAIR APP
<b>REMOTE</b>	N/A
<b>DAYLIGHT HARVESTING</b>	YES
<b>HI OR LOW TRIM</b>	YES
<b>BI-LEVEL DIMMING</b>	YES
<b>NETWORK TECHNOLOGY</b>	BLUETOOTH
<b>INSTALLATION TYPE</b>	1/2" NPT THREADED KNOCKOUT
<b>DLC LISTED</b>	YES + DLC NLC
<b>CONTROL CAPACITY</b>	5 FIXTURES

\*SEE PAGE 10 FOR MORE INFORMATION ON SILVAIR APP

### SILVAIR APP

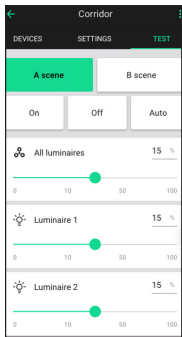

SILVAIR IS A SOFTWARE AND COMMISSIONING APP THAT CONNECTS AND CONTROLS LIGHTING FIXTURES USING BLUETOOTH MESH TECHNOLOGY.

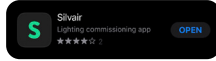

FOR MORE INFORMATION ON THE SILVAIR APP SCAN BELOW OR SEE PG. 10

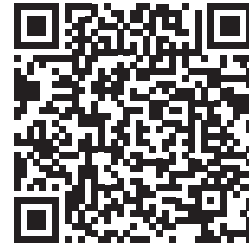

### DETECTION PATTERN / RC-OMWBT-MW-7-BLE-SR

#### CEILING MOUNTING

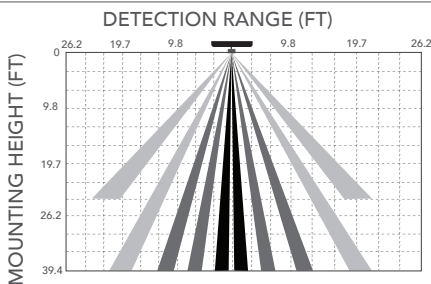

#### WALL MOUNTING

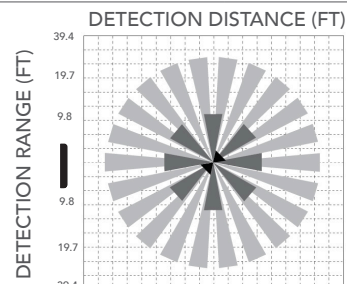

### ARM WIRING DIAGRAM

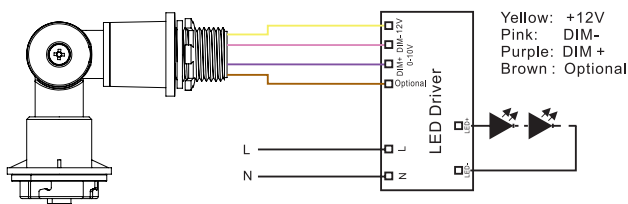

### ARM DIMENSIONS (IN)

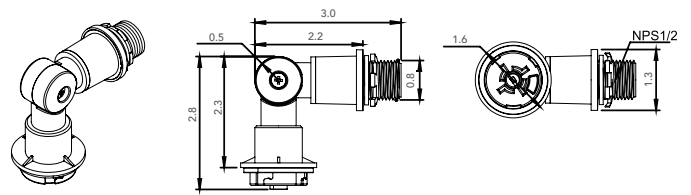



ORDERING **RC-OCCBT-HNB131PIR** IN ADDITION TO THE LBE PART NUMBER UPGRADES THE FIXTURE WITH A FACTORY INSTALLED **NETWORK LIGHTING CONTROL**. ONCE CONNECTED THROUGH THE SILVAIR APP, THE BLUETOOTH PIR MOTION SENSOR AND DAYLIGHT HARVESTING TECHNOLOGY CAN MAXIMIZE ENERGY SAVINGS.



## ATTRIBUTES

<b>DETECTION TECHNOLOGY</b>	PASSIVE INFRARED (PIR)
<b>DETECTION TYPE</b>	OCCUPANCY / VACANCY
<b>SENSOR POWER</b>	12VDC
<b>GROUPABLE</b>	YES
<b>NETWORK LIGHTING CONTROL</b>	YES
<b>COMISSIONING METHOD</b>	SILVAIR APP
<b>REMOTE</b>	IR 12
<b>DAYLIGHT HARVESTING</b>	YES
<b>HI OR LOW TRIM</b>	YES
<b>BI-LEVEL DIMMING</b>	YES
<b>NETWORK TECHNOLOGY</b>	BLUETOOTH
<b>INSTALLATION TYPE</b>	INTERNAL
<b>DLC LISTED</b>	YES + DLC NLC

\*SEE PAGE 10 FOR MORE INFORMATION ON SILVAIR APP

## SILVAIR APP

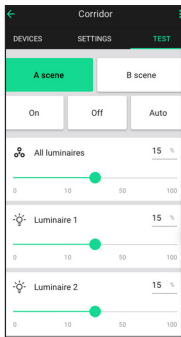

SILVAIR IS A SOFTWARE AND COMMISSIONING APP THAT CONNECTS AND CONTROLS LIGHTING FIXTURES USING BLUETOOTH MESH TECHNOLOGY.

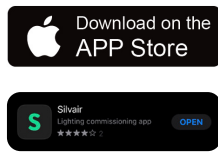

FOR MORE INFORMATION ON THE SILVAIR APP SCAN BELOW OR SEE PG. 10

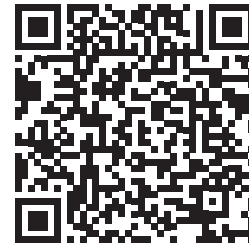

## DETECTION PATTERN

TOP VIEW

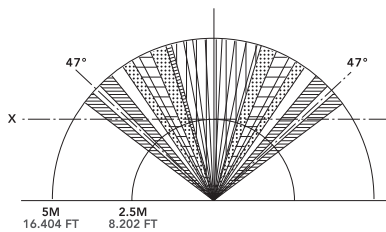

SIDE VIEW

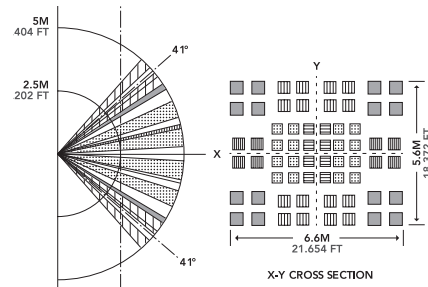

## WIRING DIAGRAM / RC-OCCBT-HNB131PIR

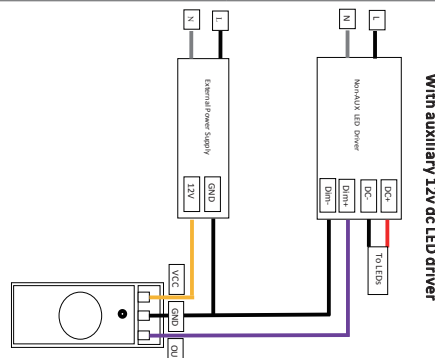



ORDERING **RC-BT-HNB131CTL** IN ADDITION TO THE LBE PART NUMBER UPGRADES THE FIXTURE WITH A FACTORY INSTALLED **NETWORK LIGHTING CONTROL**. CONNECT THROUGH THE SILVAIR APP ON ROBUST BLUETOOTH MESH. CAN BE PAIRED WITH A SWITCH FOR WIRELESS DIMMING CONTROL OR CONNECT TO OTHER FIXTURES WITH SENSORS TO MAXIMIZE COST SAVINGS.



### ATTRIBUTES

<b>DETECTION TECHNOLOGY</b>	NONE
<b>DETECTION TYPE</b>	NONE
<b>SENSOR POWER</b>	12VDC
<b>GROUPABLE</b>	YES
<b>NETWORK LIGHTING CONTROL</b>	YES
<b>COMISSIONING METHOD</b>	NONE
<b>REMOTE</b>	SILVAIR APP*
<b>DAYLIGHT HARVESTING</b>	NO
<b>HI OR LOW TRIM</b>	YES
<b>BI-LEVEL DIMMING</b>	NO
<b>NETWORK TECHNOLOGY</b>	BLUETOOTH
<b>INSTALLATION TYPE</b>	INTERNAL
<b>DLC LISTED</b>	YES + DLC NLC

\*SEE PAGE 10 FOR MORE INFORMATION ON SILVAIR APP

### SILVAIR APP

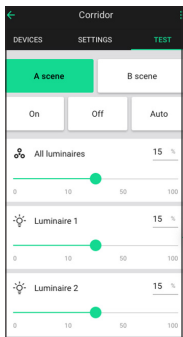

SILVAIR IS A SOFTWARE AND COMMISSIONING APP THAT CONNECTS AND CONTROLS LIGHTING FIXTURES USING BLUETOOTH MESH TECHNOLOGY.

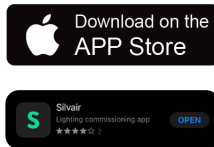

FOR MORE INFORMATION ON THE SILVAIR APP SCAN BELOW OR SEE PG. 10

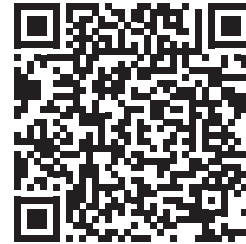



ORDERING **RC-BTX-HNB136** IN ADDITION TO THE LBE PART NUMBER UPGRADES THE FIXTURE WITH A FACTORY INSTALLED **NETWORK LIGHTING CONTROL**. CONNECT THROUGH THE SILVAIR APP ON ROBUST BLUETOOTH MESH. CAN BE PAIRED WITH A SWITCH FOR WIRELESS DIMMING CONTROL OR CONNECT TO OTHER FIXTURES WITH SENSORS TO MAXIMIZE COST SAVINGS.



### ATTRIBUTES

<b>DETECTION TECHNOLOGY</b>	NONE
<b>DETECTION TYPE</b>	NONE
<b>SENSOR POWER</b>	12VDC
<b>GROUPABLE</b>	YES
<b>NETWORK LIGHTING CONTROL</b>	YES
<b>COMMISSIONING METHOD</b>	NONE
<b>REMOTE</b>	SILVAIR APP*
<b>DAYLIGHT HARVESTING</b>	NO
<b>HI OR LOW TRIM</b>	YES
<b>BI-LEVEL DIMMING</b>	NO
<b>NETWORK TECHNOLOGY</b>	BLUETOOTH
<b>INSTALLATION TYPE</b>	INTERNAL
<b>DLC LISTED</b>	YES + DLC NLC

\*SEE PAGE 10 FOR MORE INFORMATION ON SILVAIR APP

### SILVAIR APP

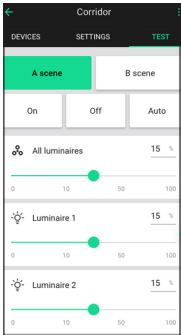

SILVAIR IS A SOFTWARE AND COMMISSIONING APP THAT CONNECTS AND CONTROLS LIGHTING FIXTURES USING BLUETOOTH MESH TECHNOLOGY.

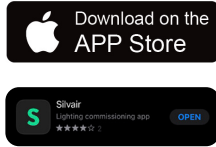

FOR MORE INFORMATION ON THE SILVAIR APP SCAN BELOW OR SEE PG. 10

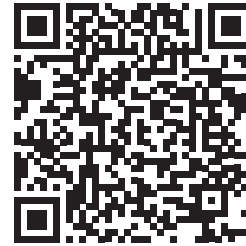

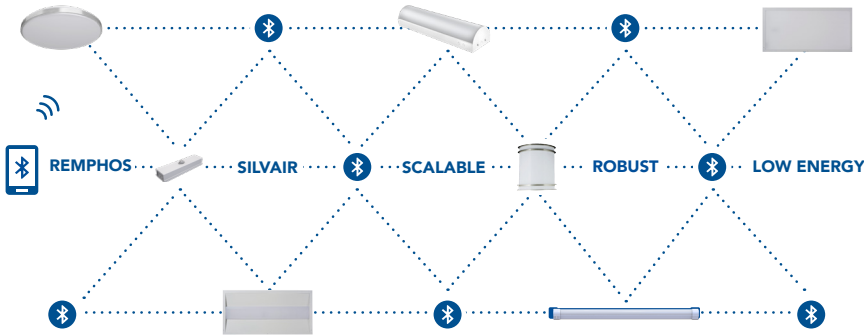

### WHAT IS SILVAIR?

Silvaire is a software and commissioning app that connects and controls lighting fixtures using Bluetooth mesh technology.

### HOW DOES IT CONNECT?

Silvaire can be set up in advance through the cloud and the Silvaire portal. It can also be commissioned in the field with the IOS app.

### DOWNLOAD SILVAIR APPS



MOBILE APP Apple App Store  
or  
WEB APP [platform.silvaire.com](http://platform.silvaire.com)

