



PART # \_\_\_\_\_

JOB NAME \_\_\_\_\_

TYPE \_\_\_\_\_



Our Linear Barkits / External Driver (LBE) for linear fluorescent luminaires is a simple, efficient retrofit solution. Designed to easily retrofit existing T5/T8/T12 linear fluorescent fixtures. Fast, one-person installation.

- Works with existing sockets—fits into the existing fixtures and speeds up the installation process
- Versatile 1 FT, 2 FT, 3 FT, 4FT, & 5 FT lamps
- Systems available from 6W (800LM) all the way to 80W (13,000LM)
- Standard 10V drivers include FlexWatt allowing you to chose the exact lumen/wattage package needed
- Streamline your retrofit project with custom professional brackets to reduce install time and variation of install
- **SIMPLE & NETWORK LIGHTING CONTROLS**



**FLEXWATT**  
SWITCH BETWEEN 4 WATTAGES

- 1 FT = 10.2"
- 2 FT = 21.65"
- 3 FT = 34.25"
- 4 FT = 44.37"
- 5 FT = 56.5"

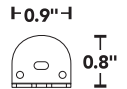
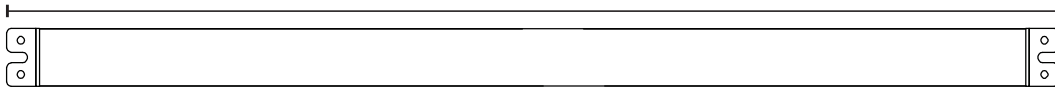

	SENSOR READY										



\*5 FT ETL PENDING



### PART NUMBER BUILDER

MFR	PRODUCT	GENERATION	WATTAGE	LENGTH	# OF LAMPS	CCT	DIMMING	CONTROLS	EMG	OPTIONS
RP	LBE	G2	12W   6 8 10 12 25W   15 18 20 25 45W   30 35 40 45 80W   50 60 70 80	1FT 2FT 3FT 4FT 5FT	1L 2L 3L 4L	8=80+ CRI  XX=CCT 30=3000K 35=3500K 40=4000K 50=5000K	10V LVD 1 STEP 2 STEP	-OCC -OCLR -OMWBT -OCCBT -OCCBT-ARM -BT -BTX	-EM1 -EM2 -EM4 -EM8 -EM9	HV (120-347V)

**EXAMPLE PART NUMBER**

RP-LBE-G2-6W-1FT-1L-840-10V-HV

Emergency battery backup options can also be ordered separately. See pages 10-13 for more information.

### CONTROL OPTIONS

#### SIMPLE LIGHTING CONTROLS



**RC-OCC-HNS-111-A**

MICROWAVE AND DAYLIGHT HARVESTING  
OCCUPANCY SENSOR  
IR12 REMOTE



**RC-OCLR-HNS111LR-A**

LIMITED RANGE MICROWAVE AND DAYLIGHT HARVESTING  
OCCUPANCY SENSOR (NO MOUNTING FEET)  
IR12 REMOTE



#### NETWORK LIGHTING CONTROLS



**RC-OCBT-HNB115MW**

SILVAIR-READY BLUETOOTH  
MICROWAVE AND DAYLIGHT  
HARVESTING OCCUPANCY  
SENSOR  
SILVAIR APP



**RC-OCCBT-HNB131PIR**

SILVAIR-READY BLUETOOTH  
PASSIVE INFRARED AND DAYLIGHT  
HARVESTING OCCUPANCY SENSOR  
(EXTERNAL FIXTURE MOUNT ONLY)  
SILVAIR APP



**RC-OCCBT-ARM-HNB178-PIR-BLE**

SILVAIR-READY BLUETOOTH  
PASSIVE INFRARED EXTERNAL ARM  
SENSOR  
SILVAIR APP



**RC-BT-HNB131CTL**

SILVAIR-READY BLUETOOTH  
CONTROL NODE  
SILVAIR APP



**RC-BTX-HNB136**

SILVAIR-READY BLUETOOTH  
NODE W/ EXTERNAL ANTENNA  
SILVAIR APP



Light Efficient Design/RemPhos has partnered with SilvaIR to offer fixtures & retrofits w/ a wireless Bluetooth-mesh eco-system. SilvaIR is listed on the DLC NLC QPL certified to Technical Requirements Version 5.1. Our SilvaIR controls meet all eligibility criteria of integral, fixture-mounted, addressable sensors with motion and photocell/ambient light-sensing capabilities, along with embedded programming that can be configured and networked. System can control motion response, illumination levels, and scheduling.



### ORDERING DIRECTIONS (SEE ORDERING GUIDE BELOW)

- (A) Choose your desired total system wattage and lumen output
- (B) Choose your desired LEDBAR length (1 FT, 2 FT, 3 FT, 4 FT, or 5 FT)
- (C) Choose your desired QTY of LEDBAR(s) per driver
- (D) Order system part # (system will include 1pc LED driver + LEDBAR(s). Substitute "XX" in the 8XX for w/ 30 (3000K), 35 (3500K), 40 (4000K) or 50 (5000K) for your desired CCT
- (E) The wattage of each LEDBAR in the system
- (F) The total system lumen output

*If the system you want is not currently a listed part #, please contact us for a letter to send to your Utility for custom incentive approval.*

**CAUTION! MAX WATTAGES PER LEDBAR**

- 1 FT: 7.5W
- 2 FT: 12.5W
- 3 FT: 15W
- 4 FT: 25W
- 5 FT: 25W

PART #	(A) WATTAGE	(B) LENGTH	(C) # OF LAMPS	(F) SYSTEM LUMENS	DLC CATEGORY	3500K	4000K	5000K
RP-LBE-G2-6W-1FT-1L-8XX-10V	6W	1FT	1	930				
RP-LBE-G2-6W-1FT-2L-8XX-10V		1FT	2	900				
RP-LBE-G2-6W-2FT-1L-8XX-10V		2FT	1	936	Linear Ambient	PRB3E2VH	PX817GIG	PHGDUW8H
RP-LBE-G2-6W-3FT-1L-8XX-10V		3FT	1	894	Linear Ambient	P1Q3OPXM	PP924MAB	PBNZQWRK
RP-LBE-G2-6W-4FT-1L-8XX-10V		4FT	1	756	Linear Ambient	P8R5JB3E	P5QXPXX0	PSW5EGIT
RP-LBE-G2-6W-5FT-1L-8XX-10V		5FT	1	756				
RP-LBE-G2-8W-1FT-1L-8XX-10V	8W	1FT	1	1240				
RP-LBE-G2-8W-1FT-2L-8XX-10V		1FT	2	1190				
RP-LBE-G2-8W-2FT-1L-8XX-10V		2FT	1	1288	Linear Ambient	P62A55CE	PVJA0P94	PQE7OFFV
RP-LBE-G2-8W-3FT-1L-8XX-10V		3FT	1	1264	Linear Ambient	PECHEP2F	PE3U62N3	P52SB5KC
RP-LBE-G2-8W-4FT-1L-8XX-10V		4FT	1	1232	Linear Ambient	PQV4C8WI	PENZ5M00	PHDXFH50
RP-LBE-G2-8W-5FT-1L-8XX-10V		5FT	1	1232				
RP-LBE-G2-10W-1FT-2L-8XX-10V	10W	1FT	2	1550				
RP-LBE-G2-10W-1FT-3L-8XX-10V		1FT	3	1488				
RP-LBE-G2-10W-2FT-1L-8XX-10V		2FT	1	1640	Linear Ambient	PAG1QYAT	PS05KCWZ	PON4R76H
RP-LBE-G2-10W-2FT-2L-8XX-10V		2FT	2	1440				
RP-LBE-G2-10W-2FT-3L-8XX-10V		2FT	3	1162				
RP-LBE-G2-10W-3FT-1L-8XX-10V		3FT	1	1640	Linear Ambient	PO7JATAZ	PQSXHIOL	P9Y4IPU5
RP-LBE-G2-10W-4FT-1L-8XX-10V		4FT	1	1630	Linear Ambient	PUPFZA3E	P7M0BTFL	P1JE9JZ6
RP-LBE-G2-10W-5FT-1L-8XX-10V		5FT	1	1630				
RP-LBE-G2-12W-1FT-2L-8XX-10V	12W	1FT	2	1860				
RP-LBE-G2-12W-1FT-3L-8XX-10V		1FT	3	1786				
RP-LBE-G2-12W-2FT-1L-8XX-10V		2FT	1	1968	Linear Ambient	PLQ8PMUV	P44M01CD	PJDFP97Z
RP-LBE-G2-12W-2FT-2L-8XX-10V		2FT	2	1728				
RP-LBE-G2-12W-2FT-3L-8XX-10V		2FT	3	1728				
RP-LBE-G2-12W-3FT-1L-8XX-10V		3FT	1	1992	Linear Ambient	POD0UQWQ	P8NS0WEQ	PYMKCGPJ
RP-LBE-G2-12W-3FT-2L-8XX-10V		3FT	2	1788				
RP-LBE-G2-12W-4FT-1L-8XX-10V		4FT	1	1956	Linear Ambient	PTM4M6BO	PLLHCS0Y	PZ8N20Q3
RP-LBE-G2-12W-4FT-2L-8XX-10V		4FT	2	1848				
RP-LBE-G2-12W-5FT-1L-8XX-10V		5FT	1	1956				
RP-LBE-G2-15W-1FT-2L-8XX-10V	15W	1FT	2	2325				
RP-LBE-G2-15W-1FT-3L-8XX-10V		1FT	3	2232				
RP-LBE-G2-15W-2FT-2L-8XX-10V		2FT	2	2340				
RP-LBE-G2-15W-2FT-3L-8XX-10V		2FT	3	2160	Troffer	PGFMWM4H	PXBV2E1D	PACQE8VC
RP-LBE-G2-15W-3FT-1L-8XX-10V		3FT	1	2505	Troffer	PTSOZL8L	PSC036CO	PGQ7VD51
RP-LBE-G2-15W-3FT-2L-8XX-10V		3FT	2	2370				
RP-LBE-G2-15W-3FT-3L-8XX-10V		3FT	3	2235				
RP-LBE-G2-15W-4FT-1L-8XX-10V		4FT	1	2505	Linear Ambient	PFBAB42G	P95LQPN8	P4IB866H
RP-LBE-G2-15W-4FT-2L-8XX-10V		4FT	2	2310	Troffer	P3TJZNK0	P2HEA375	PPCNUKDM
RP-LBE-G2-15W-5FT-1L-8XX-10V		5FT	1	2505				

\*SYSTEM LUMENS BASED ON BAR DESIGN CRITERIA



PART #	(A) WATTAGE	(B) LENGTH	(C) # OF LAMPS	(F) SYSTEM LUMENS	DLC CATEGORY	3500K	4000K	5000K		
RP-LBE-G2-18W-1FT-3L-8XX-10V	18W	1FT	3	2790						
RP-LBE-G2-18W-1FT-4L-8XX-10V		1FT	4	2678						
RP-LBE-G2-18W-2FT-2L-8XX-10V		2FT	2	2898		Troffer	P2Y1B1X1	PUPC18ML	PB45RQR6	
RP-LBE-G2-18W-2FT-3L-8XX-10V		2FT	3	2592		Troffer	PKPOHC8J	PRJQYIEJ	PQ95X3X8	
RP-LBE-G2-18W-2FT-4L-8XX-10V		2FT	4	2592						
RP-LBE-G2-18W-3FT-2L-8XX-10V		3FT	2	2844						
RP-LBE-G2-18W-3FT-3L-8XX-10V		3FT	3	2682						
RP-LBE-G2-18W-3FT-4L-8XX-10V		3FT	4	2682						
RP-LBE-G2-18W-4FT-1L-8XX-10V		4FT	1	3024		Linear Ambient	PAYNDYTS	PHFUO1IL	PEF3GEG2	
RP-LBE-G2-18W-4FT-2L-8XX-10V		4FT	2	2934		Troffer	P2JDXXCOG	PC86OTIW	P9JWLLPC	
RP-LBE-G2-18W-4FT-3L-8XX-10V		4FT	3	2772		Troffer	PZCC33MV	PZ35A5M2	PHF5RB7K	
RP-LBE-G2-18W-5FT-1L-8XX-10V		5FT	1	3024						
RP-LBE-G2-20W-1FT-3L-8XX-10V		20W	1FT	3	3100					
RP-LBE-G2-20W-1FT-4L-8XX-10V			1FT	4	2976					
RP-LBE-G2-20W-2FT-2L-8XX-10V			2FT	2	3220		Troffer	PBKQL1GY	PZA4UKKG	PUZ55K88
RP-LBE-G2-20W-2FT-3L-8XX-10V	2FT		3	2880		Troffer	P8LQ5KD0	PZTA6GYH	PX49U54Z	
RP-LBE-G2-20W-2FT-4L-8XX-10V	3FT		4	2880						
RP-LBE-G2-20W-3FT-2L-8XX-10V	3FT		2	3280						
RP-LBE-G2-20W-3FT-3L-8XX-10V	3FT		3	3160						
RP-LBE-G2-20W-3FT-4L-8XX-10V	3FT		4	3160						
RP-LBE-G2-20W-4FT-1L-8XX-10V	4FT		1	3360		Linear Ambient	PLYHZD1Z	P3U4EIAF	P8NNERJ7	
RP-LBE-G2-20W-4FT-2L-8XX-10V	4FT		2	3260		Troffer	P9IB4W7O	POK6M2XP	PH9386HN	
RP-LBE-G2-20W-4FT-3L-8XX-10V	4FT		3	3080		Troffer	PLOSOXVE	PL4ZAMLI	PXBW8K6S	
RP-LBE-G2-20W-4FT-1L-8XX-10V	5FT		1	3360						
RP-LBE-G2-25W-1FT-4L-8XX-10V	25W		1FT	4	3875					
RP-LBE-G2-25W-2FT-2L-8XX-10V			2FT	2	4100		Troffer	PMDC3DLY	PKL6SFJP	PSQD1UTC
RP-LBE-G2-25W-2FT-3L-8XX-10V			2FT	3	4025		Troffer	PQUGP3E1	P6RV8JX4	PDPD6MP2
RP-LBE-G2-25W-2FT-4L-8XX-10V		2FT	4	3900						
RP-LBE-G2-25W-3FT-3L-8XX-10V		3FT	3	4100						
RP-LBE-G2-25W-3FT-4L-8XX-10V		3FT	4	3950						
RP-LBE-G2-25W-4FT-1L-8XX-10V		4FT	1	4175		Linear Ambient	POJBJTPC	PR17YM6C	PW9U36FX	
RP-LBE-G2-25W-4FT-2L-8XX-10V		4FT	2	4175		Troffer	PNVYU5CC	PHS92SIE	PY4COSG4	
RP-LBE-G2-25W-4FT-3L-8XX-10V		4FT	3	3850		Troffer	P3MWG6MS	PSE0GEDN	PA60KY3D	
RP-LBE-G2-25W-4FT-4L-8XX-10V		4FT	4	3850						
RP-LBE-G2-25W-5FT-1L-8XX-10V		5FT	1	4175						
RP-LBE-G2-25W-5FT-2L-8XX-10V		5FT	2	4175						
RP-LBE-G2-30W-2FT-3L-8XX-10V		30W	2FT	3	4920		Troffer	PM44IVJJ	P3A4HYT7	P5USDXGC
RP-LBE-G2-30W-2FT-4L-8XX-10V			2FT	4	4830					
RP-LBE-G2-30W-3FT-3L-8XX-10V			3FT	3	4980					
RP-LBE-G2-30W-3FT-4L-8XX-10V	3FT		4	4740						
RP-LBE-G2-30W-4FT-2L-8XX-10V	4FT		2	5040		Troffer	PQI4QKFX	PWS00OZ8	P3RAZEDK	
RP-LBE-G2-30W-4FT-3L-8XX-10V	4FT		3	4890		Troffer	PZ1WEY9T	PC8JJOIQ	PJ0GHEND	
RP-LBE-G2-30W-4FT-4L-8XX-10V	4FT		4	4620		Troffer	P43S4ILF	P4WSD7GG	PBYLVMZ2	
RP-LBE-G2-30W-5FT-2L-8XX-10V	5FT		2	5040						
RP-LBE-G2-35W-2FT-3L-8XX-10V	35W		2FT	3	5740		Troffer	PE0YFJMK	P00MVBYS	PDT0BYAZ
RP-LBE-G2-35W-2FT-4L-8XX-10V		2FT	4	5635						
RP-LBE-G2-35W-3FT-3L-8XX-10V		3FT	3	5810						
RP-LBE-G2-35W-3FT-4L-8XX-10V		3FT	4	5740						
RP-LBE-G2-35W-4FT-2L-8XX-10V		4FT	2	5880		Troffer	PCEAYOLH	PHHJJ7Q7	PO5E8UIB	
RP-LBE-G2-35W-4FT-3L-8XX-10V		4FT	3	5705		Troffer	PI206DOG	PA221SYC	PREJ56PF	
RP-LBE-G2-35W-4FT-4L-8XX-10V		4FT	4	5390		Troffer	PRNA6ERF	PHRLQ6NW	PLGQQSHD	
RP-LBE-G2-35W-5FT-2L-8XX-10V		5FT	2	5880						

\*SYSTEM LUMENS BASED ON BAR DESIGN CRITERIA



PART #	(A) WATTAGE	(B) LENGTH	(C) # OF LAMPS	(F) SYSTEM LUMENS	DLC CATEGORY	3500K	4000K	5000K
RP-LBE-G2-40W-2FT-4L-8XX-10V	40W	2FT	4	6560				
RP-LBE-G2-40W-3FT-4L-8XX-10V		3FT	4	6560				
RP-LBE-G2-40W-4FT-2L-8XX-10V		4FT	2	6680	Troffer	PSAJ16B6	PIVIEP1	PFE9LAKI
RP-LBE-G2-40W-4FT-3L-8XX-10V		4FT	3	6680	Troffer	PJO5URF7	PNO08S2C	P4LWQKGI
RP-LBE-G2-40W-4FT-4L-8XX-10V		4FT	4	6520	Troffer	PMUONBP2	P3IMKH82	P5DSYCK7
RP-LBE-G2-40W-5FT-2L-8XX-10V		5FT	2	6680				
RP-LBE-G2-45W-2FT-4L-8XX-10V	45W	2FT	4	7380				
RP-LBE-G2-45W-3FT-4L-8XX-10V		3FT	4	7470				
RP-LBE-G2-45W-4FT-2L-8XX-10V		4FT	2	7425	Troffer	P29BQ4XQ	PCGLIANA	P9AGK00M
RP-LBE-G2-45W-4FT-3L-8XX-10V		4FT	3	7515	Troffer	P8K4KU9Y	P6Y6FQN6	PBM805KP
RP-LBE-G2-45W-4FT-4L-8XX-10V		4FT	4	7335	Troffer	PZQKU0RR	PH63ZGAD	PRISOQAK
RP-LBE-G2-45W-5FT-2L-8XX-10V		5FT	2	7425				
RP-LBE-G2-50W-4FT-2L-8XX-10V	50W	4FT	2	8200				
RP-LBE-G2-50W-4FT-3L-8XX-10V		4FT	3	8400	Troffer	PSCL7TGG	PK9A6WJM	PGZMX0RE
RP-LBE-G2-50W-4FT-4L-8XX-10V		4FT	4	8400	Troffer	PXY07A81	P0EJEM2B	P0R8NUEX
RP-LBE-G2-50W-5FT-2L-8XX-10V		5FT	2	8200				
RP-LBE-G2-60W-4FT-3L-8XX-10V	60W	4FT	3	10,080	Troffer	PBEJYDS6	PO6P4ODV	P6YFJD6J
RP-LBE-G2-60W-4FT-4L-8XX-10V		4FT	4	10,080	Troffer	P2EUH4QA	P1AAKG4I	PI5S9LRA
RP-LBE-G2-70W-4FT-3L-8XX-10V	70W	4FT	3	11,690	Troffer	P3HKNSD8	PMA24C2C	PDAXW1RS
RP-LBE-G2-70W-4FT-4L-8XX-10V		4FT	4	11,760	Troffer	P7LFRT4B	PKSZD1GX	P0R0U83M
RP-LBE-G2-80W-4FT-4L-8XX-10V	80W	4FT	4	13,360	Troffer	PRPYODKD	PPW0IQ1S	PNCRDNHD

\*SYSTEM LUMENS BASED ON BAR DESIGN CRITERIA



### WHY USE THE LBE?

**MORE EFFICIENT** because the higher efficiency optics, LEDs, and drivers we use provide higher lumens per watt and less wattage compared to other LED tubes.

**MORE RELIABLE** because of the significant amount of aluminum that we use as a heat sink on the back of the LBE properly dissipates the heat and keeps the electronics cooler than other LED tubes.

**MORE UNIVERSAL FIT** because our bars are designed to fit in between the sockets of either T5 or T8 fixtures. That means you can specify a 4 FT LBE for any T5 or T8 style fixture whether it is a troffer, vapor tight, pendant, strip or many other applications.

**LESS LIABILITY** get rid of the old fluorescent tube sockets that often can lead to future issues such as arcing, early failure, or even a fire.

**BETTER PIECE OF MIND** because the LBE family comes standard with a 5-year system warranty.

### MORE INFO

#### HIGHER OUTPUT TO MATCH T5HO

The LBE Barkit can be powered up to 25W for the 4 FT bar to match the foot candles of a T5HO FL lamp. All light bars are over 150LPW w/ AC wall efficiencies including the driver from 150-160LPW.

#### SINGLE CCT AVAILABLE

3000K, 3500K, 4000K, & 5000K

#### FLEXWATT STANDARD

Each driver has 4 adjustable wattage choices. With FlexWatt, there are now significantly more wattage choices to allow you to select exactly what lumen/wattage package is needed to maximize energy savings.

##### MAX WATTAGE:

- 1 FT=7.5W
- 2 FT=12.5W
- 3 FT=15W
- 4 FT=25W
- 5 FT=25W

#### DIM-TO-OFF SENSOR READY DRIVERS STANDARD

12V auxiliary power and 10V dimming wires are standard in every kit. Allowing for easy interface with dimming switches and control systems.

#### LESS WATTS TO REPLACE YOUR FLUORESCENT LAMPS

Available in 10W or even 8W options, the G2 system enables deeper energy savings. Refer to the ordering guide for available configurations.

#### VARIOUS CONTINUOUS AND STEP-DIM DRIVER OPTIONS.

We want to help you choose the lowest-cost and easiest-to-implement method to dim our retrofit kits. While low voltage 10V dimming is a great approach, it often requires running new wiring. Therefore, we have line voltage phase dimming options, 2-switch step-dim driver (to work with existing inbound/outbound wall switches), and 1-switch step-dim driver (using 1 existing wall switch to change brightness between pre-selected levels of 50%/100% for example).

#### METAL, LINEAR BALLAST SHAPED LED DRIVERS

Rigid metal cases, rugged and easy to mount. Thinner height to fit into even the most compact existing ballast compartments.

#### BUILT-IN METAL MAGNETIC MOUNTING BRACKETS

Innovative bracket that can be slid anywhere on the bar, so that the screws can be mounted in various places depending on what is fastest/easiest for the install.

#### LOWER COST EMERGENCY BATTERY BACKUP

#### VARIOUS BRACKETS AVAILABLE FROM OUR "CUSTOM-SHOP"

Have a direct/indirect pendant hung fixture and want a fast way to mount bars pointing up and down? No problem, we have a solution. Have a wide-body vapor tight where you want 6 bars mounted together along with a motion sensor on a single pan? No problem, we have a solution for that too. Let our engineers help design a bracket/mounting system that makes installation faster and easier for you.



### OPTIONAL MOUNTING BRACKETS\*

Used when mounting to an uneven fixture surface or to match heights to driver channel when de-lamping.

SHORT BRIDGE



RP-LBE-G1-SHORTBRIDGE-10P

TALL BRIDGE



RP-LBE-G1-TALLBRIDGE-10P

SHORT BRIDGE

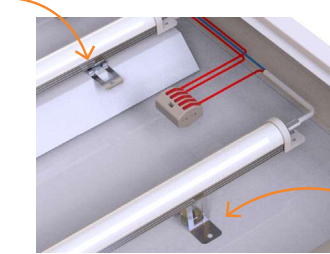

TALL BRIDGE

\* ORDERED SEPARATELY. SOLD IN PACKS OF 10

### KEY PRODUCT INFORMATION

- SIMPLE INSTALLATION
- FITS BETWEEN THE SOCKETS
- MAXIMUM VERSATILITY
- MANY LIGHT OUTPUT CHOICES
- CONTROL-READY 10V DIMMABLE DRIVER
- SUITABLE FOR DRY & DAMP LOCATIONS
- UL 1598C CLASSIFIED RETROFIT KIT LISTED & PERFORMANCE QPL LISTED
- 10 YEAR WARRANTY, L70 >100,000HRS
- CUSTOM RETROFIT SOLUTIONS AVAILABLE
- OPTIONAL MOTION SENSOR/CONTROL-READY





## SPECIFICATION GUIDE

### OUTPUT

MODEL	RP-LBE-G2-DRV-12W	RP-LBE-G2-DRV-12W-HV	RP-LBE-G2-DRV-25W	RP-LBE-G2-DRV-25W-HV	RP-LBE-G2-DRV-45W	RP-LBE-G2-DRV-45W-H	RP-LBE-G2-DRV-80W	RP-LBE-G2-DRV-80W-HV
LED OUTPUT CHANNEL(S)	SINGLE CHANNEL							
LED OUTPUT CURRENT - SELECTABLE (MA)	100/150/190/230		290/350/390/490		580/680/780/880		1000/1160/1370/1570	
LED DC VOLTAGE RANGE	30-48V							
RATED POWER (MAX)	12W		25W		45W		80W	
AUX VOLTAGE SOURCE	12V/50mA							

### INPUT

VOLTAGE RANGE	120-277VAC	120-347VAC	120-277VAC	120-347VAC	120-277VAC	120-347VAC	120-277VAC	120-347VAC
FREQUENCY RANGE	50-60HZ							
POWER FACTOR (TYP)	>0.95							
AC CURRENT (MAX)	0.15A @ 120V		0.22 @ 120V		0.38 @ 120V		0.70 @ 120V	
LEAKAGE CURRENT	> 0.75mA							
INRUSH CURRENT	50A @ 277V							
THD	<0.20							

### PROTECTION

OVER CURRENT	105~125% Protection type: Shut down output voltage
LED SHORT CIRCUIT	A short condition on any output shall cause no damage to the power supply. The unit shall recover and function automatically as soon as the short condition is removed.
LED OPEN CIRCUIT	An open condition on any output shall cause no damage to the power supply. The unit shall recover and function automatically as soon as the open condition is removed.
OVER VOLTAGE	105~125% Protection type: Shut down output voltage
SAFTEY	UL8750 CLASS 2 CLASS P
SURGE PROTECTION	2.5 Kv

### ENVIRONMENT

WORKING TEMP	-4F to 122F
WORKING HUMIDITY	< 90% RH
STORAGE TEMP	-4F to 176F
STORAGE HUMIDITY	< 90% RH
TEMP COEFFICIENT	0.03%/°C (0~40°C)
VIBRATION	10~500Hz, 2G 12Min / 1cycle, period for 72min each along X, Y, Z axes

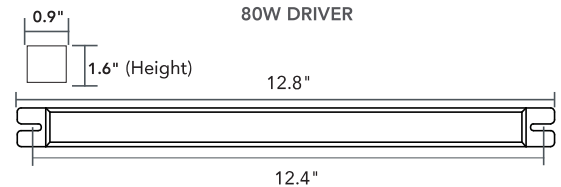
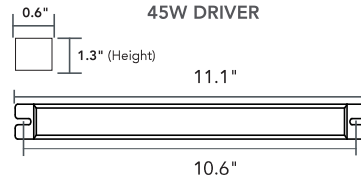
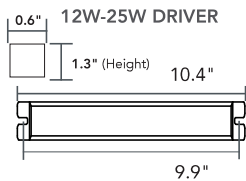



### DIMMING OPTIONS

**10V** – Standard driver is controlled with 0-10V wall dimmer or 0-10V advanced control system. (Standard driver has Aux power [12V – 50mA]; Dim-to-Off)

**LVD** – 120-277V TRIAC / AC Phase cut dimming (Driver) Traditional AC modulated dimming. Compatible with forward or reverse phase cut dimming. CFL/LED compatible dimmer required. Selecting LVD results in the loss of FlexWatt capabilities.

**1STEP** – Single Switch Step-Dimming (Module to be used with LBE 10V kits) Quick flip [ON-OFF-ON] to toggle between step dimming. [30% - 60% - 100%]

**2STEP** – Double Switch Step-Dimming (Driver) Use 2 switches to control dimming steps in logical way. Designed to retrofit fluorescent in-board / out-board set-up. [30% - 60% - 100%]

### DIMMING EXPANDED

**10V**  
(STANDARD DRIVER)

→ **0-10V DIM**  
(Dim-to-off)  
(Aux 12V; mA)  
(0-10V use w/ wall dimmer or 0-10V Advanced Control)

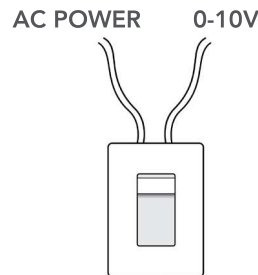

**LVD**  
(OPTIONAL DRIVER)

→ **120-277V TRIAC (PHASE CUT)**  
(CFL/LED compatible dimmer required)

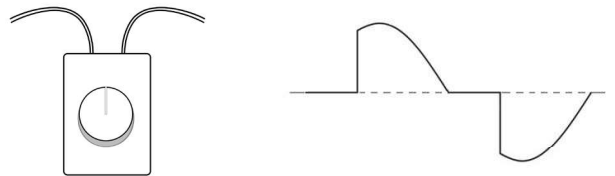

**1STEP**  
(OPTIONAL CONTROL MODULE)

→ **SINGLE SWITCH STEP DIM MODULE**  
(Use w/ standard LBE control-ready driver)  
Quick flip [ON-OFF-ON] to toggle between step dimming. [30% - 60% - 100%]



**2STEP**  
(OPTIONAL DRIVER)

→ **2 SWITCH**  
(Fluorescent in-board / out-board retrofit)

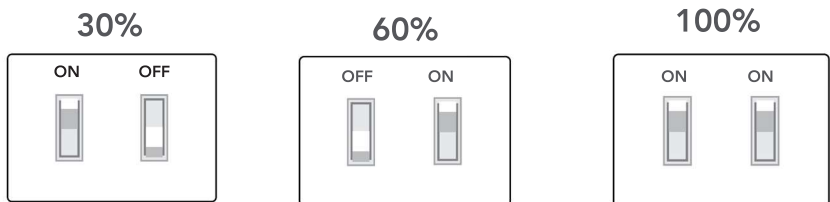



URNS ON WHEN POWER GOES OFF



90 MIN RUN TIME



41°F TO 131°F  
OPERATING TEMP



OPTIONAL EMG  
BATTERY BACKUP

EASILY ADD EM TO THESE FIXTURE STYLES, AND MORE!



VAPOR TIGHT



TROFFER



LOW BAY INDUSTRIAL



STRIP



DIRECT/INDIRECT



WRAP

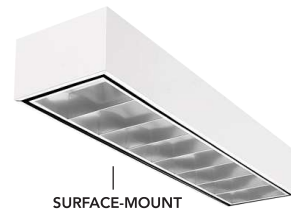

SURFACE-MOUNT

EMG KIT W/  
LED-PCB

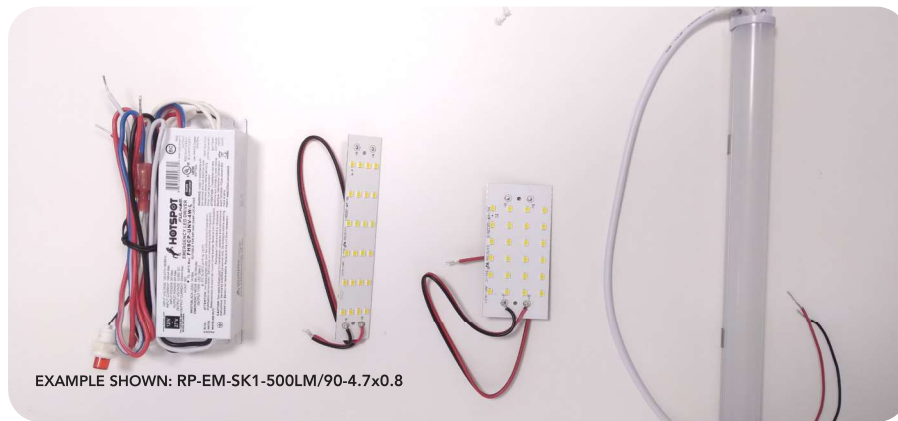

EXAMPLE SHOWN: RP-EM-SK1-500LM/90-4.7x0.8

PART #	UPC	WATTAGE	LUMENS	CCT	BATTERY RUN TIME	LED MODULE SIZE
RP-EM-SK1-500LM/90-3x1.5	844006072629	4W	500	5000K	90 MIN	3.0" x 1.5"
RP-EM-SK1-500LM/90-4.7x0.8	844006072636					4.7" x 0.8"
RP-EM-SK1-500LM/90-1FT	844006072643					10.2" x 0.9"



PRODUCT SPEC	INFORMATION
INPUT VOLTAGE / FREQUENCY	120-277V~, 50/60Hz
INPUT CURRENT	100mA Max
INPUT POWER	3W
STANDBY POWER	<0.85W
DRIVER TYPE	Constant Power
CURRENT RATED	333mA @ 12V, 73mA @ 55V
OUTPUT VOLTAGE RANGE	12-55V
OUTPUT POWER	4W
OUTPUT CLASS	LED Class 2
NUMBER OF OUTPUT CHANNELS	1
TEST SWITCH	Included
PILOT LIGHT	Red Light
BATTERY ON/OFF	Wire + Connector
LOCATION TYPE	Dry Location
INPUT SURGE PROTECTION	Line-Neutral 1kV, Line & Neutral-Ground 2kV
EMERGENCY MODE PROTECTIONS	Battery Over Voltage Protection Battery Under Voltage Protection Battery Hot Plug at Normal Mode Protection Battery Hot Plug at Emergency Mode Protection
RFI/EMI	FCC Part 15 Class A
AMBIENT OPERATING TEMPERATURE RANGE	5°C To 55°C (41°F To 131°F)
BATTERY TYPE	LiFePO4
BATTERY VOLTAGE	6.4V
BATTERY CAPACITY	2Ah Max
BATTERY CHARGE CURRENT	165mA
BATTERY RECHARGE TIME	12 Hours
BATTERY DISCHARGE TIME	Minimum 90 Minutes
SERVICE LIFE	50,000 Hours
WARRANTY	5 Years



### EMG DRIVER DIMENSIONS

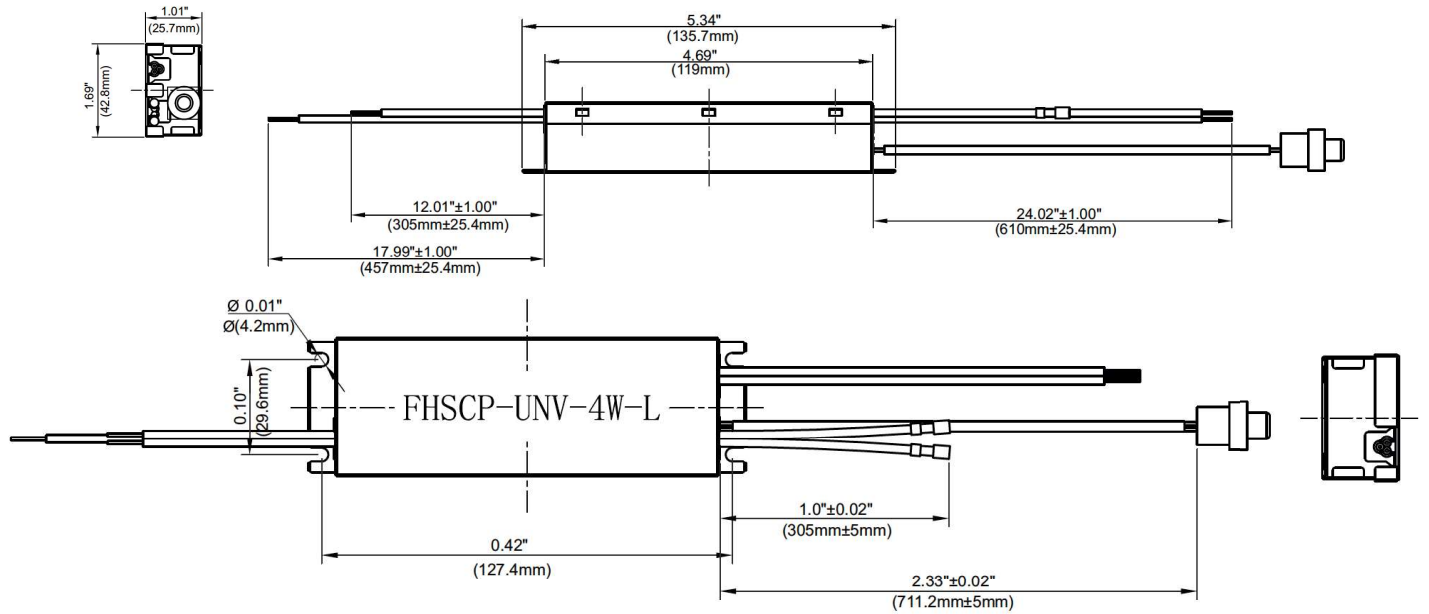

### LED MODULE DIMENSIONS - TO RECEIVE THIS KIT SIZE ORDER RP-EM-SK1-500LM/90-3X1.5

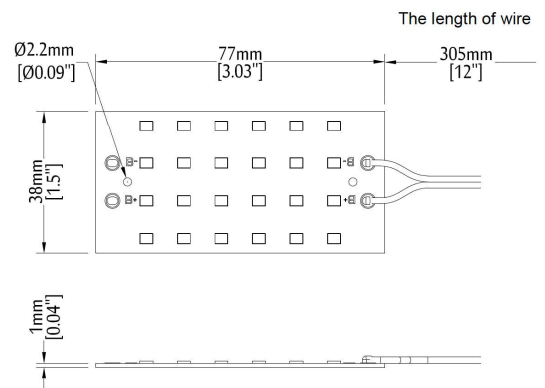
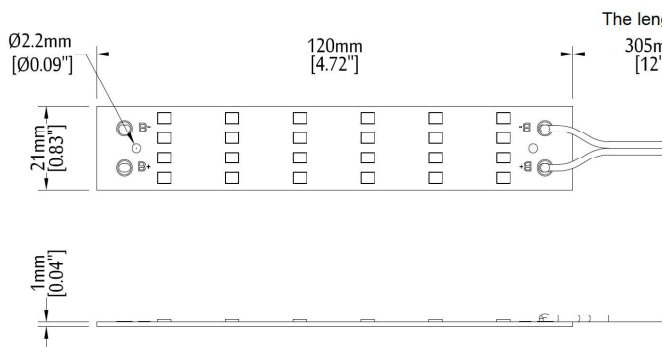
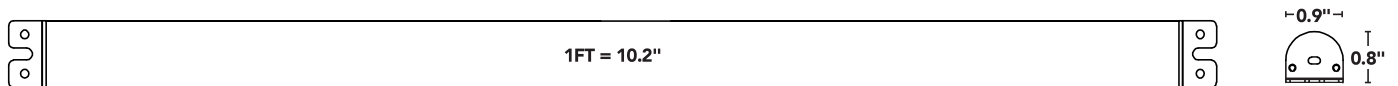



### WIRING DIAGRAM - STAND-ALONE KIT - FOR 8W CONTACT REMPHOS TECH SUPPORT

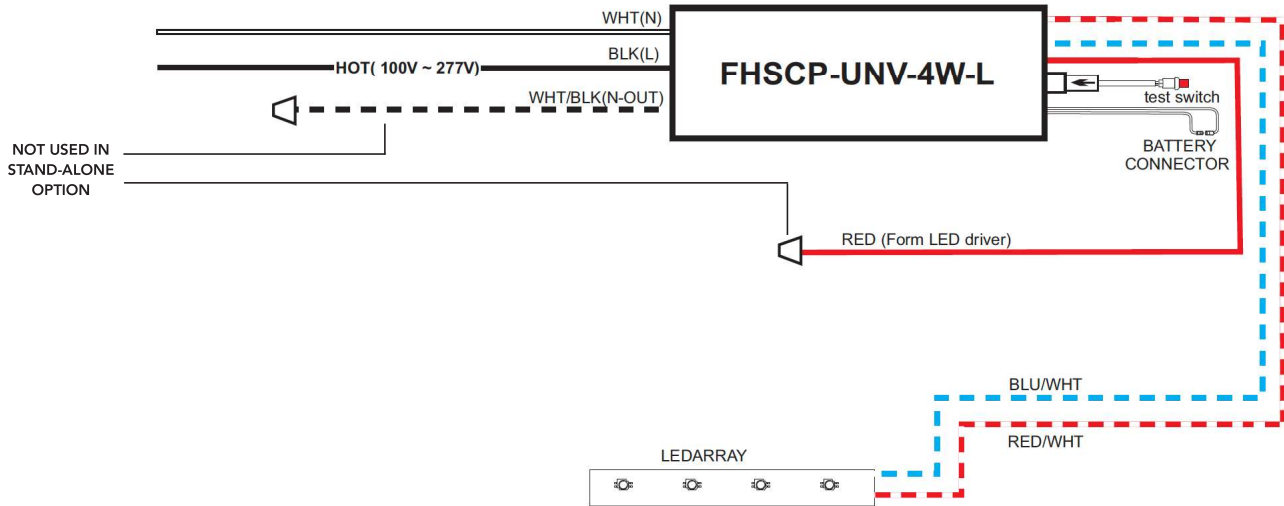

### ADDITIONAL INSTALL EXAMPLE





## MICROWAVE AND DAYLIGHT HARVESTING OCCUPANCY SENSOR

### ATTRIBUTES

<b>DETECTION TECHNOLOGY</b>	MICROWAVE
<b>DETECTION TYPE</b>	OCCUPANCY
<b>SENSOR POWER</b>	12VDC
<b>GROUPABLE</b>	NO
<b>NETWORK LIGHTING CONTROL</b>	NO
<b>COMMISSIONING METHOD</b>	IR REMOTE
<b>REMOTE</b>	IR12
<b>DAYLIGHT HARVESTING</b>	YES
<b>HI OR LOW TRIM</b>	NO
<b>BI-LEVEL DIMMING</b>	YES
<b>NETWORK TECHNOLOGY</b>	NONE
<b>INSTALLATION TYPE</b>	INTERNAL
<b>DLC LISTED</b>	YES
<b>CONTROL CAPACITY</b>	10 FIXTURES

ORDERING **RC-OCC-HNS111-A**, IN ADDITION TO THE LBE PART NUMBER, UPGRADES THE FIXTURE W/ A FACTORY INSTALLED **SIMPLE CONTROL** UTILIZING A MICROWAVE MOTION SENSOR. IT ALSO COMES EQUIPPED W/ A DAYLIGHT HARVESTING SENSOR TO DIM AND/OR TURN OFF THE LBE WHEN THE SPACE IS UNOCCUPIED OR SURROUNDING NATURAL LIGHT LEVELS ARE HIGH.



### IR12 REMOTE



- Sensor Off
- Dim +/-
- Sensor Mode
- Reset Function
- Ambient Learn
- Test Mode

FOR MORE INFORMATION ON THE IR12 REMOTE SCAN BELOW

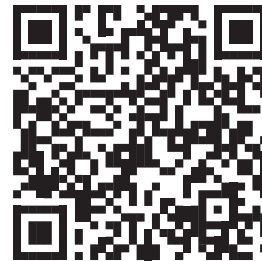

### DETECTION PATTERN / RC-OCC-HNS111-A

#### CEILING MOUNTING

##### DETECTION RANGE (FT)

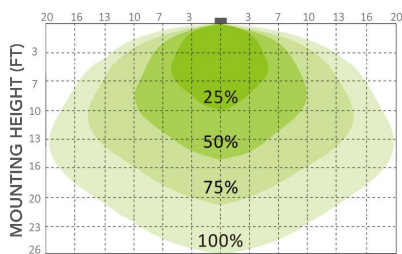

#### WALL MOUNTING

##### DETECTION DISTANCE (FT)

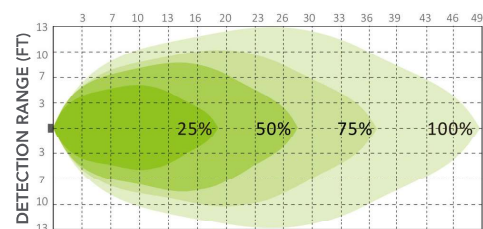

### DAYLIGHT HARVESTING / RC-OCC-HNS111-A

Sensor detects the difference between natural light and artificial light (lamp) from behind the diffuser, switch on automatically (even w/o movements) when the ambient light is below the target value, and switch off automatically whenever the artificial light is not required (ambient light meets target level).

**NOTE** LUX-OFF SAMPLING TIME - 30S. LUX-ON SAMPLING TIME - 10S. LUX-ON FUNCTION WILL ONLY OPERATE WITHOUT MOTION WHEN STANDBY IS SET TO + ∞.

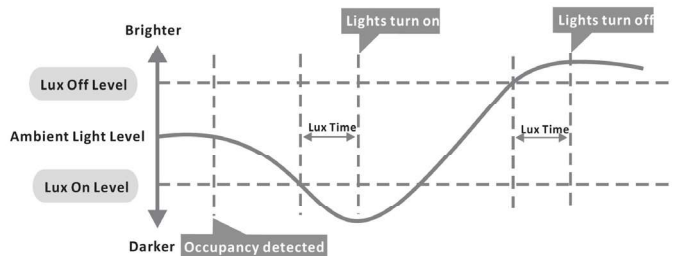



## LIMITED-RANGE MICROWAVE AND DAYLIGHT HARVESTING OCCUPANCY SENSOR

ORDERING **RC-OCLR-HNS11LR-A**, IN ADDITION TO THE LBE PART NUMBER, UPGRADES THE FIXTURE W/ A FACTORY INSTALLED **SIMPLE CONTROL** UTILIZING A MICROWAVE MOTION SENSOR. IT ALSO COMES EQUIPPED W/ A DAYLIGHT HARVESTING SENSOR TO DIM AND/OR TURN OFF THE LBE WHEN THE SPACE IS UNOCCUPIED OR SURROUNDING NATURAL LIGHT LEVELS ARE HIGH.



### ATTRIBUTES

<b>DETECTION TECHNOLOGY</b>	MICROWAVE
<b>DETECTION TYPE</b>	OCCUPANCY
<b>SENSOR POWER</b>	12VDC
<b>GROUPABLE</b>	NO
<b>NETWORK LIGHTING CONTROL</b>	NO
<b>COMMISSIONING METHOD</b>	IR REMOTE
<b>REMOTE</b>	IR12
<b>DAYLIGHT HARVESTING</b>	YES
<b>HI OR LOW TRIM</b>	NO
<b>BI-LEVEL DIMMING</b>	YES
<b>NETWORK TECHNOLOGY</b>	NONE
<b>INSTALLATION TYPE</b>	INTERNAL
<b>DLC LISTED</b>	YES
<b>CONTROL CAPACITY</b>	10 FIXTURES

### IR12 REMOTE



- Sensor Off
- Dim +/-
- Sensor Mode
- Reset Function
- Ambient Learn
- Test Mode

FOR MORE INFORMATION ON THE IR12 REMOTE SCAN BELOW



### DETECTION PATTERN / RC-OCLR-HNS11LR-A

#### CEILING MOUNTING

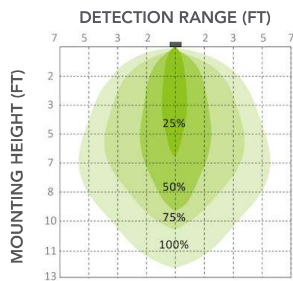

#### WALL MOUNTING

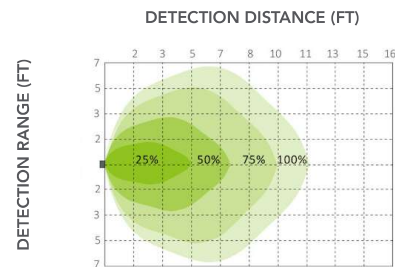

### DAYLIGHT HARVESTING / RC-OCLR-HNS11LR-A

Sensor detects the difference between natural light and artificial light (lamp) from behind the diffuser, switch on automatically (even w/o movements) when the ambient light is below the target value, and switch off automatically whenever the artificial light is not required (ambient light meets target level).

**NOTE** LUX-OFF SAMPLING TIME - 30S. LUX-ON SAMPLING TIME - 10S. LUX-ON FUNCTION WILL ONLY OPERATE WITHOUT MOTION WHEN STANDBY IS SET TO + ∞.

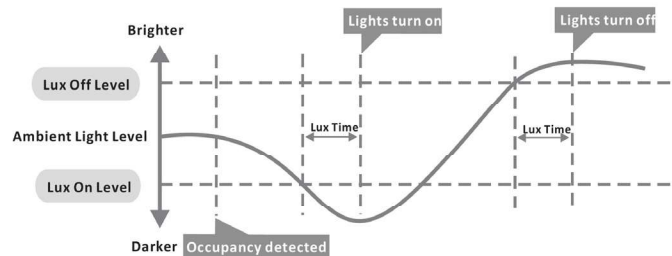



## SILVAIR-READY BLUETOOTH MICROWAVE AND DAYLIGHT HARVESTING OCCUPANCY SENSOR

ORDERING **RP-OCBT-HNB115MW**, IN ADDITION TO THE LBE PART NUMBER, UPGRADES THE FIXTURE W/ A FACTORY INSTALLED **NETWORK LIGHTING CONTROL**. ONCE CONNECTED THROUGH THE SILVAIR APP, THE BLUETOOTH MICROWAVE MOTION SENSOR AND DAYLIGHT HARVESTING TECHNOLOGY CAN MAXIMIZE ENERGY SAVINGS.



### ATTRIBUTES

<b>DETECTION TECHNOLOGY</b>	MICROWAVE
<b>DETECTION TYPE</b>	OCCUPANCY / VACANCY
<b>SENSOR POWER</b>	12VDC
<b>GROUPABLE</b>	YES
<b>NETWORK LIGHTING CONTROL</b>	YES
<b>COMMISSIONING METHOD</b>	SILVAIR APP + IR REMOTE FOR RANGE SETTING
<b>REMOTE</b>	IR 12
<b>DAYLIGHT HARVESTING</b>	YES
<b>HI OR LOW TRIM</b>	YES
<b>BI-LEVEL DIMMING</b>	YES
<b>NETWORK TECHNOLOGY</b>	SILVAIR BLUETOOTH MESH
<b>INSTALLATION TYPE</b>	INTERNAL
<b>DLC LISTED</b>	YES + DLC NLC
<b>CONTROL CAPACITY</b>	10 FIXTURES

### IR12 REMOTE

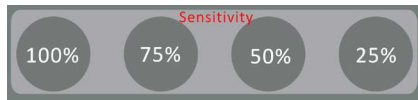

IR REMOTE FOR SENSITIVITY RANGE SETTING ONLY



FOR MORE INFO SCAN ABOVE

### SILVAIR APP

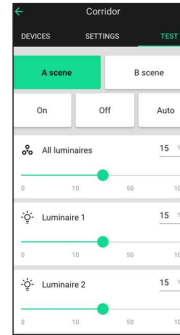

SILVAIR IS A SOFTWARE AND COMMISSIONING APP THAT CONNECTS AND CONTROLS LIGHTING FIXTURES USING BLUETOOTH MESH TECHNOLOGY.

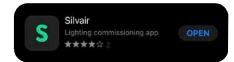

FOR MORE INFO SCAN ABOVE OR SEE PG. 21

### DETECTION PATTERN / RP-OCBT-HNB115MW

#### CEILING MOUNTING

##### DETECTION RANGE (FT)

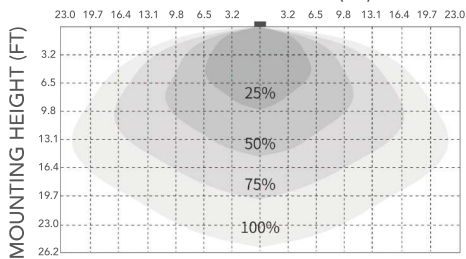

#### WALL MOUNTING

##### DETECTION DISTANCE (FT)

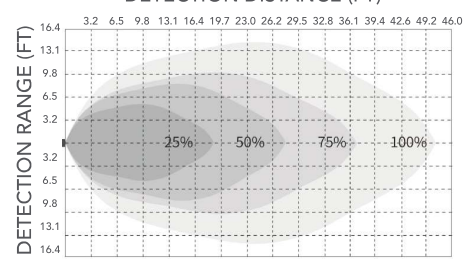

### DIMENSIONS / RC-OCBT-HNB115MW

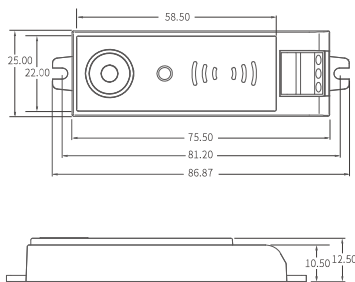

### WIRING DIAGRAM / RC-OCBT-HNB115MW

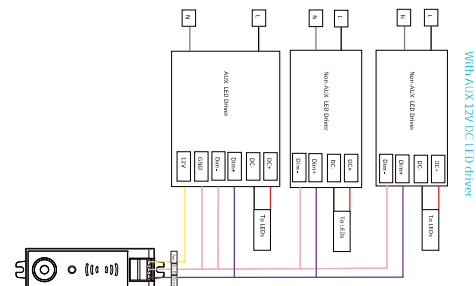



## SILVAIR-READY BLUETOOTH PASSIVE INFRARED EXTERNAL ARM SENSOR SENSOR

ORDERING / **RC-OCCBT-ARM-HNB178-PIR-BLE**, IN ADDITION TO THE LBE PART NUMBER, UPGRADES THE FIXTURE W/ A FACTORY INSTALLED **NETWORK LIGHTING CONTROL**. CONNECT THROUGH THE SILVAIR APP ON ROBUST BLUETOOTH MESH. CAN BE PAIRED W/ A SWITCH FOR WIRELESS DIMMING CONTROL OR CONNECT TO OTHER FIXTURES W/ SENSORS TO MAXIMIZE COST SAVINGS.



### ATTRIBUTES

<b>DETECTION TECHNOLOGY</b>	NONE
<b>DETECTION TYPE</b>	NONE
<b>SENSOR POWER</b>	12VDC
<b>GROUPABLE</b>	YES
<b>NETWORK LIGHTING CONTROL</b>	YES
<b>COMMISSIONING METHOD</b>	NONE
<b>REMOTE</b>	SILVAIR APP
<b>DAYLIGHT HARVESTING</b>	NO
<b>HI OR LOW TRIM</b>	YES
<b>BI-LEVEL DIMMING</b>	NO
<b>NETWORK TECHNOLOGY</b>	BLUETOOTH
<b>INSTALLATION TYPE</b>	INTERNAL
<b>DLC LISTED</b>	YES + DLC NLC

### SILVAIR APP

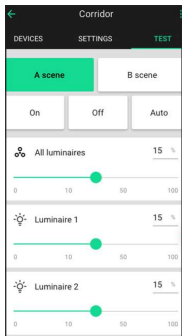

SILVAIR IS A SOFTWARE AND COMMISSIONING APP THAT CONNECTS AND CONTROLS LIGHTING FIXTURES USING BLUETOOTH MESH TECHNOLOGY.

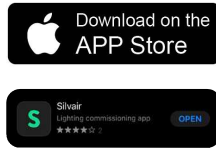

FOR MORE INFORMATION ON THE SILVAIR APP SCAN BELOW OR SEE PG. 21



### DETECTION PATTERN / RC-OCCBT-ARM-HNB178-PIR-BLE

#### CEILING MOUNTING

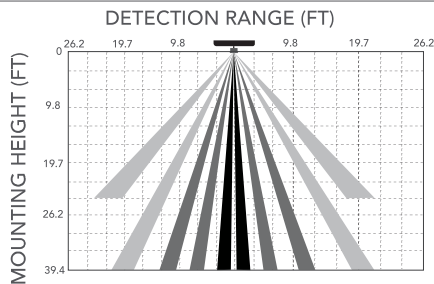

#### WALL MOUNTING

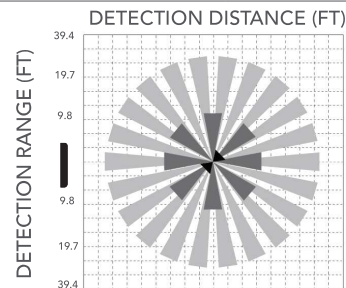

### ARM WIRING DIAGRAM

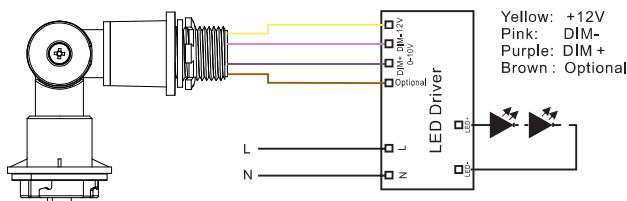

### ARM DIMENSIONS (IN)

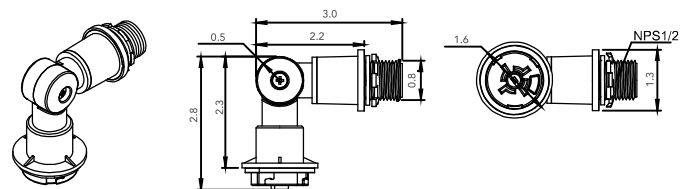



## SILVAIR-READY BLUETOOTH MICROWAVE AND DAYLIGHT HARVESTING OCCUPANCY SENSOR

ORDERING **RC-OCCBT-HNB131PIR**, IN ADDITION TO THE LBE PART NUMBER, UPGRADES THE FIXTURE W/ A FACTORY INSTALLED **NETWORK LIGHTING CONTROL**. ONCE CONNECTED THROUGH THE SILVAIR APP, THE BLUETOOTH PIR MOTION SENSOR AND DAYLIGHT HARVESTING TECHNOLOGY CAN MAXIMIZE ENERGY SAVINGS.



### ATTRIBUTES

<b>DETECTION TECHNOLOGY</b>	PASSIVE INFRARED (PIR)
<b>DETECTION TYPE</b>	OCCUPANCY / VACANCY
<b>SENSOR POWER</b>	12VDC
<b>GROUPABLE</b>	YES
<b>NETWORK LIGHTING CONTROL</b>	YES
<b>COMMISSIONING METHOD</b>	SILVAIR APP
<b>REMOTE</b>	IR 12
<b>DAYLIGHT HARVESTING</b>	YES
<b>HI OR LOW TRIM</b>	YES
<b>BI-LEVEL DIMMING</b>	YES
<b>NETWORK TECHNOLOGY</b>	BLUETOOTH
<b>INSTALLATION TYPE</b>	INTERNAL
<b>DLC LISTED</b>	YES + DLC NLC

### SILVAIR APP

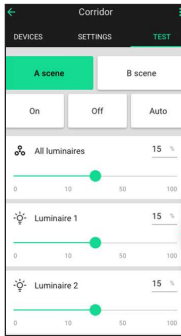

SILVAIR IS A SOFTWARE AND COMMISSIONING APP THAT CONNECTS AND CONTROLS LIGHTING FIXTURES USING BLUETOOTH MESH TECHNOLOGY.

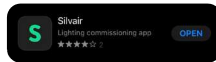

FOR MORE INFORMATION ON THE SILVAIR APP SCAN BELOW OR SEE PG. 21



### DETECTION PATTERN

#### TOP VIEW

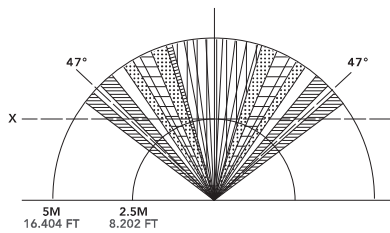

#### SIDE VIEW

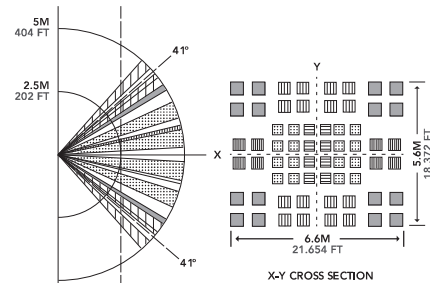

### WIRING DIAGRAM / RC-OCCBT-HNB131PIR

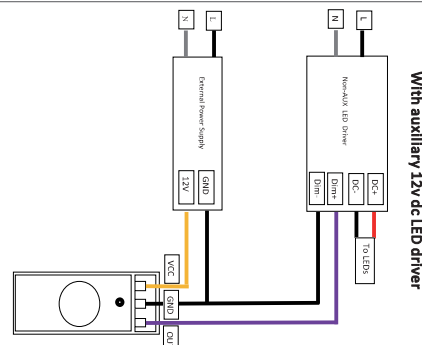



## SILVAIR-READY BLUETOOTH CONTROL NODE

ORDERING **RC-BT-HNB131CTL**, IN ADDITION TO THE LBE PART NUMBER, UPGRADES THE FIXTURE W/ A FACTORY INSTALLED **NETWORK LIGHTING CONTROL**. CONNECT THROUGH THE SILVAIR APP ON ROBUST BLUETOOTH MESH. CAN BE PAIRED W/ A SWITCH FOR WIRELESS DIMMING CONTROL OR CONNECT TO OTHER FIXTURES WITH SENSORS TO MAXIMIZE COST SAVINGS.



### ATTRIBUTES

<b>DETECTION TECHNOLOGY</b>	NONE
<b>DETECTION TYPE</b>	NONE
<b>SENSOR POWER</b>	12VDC
<b>GROUPABLE</b>	YES
<b>NETWORK LIGHTING CONTROL</b>	YES
<b>COMMISSIONING METHOD</b>	NONE
<b>REMOTE</b>	SILVAIR APP
<b>DAYLIGHT HARVESTING</b>	NO
<b>HI OR LOW TRIM</b>	YES
<b>BI-LEVEL DIMMING</b>	NO
<b>NETWORK TECHNOLOGY</b>	BLUETOOTH
<b>INSTALLATION TYPE</b>	INTERNAL
<b>DLC LISTED</b>	YES + DLC NLC

### SILVAIR APP

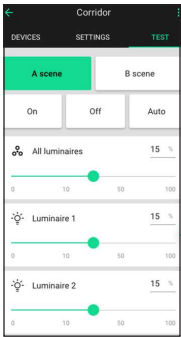

SILVAIR IS A SOFTWARE AND COMMISSIONING APP THAT CONNECTS AND CONTROLS LIGHTING FIXTURES USING BLUETOOTH MESH TECHNOLOGY.

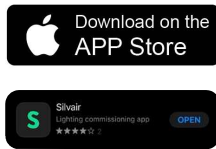

FOR MORE INFORMATION ON THE SILVAIR APP SCAN BELOW OR SEE PG. 21





## SILVAIR-READY BLUETOOTH NODE W/ EXTERNAL ANTENNA

ORDERING **RC-BTX-HNB136**, IN ADDITION TO THE LBE PART NUMBER, UPGRADES THE FIXTURE W/ A FACTORY INSTALLED **NETWORK LIGHTING CONTROL**. CONNECT THROUGH THE SILVAIR APP ON ROBUST BLUETOOTH MESH. CAN BE PAIRED W/ A SWITCH FOR WIRELESS DIMMING CONTROL OR CONNECT TO OTHER FIXTURES WITH SENSORS TO MAXIMIZE COST SAVINGS.



### ATTRIBUTES

<b>DETECTION TECHNOLOGY</b>	NONE
<b>DETECTION TYPE</b>	NONE
<b>SENSOR POWER</b>	12VDC
<b>GROUPABLE</b>	YES
<b>NETWORK LIGHTING CONTROL</b>	YES
<b>COMMISSIONING METHOD</b>	NONE
<b>REMOTE</b>	SILVAIR APP
<b>DAYLIGHT HARVESTING</b>	NO
<b>HI OR LOW TRIM</b>	YES
<b>BI-LEVEL DIMMING</b>	NO
<b>NETWORK TECHNOLOGY</b>	BLUETOOTH
<b>INSTALLATION TYPE</b>	INTERNAL
<b>DLC LISTED</b>	YES + DLC NLC

### SILVAIR APP

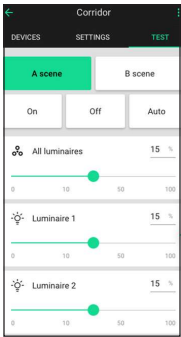

SILVAIR IS A SOFTWARE AND COMMISSIONING APP THAT CONNECTS AND CONTROLS LIGHTING FIXTURES USING BLUETOOTH MESH TECHNOLOGY.

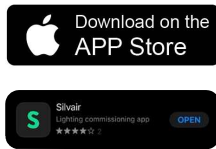

FOR MORE INFORMATION ON THE SILVAIR APP SCAN BELOW OR SEE PG. 21



# RemPhos SILVAIR APP + COMMISSIONING OVERVIEW

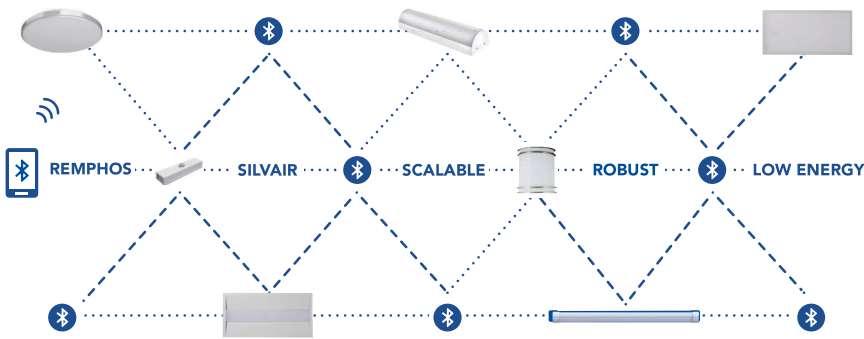

## WHAT IS SILVAIR?

Silvaair is a software and commissioning app that connects and controls lighting fixtures using Bluetooth mesh technology.

## HOW DOES IT CONNECT?

Silvaair can be set up in advance through the cloud and the Silvaair portal. It can also be commissioned in the field with the IOS app.

## DOWNLOAD SILVAIR APPS



MOBILE APP Apple App Store  
or  
WEB APP [platform.silvaair.com](http://platform.silvaair.com)

