



- Compatible Control Systems
 - Lutron EcoSystem Digital Control – dims down to 1%
 - Lutron 3-Wire Phase Control – dims down to 1%
 - Lutron DALI Digital – dims down to 1%
 - 0-10V – dims down to 5%
 - Line Voltage Dimming (LVD) – 5% (120V only for dimming)
- Available in two different sizes – 17-inch and 22-inch
- Simplest & safest option for substantial maintenance and energy savings
- Keep existing fixtures, sensors, and control system—no mess, no fixture recycling, and no need to break the ceiling plane
- Retrofit for over 50% less than installing a new fixture
- Optimize local utility rebates

RP-PLL



2G11

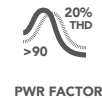
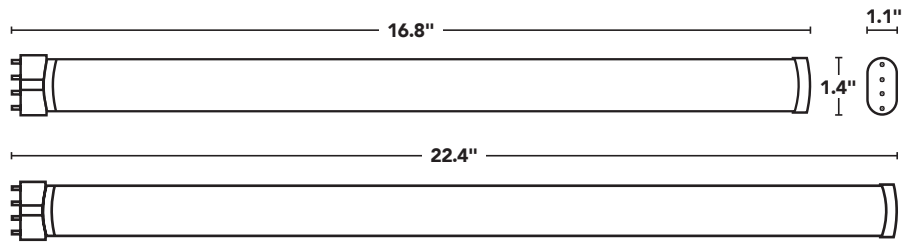

ETL CLASSIFIED



WHEN SEARCHING THE DLC QPL, USE QUOTATION MARKS AROUND OUR BRAND NAME OR PART # ("C-FLEX" OR "PLL-2.5K-1L-835-3W-M") OR VISIT OUR WEBSITE FOR A FILE THAT CONTAINS THE DLC PRODUCT ID.



PART NUMBER BUILDER

MFR	TYPE	#OF LAMPS	CCT	CONTROL INTERFACE	CASE	GEN	OPTIONS
RP	PLL					G2	
		17" --- 2.0K-1L 4.0K-2L 6.0K-3L 22" --- 2.5K-1L 5.0K-2L 7.5K-3L	830 = 3000K 835 = 3500K 840 = 4000K	E1 = LUTRON ECO SYSTEM (DIMS DOWN TO 1%) 3W = LUTRON 3-WIRE (DIMS DOWN TO 1%. 3 LAMP CONFIGURATION NOT AVAILABLE) DA = DALI DIGITAL (DIMS DOWN TO 1%) 10V = 0-10V DIMMING (DIMS DOWN TO 5%. KITS WITH M CASE DRIVER REQUIRE WATTAGE OPTION. SEE CONFIGURATION TABLE BELOW FOR SETTINGS) LVD = LINE VOLTAGE DIMMING (5% DIMMING TYPICAL. 120V/277V SWITCHED; 120V ONLY FOR DIMMING)	K = SQUARE W/ STUDS KN = SQUARE W/O STUDS M = LINEAR (SEE DIMENSIONS ON PG. 5)		-EMG -W SEE TABLE BELOW

EXAMPLE PART NUMBER RP-PLL-2.5K-1L-835-3W-M-G2-EMG

OPTIONS

EMG	W
EMERGENCY BATTERY BACKUP (See page 4 for more details)	SPECIFIC WATTAGE (Only required with 0-10V M-case driver option) See next page for wattage and lumen options

E1 DRIVER (PG. 5) W/ EMG CONFIGURATIONS (PG. 4)

PART #	LENGTH	# OF LAMPS	SYSTEM WATTAGE	SYSTEM LUMENS	EMG CONFIGURATION
RP-PLL-2.0K-1L-8XX-E1-C-G2	17"	1	20	2000	A
RP-PLL-4.0K-2L-8XX-E1-C-G2		2	40	4000	B
RP-PLL-6.0K-3L-8XX-E1-C-G2		3	60	6000	C
RP-PLL-2.5K-1L-8XX-E1-C-G2	22"	1	25	2500	A
RP-PLL-5.0K-2L-8XX-E1-C-G2		2	50	5000	B
RP-PLL-7.5K-3L-8XX-E1-C-G2		3	75	7500	C

3W DRIVER (PG. 5) W/ EMG CONFIGURATIONS (PG. 4)

PART #	LENGTH	# OF LAMPS	SYSTEM WATTAGE	SYSTEM LUMENS	EMG CONFIGURATION
RP-PLL-2.0K-1L-8XX-3W-C-G2	17"	1	20	2000	A
RP-PLL-4.0K-2L-8XX-3W-C-G2		2	40	4000	B
RP-PLL-2.5K-1L-8XX-3W-C-G2	22"	1	25	2500	A
RP-PLL-5.0K-2L-8XX-3W-C-G2		2	50	5000	B



LVD DRIVER (PG. 5) W/ EMG CONFIGURATIONS (PG. 4)

PART #	LENGTH	# OF LAMPS	SYSTEM WATTAGE	SYSTEM LUMENS	EMG CONFIGURATION
RP-PLL-4.0K-2L-8XX-LVD-M-G2	17"	2	40	4000	B
RP-PLL-4.0K-2L-8XX-LVD-K-G2	17"	2	40	4000	B
RP-PLL-2.0K-1L-8XX-LVD-KN-G2	17"	1	20	2000	A
RP-PLL-4.0K-2L-8XX-LVD-KN-G2		2	40	4000	B
RP-PLL-6.0K-3L-8XX-LVD-KN-G2		3	60	6000	C
RP-PLL-2.5K-1L-8XX-LVD-M-G2	22"	1	25	2500	A
RP-PLL-2.5K-1L-8XX-LVD-K-G2	22"	1	25	2500	A
RP-PLL-2.5K-1L-8XX-LVD-KN-G2	22"	1	25	2500	A
RP-PLL-5.0K-2L-8XX-LVD-KN-G2		2	50	5000	B
RP-PLL-7.5K-3L-8XX-LVD-KN-G2		3	68	6800	C

10V DRIVER (PG. 5) W/ EMG CONFIGURATIONS (PG. 4)

PART #	LENGTH	# OF LAMPS	SYSTEM WATTAGE	SYSTEM LUMENS	EMG CONFIGURATION
RP-PLL-2.0K-1L-8XX-10V-M-G2-18W	17"	1	18	1800	A
RP-PLL-4.0K-2L-8XX-10V-M-G2-35W		2	35	3500	B
RP-PLL-6.0K-3L-8XX-10V-M-G2-50W		3	50	5000	B
RP-PLL-2.0K-1L-8XX-10V-K-G2	17"	1	18	1800	A
RP-PLL-4.0K-2L-8XX-10V-K-G2		2	36	3600	B
RP-PLL-6.0K-3L-8XX-10V-K-G2		3	52	5200	B
RP-PLL-2.0K-1L-8XX-10V-KN-G2	17"	1	18	1800	A
RP-PLL-4.0K-2L-8XX-10V-KN-G2		2	36	3600	B
RP-PLL-6.0K-3L-8XX-10V-KN-G2		3	52	5200	B
RP-PLL-2.5K-1L-8XX-10V-M-G2-20W	22"	1	20	2000	A
RP-PLL-5.0K-2L-8XX-10V-M-G2-40W		2	40	4000	B
RP-PLL-7.5K-3L-8XX-10V-M-G2-60W		3	60	6000	C
RP-PLL-2.5K-1L-8XX-10V-K-G2	22"	1	25	2500	A
RP-PLL-5.0K-2L-8XX-10V-K-G2		2	50	5000	B
RP-PLL-7.5K-3L-8XX-10V-K-G2		3	64	6400	C
RP-PLL-2.5K-1L-8XX-10V-KN-G2	22"	1	25	2500	A
RP-PLL-5.0K-2L-8XX-10V-KN-G2		2	50	5000	B
RP-PLL-7.5K-3L-8XX-10V-KN-G2		3	64	6400	C



EMG CONFIGURATIONS

4W ALL-IN-ONE EMG [CONFIGURATION A]

EXISTING PLL LAMPS WILL LIGHT IN EMG MODE
Approximately 500 lumens for 90 minutes.
Contact us for more options

DRIVER



EMG DIMENSIONS: 5.34" x 1.69" x 1.01"
(SEE LINE DRAWING BELOW)
SEE EXAMPLE 1 BELOW FOR WIRING DIAGRAM

4W ALL-IN-ONE EMG W/ SEPARATE LIGHT ENGINE [CONFIGURATION B]

SEPARATE LIGHT ENGINE WILL LIGHT IN EMG MODE
Approximately 500 lumens for 90 minutes.
Contact us for more options

DRIVER



LIGHT ENGINE



EMG DIMENSIONS: 5.34" x 1.69" x 1.01"
(SEE LINE DRAWING BELOW)
LIGHT ENGINE DIMENSIONS: 4.7" x .83" x .04"
SEE EXAMPLE 2 BELOW FOR WIRING DIAGRAM

8W EMG DRIVER, SEPARATE BATTERY & LIGHT ENGINE [CONFIGURATION C]

SEPARATE LIGHT ENGINE WILL LIGHT IN EMG MODE
Approximately 1000 lumens for 90 minutes.
Contact us for more options

DRIVER + LIGHT ENGINE



EMG DIMENSIONS: 5.34" x 1.69" x 1.01"
(SEE LINE DRAWING BELOW)
LIGHT ENGINE DIMENSIONS: 4.7" x .83" x .04"
BATTERY DIMENSIONS: 3.48" x 2.76" x .99"
(SEE LINE DRAWING BELOW)

EMG

USED FOR ALL EMG KITS

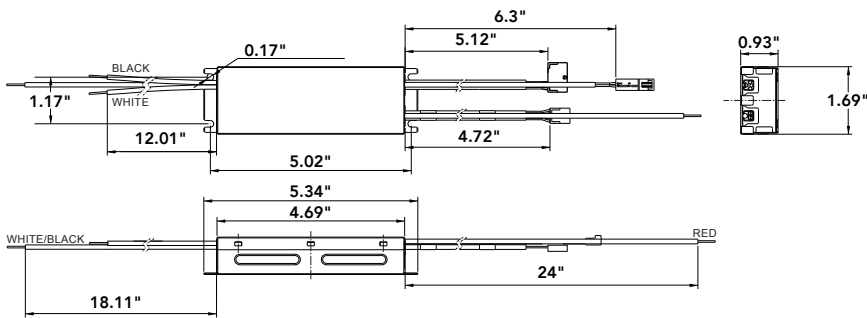

EXTERNAL EMG

USED FOR RP-EM-SKB-1000LM/90-4.7X.8-8W

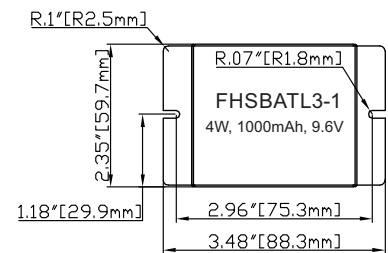

WIRING DIAGRAMS

CONFIGURATION A

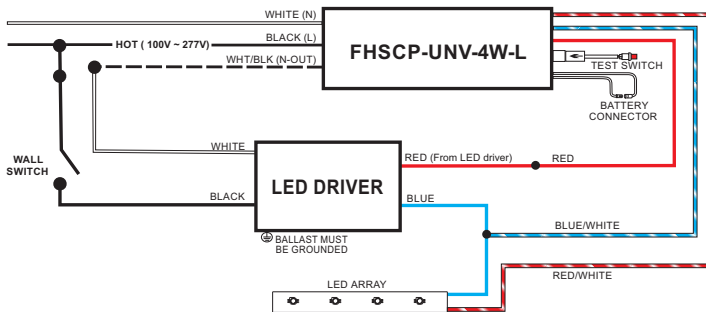

CONFIGURATION B & C

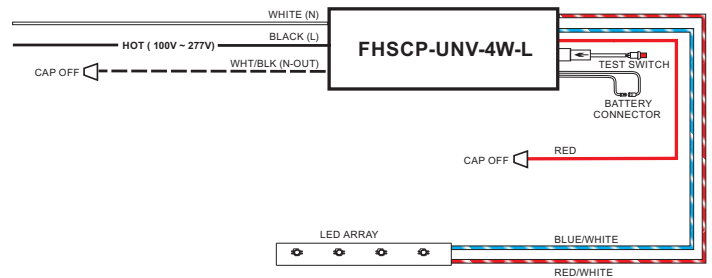



DRIVER DIMENSIONS

LUTRON



CASE TYPE K

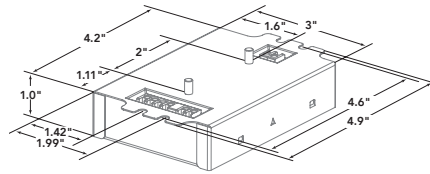

K CASE CONNECTOR LOCATIONS (WITH STUDS)

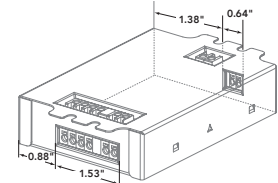

KN CASE SIDE ENTRY CONNECTOR LOCATIONS (WITHOUT STUDS)



CASE TYPE M

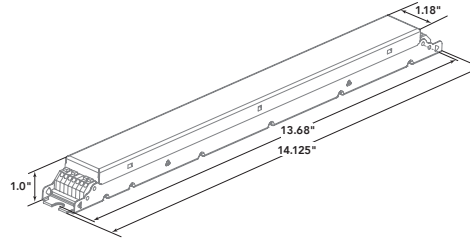

LVD



M CASE

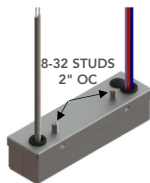

K CASE

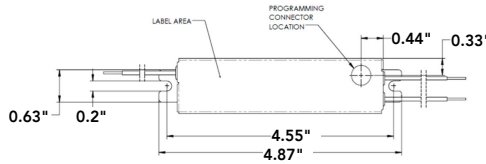

M CASE

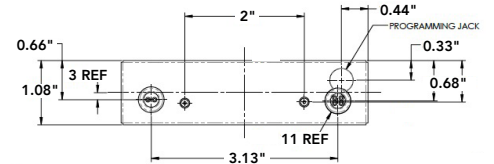

K CASE



KN CASE
25W SYSTEM MAX



KN CASE
26W-60W SYSTEM MAX

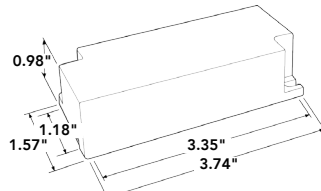

KN CASE 25W SYSTEM MAX

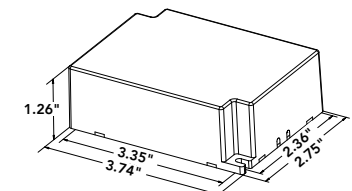

KN CASE 26W-60W SYSTEM WATTAGE

NOTE IT IS IMPORTANT THAT LVD DRIVERS ARE MOUNTED TO A FLAT SURFACE IN ORDER TO MAXIMIZE SERVICE LIFE

10V

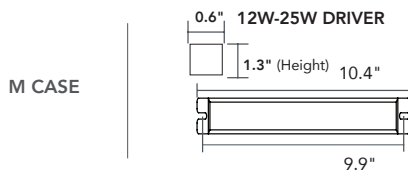

M CASE

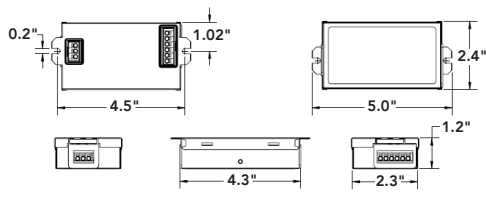
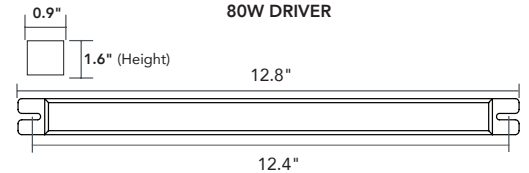
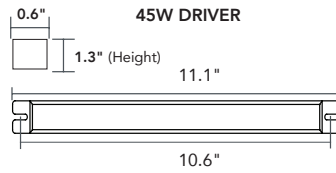

KN CASE

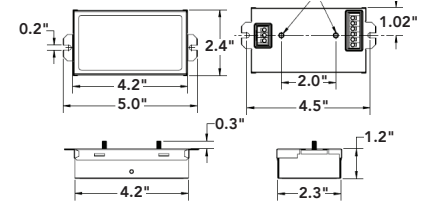

K CASE



MOST COMMON FIXTURE TYPES

CEILING / TROFFER



2-LAMP DOWNLIGHT ORIENTATION

PENDANT



1 OR 2-LAMP UPLIGHT/DOWNLIGHT ORIENTATION

SCONCE



1 OR 2-LAMP VERTICAL ORIENTATION



FOR MORE INFORMATION VISIT C-FLEXRETROFITS.COM OR CONTACT US