



- Compatible Control Systems
 - Lutron EcoSystem Digital Control – dims down to 1%
 - Lutron 3-Wire Phase Control – dims down to 1%
 - Lutron DALI Digital – dims down to 1%
 - 0-10V – dims down to 5%
 - Line Voltage Dimming (LVD) – 5% (120V only for dimming)
- Simplest & safest option for substantial maintenance and energy savings
- Keep existing fixtures, sensors, and control system—no mess, no fixture recycling, and no need to break the ceiling plane
- Retrofit for over 50% less than installing a new fixture
- Optimize local utility rebates

GLASS TUBE W/
ALUMINUM END CAP



ETL CLASSIFIED



WHEN SEARCHING THE DLC QPL, USE QUOTATION MARKS AROUND OUR BRAND NAME OR PART # ("C-FLEX" OR "RP-T8-4FT-1L-830-10V-M-G2-10W") OR VISIT OUR WEBSITE FOR A FILE THAT CONTAINS THE DLC PRODUCT ID.



PART NUMBER BUILDER

MFR	TYPE	LENGTH	# OF LAMPS	CCT	CONTROL INTERFACE*	CASE (C)	GEN	OPTIONS
RP							G2	
	T8LO	2FT	1L	830 = 3000K	E1 = LUTRON ECO SYSTEM (DIMS DOWN TO 1%)	K = SQUARE W/ STUDS		-BMF -EMG -W
	T8HO	3FT	2L	835 = 3500K	3W = LUTRON 3-WIRE (DIMS DOWN TO 1%)	KN = SQUARE W/O STUDS		
	T8	4FT	3L	840 = 4000K	10V = 0-10V DIMMING (DIMS DOWN TO 5%. KITS W/ M CASE DRIVER REQUIRE WATTAGE OPTION. SEE CONFIGURATION TABLE BELOW FOR SETTINGS)	M = LINEAR		SEE TABLE BELOW
	T5		4L	850 = 5000K	LVD = LINE VOLTAGE DIMMING (5% DIMMING TYPICAL. 120V/277V SWITCHED; 120V ONLY FOR DIMMING)	(SEE DIMENSIONS ON LAST PAGE)		
	T5HO				DA = DALI DIGITAL (DEFAULT DRIVER SETTINGS: CONTROL OUTPUT ENABLED, LOGARITHMIC DIMMING, 1% DIMMING LEVEL. CONTACT US IF DIFFERENT SETTINGS ARE REQUIRED)			
					*CONTACT US FOR ADDITIONAL CONTROL OPTIONS			

EXAMPLE PART NUMBER RP-T8-4FT-1L-830-10V-M-G2-EMG

OPTIONS

BMF	EMG	W
<p>ECOSYSTEM BALLAST MODULE Must specify 3W control only. Used only if EC5 ballast had sensors connected.</p> 	<p>EMERGENCY BATTERY BACKUP (See page 8 for more details)</p>	<p>SPECIFIC WATTAGE (Only required with 0-10V M-case driver option)</p>

E1 DRIVER (PG. 9) W/ EMG CONFIGURATIONS (PG. 8)

PART #	LAMPS PER DRIVER	SYSTEM WATTAGE	SYSTEM LUMENS	EMG CONFIGURATION
RP-T5-2FT-1L-8XX-E1-C-G2	1	13	1430	A
RP-T5-2FT-2L-8XX-E1-C-G2	2	25	2750	A
RP-T5-2FT-3L-8XX-E1-C-G2	3	38	4180	A
RP-T5-3FT-1L-8XX-E1-C-G2	1	13	1430	A
RP-T5-3FT-2L-8XX-E1-C-G2	2	25	2750	A
RP-T5-3FT-3L-8XX-E1-C-G2	3	38	4180	A
RP-T5-4FT-1L-8XX-E1-C-G2	1	19	2090	A
RP-T5-4FT-2L-8XX-E1-C-G2	2	37	4070	A
RP-T5-4FT-3L-8XX-E1-C-G2	3	55	6050	B
RP-T5HO-2FT-1L-8XX-E1-C-G2	1	15	1650	A
RP-T5HO-2FT-2L-8XX-E1-C-G2	2	29	3190	A
RP-T5HO-2FT-3L-8XX-E1-C-G2	3	44	4840	B
RP-T5HO-3FT-1L-8XX-E1-C-G2	1	15	1650	A
RP-T5HO-3FT-2L-8XX-E1-C-G2	2	29	3190	A
RP-T5HO-3FT-3L-8XX-E1-C-G2	3	44	4840	B
RP-T5HO-4FT-1L-8XX-E1-C-G2	1	29	3190	A
RP-T5HO-4FT-2L-8XX-E1-C-G2	2	58	6380	B
RP-T5HO-4FT-3L-8XX-E1-C-G2	3	87	9570	C
RP-T8LO-4FT-1L-8XX-E1-C-G2	1	17	1870	A
RP-T8LO-4FT-2L-8XX-E1-C-G2	2	29	3190	A
RP-T8LO-4FT-3L-8XX-E1-C-G2	3	41	4510	B
RP-T8LO-4FT-4L-8XX-E1-C-G2	4	56	6160	B
RP-T8-2FT-1L-8XX-E1-C-G2	1	12	1320	A
RP-T8-2FT-2L-8XX-E1-C-G2	2	18	1980	A
RP-T8-2FT-3L-8XX-E1-C-G2	3	28	3080	A
RP-T8-2FT-4L-8XX-E1-C-G2	4	38	4180	B
RP-T8-3FT-1L-8XX-E1-C-G2	1	12	1320	A
RP-T8-3FT-2L-8XX-E1-C-G2	2	18	1980	A
RP-T8-3FT-3L-8XX-E1-C-G2	3	28	3080	B
RP-T8-3FT-4L-8XX-E1-C-G2	4	38	4180	B
RP-T8-4FT-1L-8XX-E1-C-G2	1	18	1980	A
RP-T8-4FT-2L-8XX-E1-C-G2	2	35	3850	A
RP-T8-4FT-3L-8XX-E1-C-G2	3	53	5830	B
RP-T8-4FT-4L-8XX-E1-C-G2	4	71	7810	B
RP-T8HO-4FT-1L-8XX-E1-C-G2	1	28	3080	A
RP-T8HO-4FT-2L-8XX-E1-C-G2	2	51	5610	B
RP-T8HO-4FT-3L-8XX-E1-C-G2	3	74	8140	C



3W DRIVER (PG. 9) W/ EMG CONFIGURATIONS (PG. 8)

PART #	LAMPS PER DRIVER	SYSTEM WATTAGE	SYSTEM LUMENS	EMG CONFIGURATION
RP-T5-2FT-1L-8XX-3W-C-G2	1	13	1430	A
RP-T5-2FT-2L-8XX-3W-C-G2	2	25	2750	A
RP-T5-2FT-3L-8XX-3W-C-G2	3	38	4180	A
RP-T5-3FT-1L-8XX-3W-C-G2	1	13	1430	A
RP-T5-3FT-2L-8XX-3W-C-G2	2	25	2750	A
RP-T5-3FT-3L-8XX-3W-C-G2	3	38	4180	A
RP-T5-4FT-1L-8XX-3W-C-G2	1	19	2090	A
RP-T5-4FT-2L-8XX-3W-C-G2	2	37	4070	A
RP-T5-4FT-3L-8XX-3W-C-G2	3	48	5280	B
RP-T5HO-2FT-1L-8XX-3W-C-G2	1	15	1650	A
RP-T5HO-2FT-2L-8XX-3W-C-G2	2	29	3190	A
RP-T5HO-2FT-3L-8XX-3W-C-G2	3	44	4840	B
RP-T5HO-3FT-1L-8XX-3W-C-G2	1	15	1650	A
RP-T5HO-3FT-2L-8XX-3W-C-G2	2	29	3190	A
RP-T5HO-3FT-3L-8XX-3W-C-G2	3	44	4840	B
RP-T5HO-4FT-1L-8XX-3W-C-G2	1	29	3190	A
RP-T5HO-4FT-2L-8XX-3W-C-G2	2	48	5280	B
<hr/>				
RP-T8LO-4FT-1L-8XX-3W-C-G2	1	17	1870	A
RP-T8LO-4FT-2L-8XX-3W-C-G2	2	29	3190	A
RP-T8LO-4FT-3L-8XX-3W-C-G2	3	41	4510	B
RP-T8-2FT-1L-8XX-3W-C-G2	1	13	1430	A
RP-T8-2FT-2L-8XX-3W-C-G2	2	18	1980	A
RP-T8-2FT-3L-8XX-3W-C-G2	3	28	3080	A
RP-T8-2FT-4L-8XX-3W-C-G2	4	38	4180	B
RP-T8-3FT-1L-8XX-3W-C-G2	1	12	1320	A
RP-T8-3FT-2L-8XX-3W-C-G2	2	18	1980	A
RP-T8-3FT-3L-8XX-3W-C-G2	3	28	3080	B
RP-T8-3FT-4L-8XX-3W-C-G2	4	38	4180	B
RP-T8-4FT-1L-8XX-3W-C-G2	1	18	1980	A
RP-T8-4FT-2L-8XX-3W-C-G2	2	35	3850	A
RP-T8-4FT-3L-8XX-3W-C-G2	3	48	5280	B
RP-T8HO-4FT-1L-8XX-3W-C-G2	1	28	3080	A
RP-T8HO-4FT-2L-8XX-3W-C-G2	2	48	5280	B

LVD-KN DRIVER (PG. 9) W/ EMG CONFIGURATIONS (PG. 8)

PART #	LAMPS PER DRIVER	SYSTEM WATTAGE	SYSTEM LUMENS	EMG CONFIGURATION
RP-T5-2FT-1L-8XX-LVD-KN-G2	1	11	1210	A
RP-T5-2FT-2L-8XX-LVD-KN-G2	2	22	2420	A
RP-T5-2FT-3L-8XX-LVD-KN-G2	3	33	3630	A
RP-T5-3FT-1L-8XX-LVD-KN-G2	1	11	1210	A
RP-T5-3FT-2L-8XX-LVD-KN-G2	2	22	2420	A
RP-T5-3FT-3L-8XX-LVD-KN-G2	3	33	3630	A
RP-T5-4FT-1L-8XX-LVD-KN-G2	1	19	2090	A
RP-T5-4FT-2L-8XX-LVD-KN-G2	2	37	4070	A
RP-T5-4FT-3L-8XX-LVD-KN-G2	3	55	6050	B
RP-T5HO-2FT-1L-8XX-LVD-KN-G2	1	15	1650	A
RP-T5HO-2FT-2L-8XX-LVD-KN-G2	2	29	3190	A
RP-T5HO-2FT-3L-8XX-LVD-KN-G2	3	42	4620	B
RP-T5HO-3FT-1L-8XX-LVD-KN-G2	1	15	1650	A
RP-T5HO-3FT-2L-8XX-LVD-KN-G2	2	29	3190	A
RP-T5HO-3FT-3L-8XX-LVD-KN-G2	3	42	4620	B
RP-T5HO-4FT-1L-8XX-LVD-KN-G2	1	29	3190	A
RP-T5HO-4FT-2L-8XX-LVD-KN-G2	2	58	6380	B
<hr/>				
RP-T5HO-4FT-3L-8XX-LVD-KN-G2	3	69	7590	C
RP-T8LO-4FT-1L-8XX-LVD-KN-G2	1	13	1430	A
RP-T8LO-4FT-2L-8XX-LVD-KN-G2	2	26	2860	A
RP-T8LO-4FT-3L-8XX-LVD-KN-G2	3	38	4180	B
RP-T8LO-4FT-4L-8XX-LVD-KN-G2	4	56	6160	B
RP-T8-2FT-1L-8XX-LVD-KN-G2	1	12	1320	A
RP-T8-2FT-2L-8XX-LVD-KN-G2	2	18	1980	A
RP-T8-2FT-3L-8XX-LVD-KN-G2	3	28	3080	A
RP-T8-2FT-4L-8XX-LVD-KN-G2	4	38	4180	B
RP-T8-3FT-1L-8XX-LVD-KN-G2	1	12	1320	A
RP-T8-3FT-2L-8XX-LVD-KN-G2	2	18	1980	A
RP-T8-3FT-3L-8XX-LVD-KN-G2	3	28	3080	B
RP-T8-3FT-4L-8XX-LVD-KN-G2	4	38	4180	B
RP-T8-4FT-1L-8XX-LVD-KN-G2	1	19	2090	A
RP-T8-4FT-2L-8XX-LVD-KN-G2	2	37	4070	A
RP-T8-4FT-3L-8XX-LVD-KN-G2	3	55	6050	B
RP-T8-4FT-4L-8XX-LVD-KN-G2	4	71	7810	B
RP-T8HO-4FT-1L-8XX-LVD-KN-G2	1	27	2970	A
RP-T8HO-4FT-2L-8XX-LVD-KN-G2	2	53	5830	B
RP-T8HO-4FT-3L-8XX-LVD-KN-G2	3	69	7590	C



LVD-M AND K DRIVER* (PG. 9) W/ EMG CONFIGURATIONS (PG. 8)

PART #	LAMPS PER DRIVER	SYSTEM WATTAGE	SYSTEM LUMENS	EMG CONFIGURATION
RP-T5-2FT-2L-8XX-LVD-C-G2	2	22	2420	A
RP-T5-2FT-3L-8XX-LVD-C-G2	3	33	3630	A
RP-T5-3FT-2L-8XX-LVD-C-G2	2	22	2420	A
RP-T5-3FT-3L-8XX-LVD-C-G2	3	33	3630	A
RP-T5-4FT-2L-8XX-LVD-C-G2	2	37	4070	A
RP-T5HO-2FT-2L-8XX-LVD-C-G2	2	29	3190	A
RP-T5HO-2FT-3L-8XX-LVD-C-G2	3	42	4620	B
RP-T5HO-3FT-2L-8XX-LVD-C-G2	2	29	3190	A
RP-T5HO-3FT-3L-8XX-LVD-C-G2	3	42	4620	B
RP-T5HO-4FT-1L-8XX-LVD-C-G2	1	29	3190	A
<hr/>				
RP-T8LO-4FT-2L-8XX-LVD-C-G2	2	26	2860	A
RP-T8LO-4FT-3L-8XX-LVD-C-G2	3	38	4180	B
RP-T8-2FT-3L-8XX-LVD-C-G2	3	28	3080	A
RP-T8-2FT-4L-8XX-LVD-C-G2	4	38	4180	B
RP-T8-3FT-2L-8XX-LVD-C-G2	2	18	1980	A
RP-T8-3FT-3L-8XX-LVD-C-G2	3	28	3080	B
RP-T8-4FT-2L-8XX-LVD-C-G2	2	37	4070	A
RP-T8HO-4FT-1L-8XX-LVD-C-G2	1	27	2970	A

*REPLACE "C" WITH M OR K IN ORDER TO SPECIFY DRIVE CASE TYPE

10V-M DRIVER (PG. 9) W/ EMG CONFIGURATIONS (PG. 8)

PART #	LAMPS PER DRIVER	SYSTEM WATTAGE	SYSTEM LUMENS	EMG CONFIGURATION
RP-T5-2FT-1L-8XX-10V-M-G2-6W	1	6	660	A
RP-T5-3FT-1L-8XX-10V-M-G2-6W	1	6	660	A
RP-T5-4FT-1L-8XX-10V-M-G2-6W	1	6	660	A
<hr/>				
RP-T8-2FT-1L-8XX-10V-M-G2-6W	1	6	660	A
RP-T8-3FT-1L-8XX-10V-M-G2-6W	1	6	660	A
RP-T8-4FT-1L-8XX-10V-M-G2-6W	1	6	660	A
<hr/>				
RP-T5-2FT-1L-8XX-10V-M-G2-8W	1	8	880	A
RP-T5-3FT-1L-8XX-10V-M-G2-8W	1	8	880	A
RP-T5-4FT-1L-8XX-10V-M-G2-8W	1	8	880	A
<hr/>				
RP-T8-2FT-1L-8XX-10V-M-G2-8W	1	8	880	A
RP-T8-3FT-1L-8XX-10V-M-G2-8W	1	8	880	A
RP-T8-4FT-1L-8XX-10V-M-G2-8W	1	8	880	A
<hr/>				
RP-T5-2FT-1L-8XX-10V-M-G2-10W	1	10	1100	A
RP-T5-2FT-2L-8XX-10V-M-G2-10W	2	10	1100	A
RP-T5-3FT-1L-8XX-10V-M-G2-10W	1	10	1100	A
RP-T5-4FT-1L-8XX-10V-M-G2-10W	1	10	1100	A
<hr/>				
RP-T8-2FT-1L-8XX-10V-M-G2-10W	1	10	1100	A
RP-T8-2FT-2L-8XX-10V-M-G2-10W	2	10	1100	A
RP-T8-3FT-1L-8XX-10V-M-G2-10W	1	10	1100	A
RP-T8-4FT-1L-8XX-10V-M-G2-10W	1	10	1100	A
<hr/>				
RP-T5-2FT-1L-8XX-10V-M-G2-12W	1	12	1320	A
RP-T5-2FT-2L-8XX-10V-M-G2-12W	2	12	1320	A
RP-T5-2FT-3L-8XX-10V-M-G2-12W	3	12	1320	A
RP-T5-3FT-1L-8XX-10V-M-G2-12W	1	12	1320	A
RP-T5-3FT-2L-8XX-10V-M-G2-12W	2	12	1320	A
RP-T5-4FT-1L-8XX-10V-M-G2-12W	1	12	1320	A
RP-T5-4FT-2L-8XX-10V-M-G2-12W	2	12	1320	A
<hr/>				
RP-T8-2FT-2L-8XX-10V-M-G2-12W	2	12	1320	A
RP-T8-2FT-3L-8XX-10V-M-G2-12W	3	12	1320	A
RP-T8-3FT-1L-8XX-10V-M-G2-12W	1	12	1320	A
RP-T8-3FT-2L-8XX-10V-M-G2-12W	2	12	1320	A
RP-T8-4FT-1L-8XX-10V-M-G2-12W	1	12	1320	A
RP-T8-4FT-2L-8XX-10V-M-G2-12W	2	12	1320	A
<hr/>				
RP-T5-2FT-1L-8XX-10V-M-G2-15W	1	15	1650	A
RP-T5-2FT-2L-8XX-10V-M-G2-15W	2	15	1650	A
RP-T5-2FT-3L-8XX-10V-M-G2-15W	3	15	1650	A
RP-T5-3FT-1L-8XX-10V-M-G2-15W	1	15	1650	A
RP-T5-3FT-2L-8XX-10V-M-G2-15W	2	15	1650	A
RP-T5-3FT-3L-8XX-10V-M-G2-15W	3	15	1650	A
RP-T5-4FT-1L-8XX-10V-M-G2-15W	1	15	1650	A
RP-T5-4FT-2L-8XX-10V-M-G2-15W	2	15	1650	A
<hr/>				
RP-T8-2FT-2L-8XX-10V-M-G2-15W	2	15	1650	A
RP-T8-2FT-3L-8XX-10V-M-G2-15W	3	15	1650	A
RP-T8-3FT-2L-8XX-10V-M-G2-15W	2	15	1650	A
RP-T8-3FT-3L-8XX-10V-M-G2-15W	3	15	1650	A
RP-T8-4FT-1L-8XX-10V-M-G2-15W	1	15	1650	A
RP-T8-4FT-2L-8XX-10V-M-G2-15W	2	15	1650	A



10V-M DRIVER (PG. 9) W/ EMG CONFIGURATIONS (PG. 8)

PART #	LAMPS PER DRIVER	SYSTEM WATTAGE	SYSTEM LUMENS	EMG CONFIGURATION
RP-T5-2FT-2L-8XX-10V-M-G2-18W	2	18	1980	A
RP-T5-2FT-3L-8XX-10V-M-G2-18W	3	18	1980	A
RP-T5-2FT-4L-8XX-10V-M-G2-18W	4	18	1980	A
RP-T5-3FT-2L-8XX-10V-M-G2-18W	2	18	1980	A
RP-T5-3FT-3L-8XX-10V-M-G2-18W	3	18	1980	A
RP-T5-3FT-4L-8XX-10V-M-G2-18W	4	18	1980	A
RP-T5-4FT-1L-8XX-10V-M-G2-18W	1	18	1980	A
RP-T5-4FT-2L-8XX-10V-M-G2-18W	2	18	1980	A
RP-T5-4FT-3L-8XX-10V-M-G2-18W	3	18	1980	A
RP-T8-2FT-2L-8XX-10V-M-G2-18W	2	18	1980	A
RP-T8-2FT-3L-8XX-10V-M-G2-18W	3	18	1980	A
RP-T8-2FT-4L-8XX-10V-M-G2-18W	4	18	1980	A
RP-T8-3FT-2L-8XX-10V-M-G2-18W	2	18	1980	A
RP-T8-3FT-3L-8XX-10V-M-G2-18W	3	18	1980	A
RP-T8-3FT-4L-8XX-10V-M-G2-18W	4	18	1980	A
RP-T8-4FT-1L-8XX-10V-M-G2-18W	1	18	1980	A
RP-T8-4FT-2L-8XX-10V-M-G2-18W	2	18	1980	A
RP-T8-4FT-3L-8XX-10V-M-G2-18W	3	18	1980	A
RP-T5-2FT-2L-8XX-10V-M-G2-20W	2	20	2200	A
RP-T5-2FT-3L-8XX-10V-M-G2-20W	3	20	2200	A
RP-T5-2FT-4L-8XX-10V-M-G2-20W	4	20	2200	A
RP-T5-3FT-2L-8XX-10V-M-G2-20W	2	20	2200	A
RP-T5-3FT-3L-8XX-10V-M-G2-20W	3	20	2200	A
RP-T5-3FT-4L-8XX-10V-M-G2-20W	4	20	2200	A
RP-T5-4FT-1L-8XX-10V-M-G2-20W	1	20	2200	A
RP-T5-4FT-2L-8XX-10V-M-G2-20W	2	20	2200	A
RP-T5-4FT-3L-8XX-10V-M-G2-20W	3	20	2200	A
RP-T8-2FT-2L-8XX-10V-M-G2-20W	2	20	2200	A
RP-T8-2FT-3L-8XX-10V-M-G2-20W	3	20	2200	A
RP-T8-2FT-4L-8XX-10V-M-G2-20W	4	20	2200	A
RP-T8-3FT-2L-8XX-10V-M-G2-20W	2	20	2200	A
RP-T8-3FT-3L-8XX-10V-M-G2-20W	3	20	2200	A
RP-T8-3FT-4L-8XX-10V-M-G2-20W	4	20	2200	A
RP-T8-4FT-1L-8XX-10V-M-G2-20W	1	20	2200	A
RP-T8-4FT-2L-8XX-10V-M-G2-20W	2	20	2200	A
RP-T8-4FT-3L-8XX-10V-M-G2-20W	3	20	2200	A
RP-T5-2FT-2L-8XX-10V-M-G2-25W	2	25	2750	A
RP-T5-2FT-3L-8XX-10V-M-G2-25W	3	25	2750	A
RP-T5-2FT-4L-8XX-10V-M-G2-25W	4	25	2750	A
RP-T5-3FT-2L-8XX-10V-M-G2-25W	2	25	2750	A
RP-T5-3FT-3L-8XX-10V-M-G2-25W	3	25	2750	A
RP-T5-3FT-4L-8XX-10V-M-G2-25W	4	25	2750	A
RP-T5-4FT-2L-8XX-10V-M-G2-25W	2	25	2750	A
RP-T5-4FT-3L-8XX-10V-M-G2-25W	3	25	2750	A
RP-T5-4FT-4L-8XX-10V-M-G2-25W	4	25	2750	A
RP-T5HO-4FT-1L-8XX-10V-M-G2-25W	1	25	2750	A
RP-T8-2FT-3L-8XX-10V-M-G2-25W	3	25	2750	A
RP-T8-2FT-4L-8XX-10V-M-G2-25W	4	25	2750	A
RP-T8-3FT-2L-8XX-10V-M-G2-25W	2	25	2750	A
RP-T8-3FT-3L-8XX-10V-M-G2-25W	3	25	2750	A
RP-T8-3FT-4L-8XX-10V-M-G2-25W	4	25	2750	A
RP-T8-4FT-1L-8XX-10V-M-G2-25W	1	25	2750	A
RP-T8-4FT-2L-8XX-10V-M-G2-25W	2	25	2750	A
RP-T8-4FT-3L-8XX-10V-M-G2-25W	3	25	2750	A
RP-T8-4FT-4L-8XX-10V-M-G2-25W	4	25	2750	A
RP-T5-2FT-3L-8XX-10V-M-G2-30W	3	30	3300	A
RP-T5-2FT-4L-8XX-10V-M-G2-30W	4	30	3300	A
RP-T5-3FT-3L-8XX-10V-M-G2-30W	3	30	3300	A
RP-T5-3FT-4L-8XX-10V-M-G2-30W	4	30	3300	A
RP-T5-4FT-2L-8XX-10V-M-G2-30W	2	30	3300	A
RP-T5-4FT-3L-8XX-10V-M-G2-30W	3	30	3300	A
RP-T5-4FT-4L-8XX-10V-M-G2-30W	4	30	3300	A
RP-T8-2FT-3L-8XX-10V-M-G2-30W	3	30	3300	A
RP-T8-2FT-4L-8XX-10V-M-G2-30W	4	30	3300	A
RP-T8-3FT-3L-8XX-10V-M-G2-30W	3	30	3300	A
RP-T8-3FT-4L-8XX-10V-M-G2-30W	4	30	3300	A
RP-T8-4FT-2L-8XX-10V-M-G2-30W	2	30	3300	A
RP-T8-4FT-3L-8XX-10V-M-G2-30W	3	30	3300	A
RP-T8-4FT-4L-8XX-10V-M-G2-30W	4	30	3300	A



10V-M DRIVER (PG. 9) W/ EMG CONFIGURATIONS (PG. 8)

PART #	LAMPS PER DRIVER	SYSTEM WATTAGE	SYSTEM LUMENS	EMG CONFIGURATION
RP-T5-2FT-3L-8XX-10V-M-G2-35W	3	35	3850	A
RP-T5-2FT-4L-8XX-10V-M-G2-35W	4	35	3850	A
RP-T5-3FT-3L-8XX-10V-M-G2-35W	3	35	3850	A
RP-T5-3FT-4L-8XX-10V-M-G2-35W	4	35	3850	A
RP-T5-4FT-2L-8XX-10V-M-G2-35W	2	35	3850	A
RP-T5-4FT-3L-8XX-10V-M-G2-35W	3	35	3850	A
RP-T5-4FT-4L-8XX-10V-M-G2-35W	4	35	3850	A
RP-T8-2FT-4L-8XX-10V-M-G2-35W	4	35	3850	A
RP-T8-3FT-3L-8XX-10V-M-G2-35W	3	35	3850	A
RP-T8-3FT-4L-8XX-10V-M-G2-35W	4	35	3850	A
RP-T8-4FT-2L-8XX-10V-M-G2-35W	2	35	3850	A
RP-T8-4FT-3L-8XX-10V-M-G2-35W	3	35	3850	A
RP-T8-4FT-4L-8XX-10V-M-G2-35W	4	35	3850	A
RP-T5-2FT-4L-8XX-10V-M-G2-40W	4	40	4400	B
RP-T5-3FT-4L-8XX-10V-M-G2-40W	4	40	4400	B
RP-T5-4FT-2L-8XX-10V-M-G2-40W	2	40	4400	B
RP-T5-4FT-3L-8XX-10V-M-G2-40W	3	40	4400	B
RP-T5-4FT-4L-8XX-10V-M-G2-40W	4	40	4400	B
RP-T8-2FT-4L-8XX-10V-M-G2-40W	4	40	4400	B
RP-T8-3FT-4L-8XX-10V-M-G2-40W	4	40	4400	B
RP-T8-4FT-2L-8XX-10V-M-G2-40W	2	40	4400	B
RP-T8-4FT-3L-8XX-10V-M-G2-40W	3	40	4400	B
RP-T8-4FT-4L-8XX-10V-M-G2-40W	4	40	4400	B
RP-T5-2FT-4L-8XX-10V-M-G2-45W	4	45	4950	B
RP-T5-3FT-4L-8XX-10V-M-G2-45W	4	45	4950	B
RP-T5-4FT-3L-8XX-10V-M-G2-45W	3	45	4950	B
RP-T5-4FT-4L-8XX-10V-M-G2-45W	4	45	4950	B
RP-T5HO-4FT-2L-8XX-10V-M-G2-45W	2	45	4950	B
RP-T8-3FT-4L-8XX-10V-M-G2-45W	4	45	4950	B
RP-T8-4FT-2L-8XX-10V-M-G2-45W	2	45	4950	B
RP-T8-4FT-3L-8XX-10V-M-G2-45W	3	45	4950	B
RP-T8-4FT-4L-8XX-10V-M-G2-45W	4	45	4950	B
RP-T5-4FT-3L-8XX-10V-M-G2-50W	3	50	5500	B
RP-T5-4FT-4L-8XX-10V-M-G2-50W	4	50	5500	B
RP-T5HO-4FT-2L-8XX-10V-M-G2-50W	2	50	5500	B
RP-T8-4FT-2L-8XX-10V-M-G2-50W	2	50	5500	B
RP-T8-4FT-3L-8XX-10V-M-G2-50W	3	50	5500	B
RP-T8-4FT-4L-8XX-10V-M-G2-50W	4	50	5500	B
RP-T5-4FT-3L-8XX-10V-M-G2-60W	3	60	6600	B
RP-T5-4FT-4L-8XX-10V-M-G2-60W	4	60	6600	B
RP-T8-4FT-3L-8XX-10V-M-G2-60W	3	60	6600	B
RP-T8-4FT-4L-8XX-10V-M-G2-60W	4	60	6600	B
RP-T5-4FT-3L-8XX-10V-M-G2-70W	3	70	7700	C
RP-T5-4FT-4L-8XX-10V-M-G2-70W	4	70	7700	C
RP-T8-4FT-3L-8XX-10V-M-G2-70W	3	70	7700	C
RP-T8-4FT-4L-8XX-10V-M-G2-70W	4	70	7700	C
RP-T5-4FT-4L-8XX-10V-M-G2-80W	4	80	8800	C
RP-T5HO-4FT-3L-8XX-10V-M-G2-80W	3	80	8800	C
RP-T8-4FT-3L-8XX-10V-M-G2-80W	3	80	8800	C
RP-T8-4FT-4L-8XX-10V-M-G2-80W	4	80	8800	C





DA DRIVER* (PG. 9) W/ EMG CONFIGURATIONS (PG. 8)

PART #	LAMPS PER DRIVER	SYSTEM WATTAGE	SYSTEM LUMENS	EMG CONFIGURATION
RP-T5-2FT-1L-8XX-DA-C-G2	1	13	1430	CONFIGURATION A
RP-T5-2FT-2L-8XX-DA-C-G2	2	25	2750	CONFIGURATION A
RP-T5-2FT-3L-8XX-DA-C-G2	3	38	4180	CONFIGURATION A
RP-T5-3FT-1L-8XX-DA-C-G2	1	13	1430	CONFIGURATION A
RP-T5-3FT-2L-8XX-DA-C-G2	2	25	2750	CONFIGURATION A
RP-T5-3FT-3L-8XX-DA-C-G2	3	38	4180	CONFIGURATION A
RP-T5-4FT-1L-8XX-DA-C-G2	1	19	2090	CONFIGURATION A
RP-T5-4FT-2L-8XX-DA-C-G2	2	37	4070	CONFIGURATION A
RP-T5-4FT-3L-8XX-DA-C-G2	3	55	6050	CONFIGURATION B
RP-T5HO-2FT-1L-8XX-DA-C-G2	1	15	1650	CONFIGURATION A
RP-T5HO-2FT-2L-8XX-DA-C-G2	2	29	3190	CONFIGURATION A
RP-T5HO-2FT-3L-8XX-DA-C-G2	3	44	4840	CONFIGURATION B
RP-T5HO-3FT-1L-8XX-DA-C-G2	1	15	1650	CONFIGURATION A
RP-T5HO-3FT-2L-8XX-DA-C-G2	2	29	3190	CONFIGURATION A
RP-T5HO-3FT-3L-8XX-DA-C-G2	3	44	4840	CONFIGURATION B
RP-T5HO-4FT-1L-8XX-DA-C-G2	1	29	3190	CONFIGURATION A
RP-T5HO-4FT-2L-8XX-DA-C-G2	2	58	6380	CONFIGURATION B
RP-T5HO-4FT-3L-8XX-DA-C-G2	3	87	9570	CONFIGURATION C
RP-T5HO-4FT-3L-8XX-LVD-KN-G2	3	69	7590	CONFIGURATION C
RP-T8LO-4FT-1L-8XX-DA-C-G2	1	17	1870	CONFIGURATION A
RP-T8LO-4FT-2L-8XX-DA-C-G2	2	29	3190	CONFIGURATION A
RP-T8LO-4FT-3L-8XX-DA-C-G2	3	41	4510	CONFIGURATION B
RP-T8LO-4FT-4L-8XX-DA-C-G2	4	56	6160	CONFIGURATION B
RP-T8-2FT-1L-8XX-DA-C-G2	1	12	1320	CONFIGURATION A
RP-T8-2FT-2L-8XX-DA-C-G2	2	18	1980	CONFIGURATION A
RP-T8-2FT-3L-8XX-DA-C-G2	3	28	3080	CONFIGURATION A
RP-T8-2FT-4L-8XX-DA-C-G2	4	38	4180	CONFIGURATION B
RP-T8-3FT-1L-8XX-DA-C-G2	1	12	1320	CONFIGURATION A
RP-T8-3FT-2L-8XX-DA-C-G2	2	18	1980	CONFIGURATION A
RP-T8-3FT-3L-8XX-DA-C-G2	3	28	3080	CONFIGURATION B
RP-T8-3FT-4L-8XX-DA-C-G2	4	38	4180	CONFIGURATION B
RP-T8-4FT-1L-8XX-DA-C-G2	1	18	1980	CONFIGURATION A
RP-T8-4FT-2L-8XX-DA-C-G2	2	35	3850	CONFIGURATION A
RP-T8-4FT-3L-8XX-DA-C-G2	3	53	5830	CONFIGURATION B
RP-T8-4FT-4L-8XX-DA-C-G2	4	71	7810	CONFIGURATION B
RP-T8HO-4FT-1L-8XX-DA-C-G2	1	28	3080	CONFIGURATION A
RP-T8HO-4FT-2L-8XX-DA-C-G2	2	51	5610	CONFIGURATION B
RP-T8HO-4FT-3L-8XX-DA-C-G2	3	74	8140	CONFIGURATION C

*DEFAULT DRIVER SETTINGS: CONTROL OUTPUT ENABLED, LOGARITHMIC DIMMING, 1% DIMMING LEVEL. CONTACT US IF DIFFERENT SETTINGS ARE REQUIRED



EMG CONFIGURATIONS

4W ALL-IN-ONE EMG [CONFIGURATION A]	4W ALL-IN-ONE EMG W/ SEPARATE LIGHT ENGINE [CONFIGURATION B]	8W EMG DRIVER, SEPARATE BATTERY & LIGHT ENGINE [CONFIGURATION C]
<p>EXISTING TUBES WILL LIGHT IN EMG MODE Approximately 500 lumens for 90 minutes. Contact us for more options</p> <p>DRIVER</p>  <p>EMG DIMENSIONS: 5.34" x 1.69" x 1.01" (SEE LINE DRAWING BELOW) SEE EXAMPLE 1 BELOW FOR WIRING DIAGRAM</p>	<p>SEPARATE LIGHT ENGINE WILL LIGHT IN EMG MODE Approximately 500 lumens for 90 minutes. Contact us for more options</p> <p>DRIVER LIGHT ENGINE</p>  <p>EMG DIMENSIONS: 5.34" x 1.69" x 1.01" (SEE LINE DRAWING BELOW) LIGHT ENGINE DIMENSIONS: 4.7" x .83" x .04" SEE EXAMPLE 2 BELOW FOR WIRING DIAGRAM</p>	<p>SEPARATE LIGHT ENGINE WILL LIGHT IN EMG MODE Approximately 1000 lumens for 90 minutes. Contact us for more options</p> <p>DRIVER + LIGHT ENGINE</p>  <p>EMG DIMENSIONS: 5.34" x 1.69" x 1.01" (SEE LINE DRAWING BELOW) LIGHT ENGINE DIMENSIONS: 4.7" x .83" x .04" BATTERY DIMENSIONS: 3.48" x 2.76" x .99" (SEE LINE DRAWING BELOW)</p>

EMG

EMG W/ EXTERNAL BATTERY

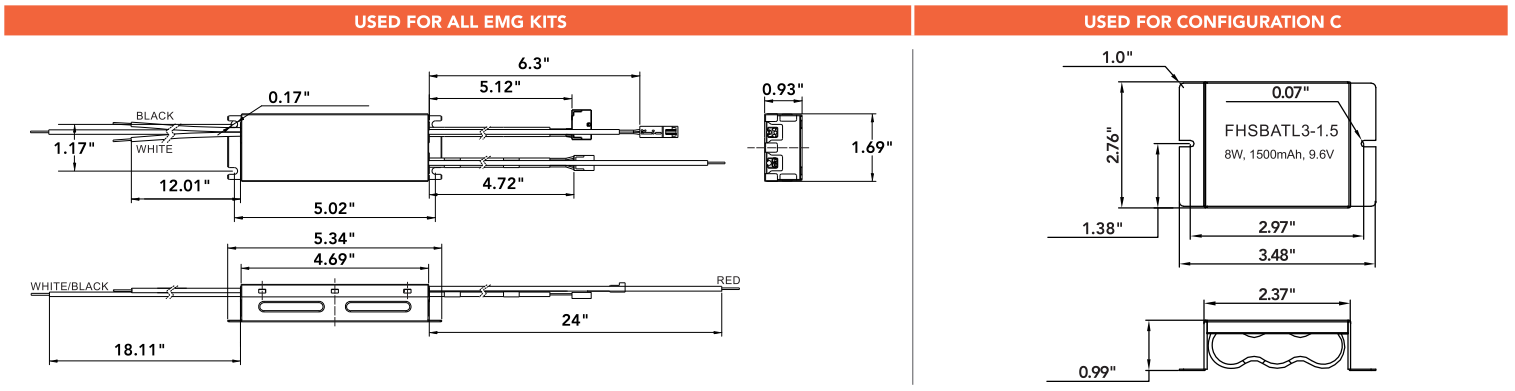

WIRING DIAGRAMS

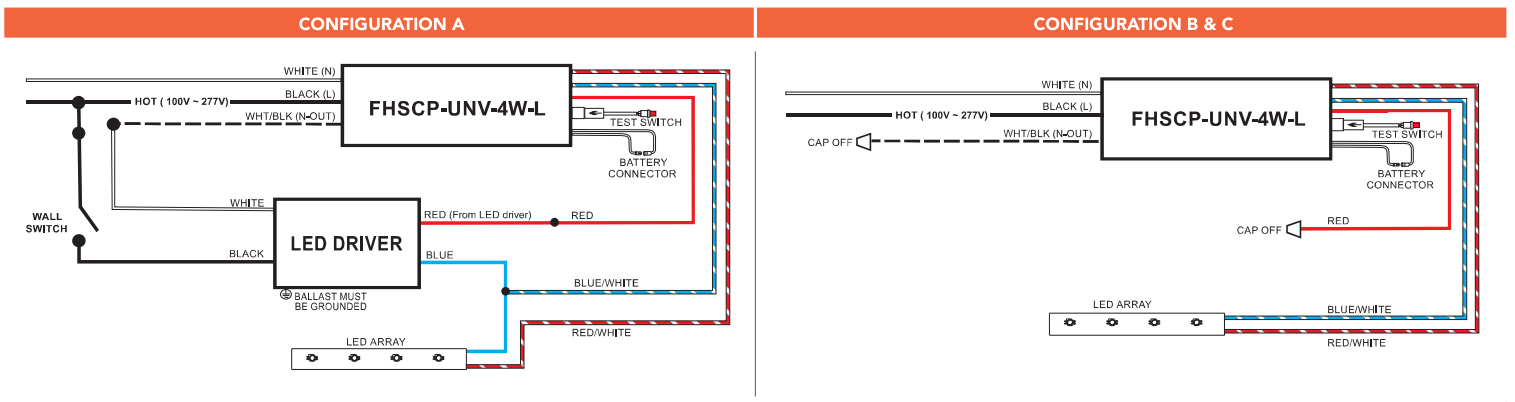



DRIVER DIMENSIONS

LUTRON



CASE TYPE K

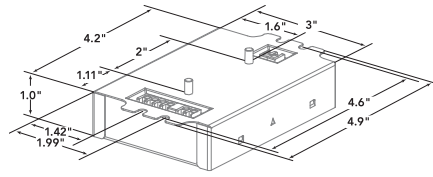

K CASE CONNECTOR LOCATIONS (WITH STUDS)

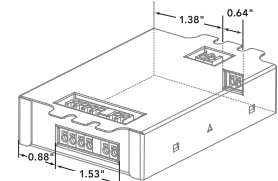

KN CASE SIDE ENTRY CONNECTOR LOCATIONS (WITHOUT STUDS)



CASE TYPE M

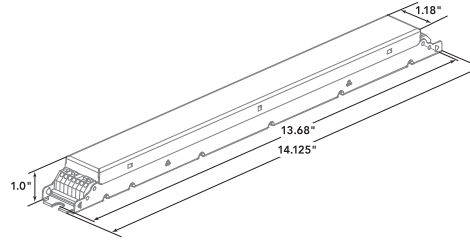

LVD



M CASE

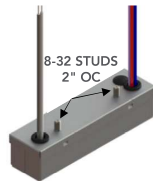

K CASE

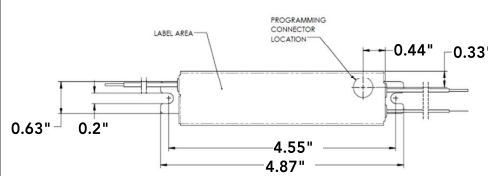

M CASE

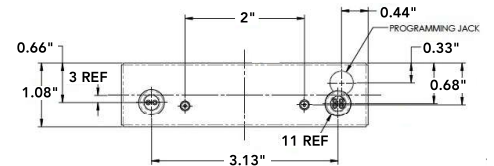

K CASE



KN CASE
25W SYSTEM MAX



KN CASE
26W-60W SYSTEM MAX

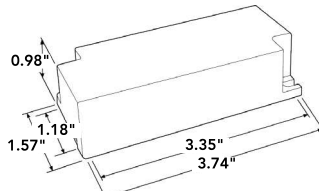

KN CASE 25W SYSTEM MAX

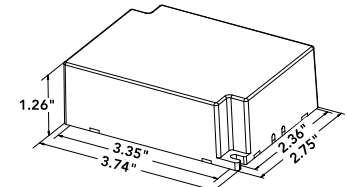

KN CASE 26W-60W SYSTEM WATTAGE

NOTE IT IS IMPORTANT THAT LVD DRIVERS ARE MOUNTED TO A FLAT SURFACE IN ORDER TO MAXIMIZE SERVICE LIFE

10V

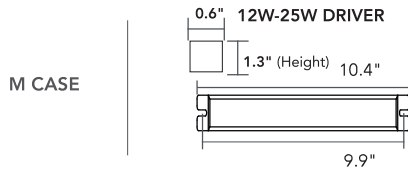

M CASE

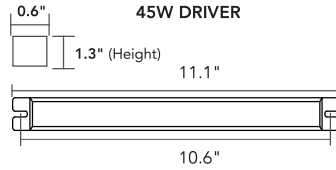

45W DRIVER

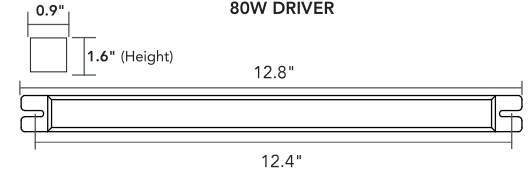

80W DRIVER

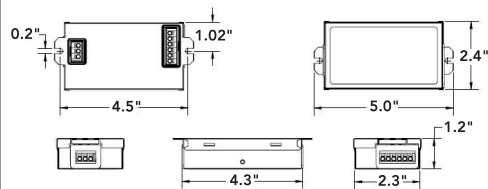

KN CASE

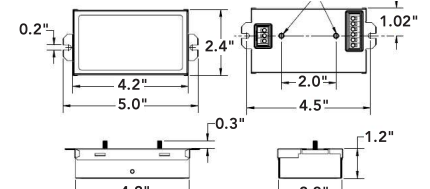

K CASE



MOST COMMON FIXTURE TYPES

CEILING / TROFFER



LINEAR STRIP



SURFACE MOUNT



FOR MORE INFORMATION VISIT C-FLEXRETROFITS.COM OR CONTACT US