

LEDCR G2 + LEDSR G2 LED RETROFIT KIT | FLEXWATT + FLEXCOLOR + FLEXCONTROL

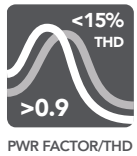

retrofitting with flexibility

5 STYLES. 4 LUMEN PACKAGES. 3 COLOR TEMPERATURES. MULTIPLE CONTROL OPTIONS.
1 PERFECT SOLUTION FOR ALL YOUR RETROFITS.

flex:COLOR

- 3000°K NEUTRAL WHITE
- 3500°K NEUTRAL WHITE
- 4000°K NEUTRAL WHITE

flex:WATT

- | | | | | |
|--------|----|-----|-----|-----|
| LED CR | 6W | 10W | 16W | 22W |
| LED SR | 6W | 9W | 12W | 15W |

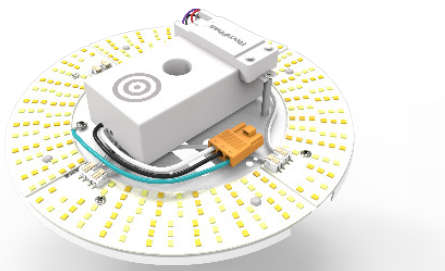

LEDCR-G2-9IN

flex:CONTROL

ADJUSTS LIGHT LEVEL FOR OCCUPANCY AND DAYLIGHT



EASY TO CHANGE SETTINGS WITH REMOTE CONTROL (OPTIONAL)

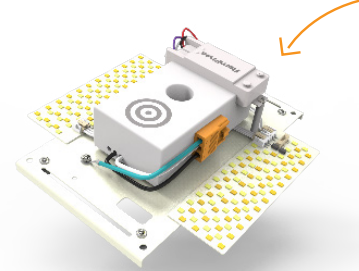

LED SR-G2-4IN

ALL STYLES SHOWN ON PAGE 4

12 RETROFIT KITS IN 1 WITH FLEXWATT™ & FLEXCOLOR™ TECHNOLOGY

- Eliminate ordering and stocking multiple wattages and color temperatures. Product offers 12 SKUs in 1 unit which can easily be configured to 4 different wattage packages and 3 different CCTs.
- Product ships at a default color temp (K) and wattage setting (install as is, or tailor the settings to fit your needs at your facility or on the job site)
- Save on labor costs by having us factory pre-set the wattage and color temperature to fit your project needs.

UL 1598C LISTED RETROFIT KIT

- Can in-field retrofit existing fixtures or be used as a light engine by OEMs to build your own fixtures.

FUTURE PROOF YOUR LIGHTING

- User replaceable and upgradeable light engine.

SUITABLE FOR DRY & DAMP LOCATIONS



FLEXCONTROL™ TECHNOLOGY

- Order control ready or basic control (integrated high/low and daylight sensor) or wireless advanced control.
- Vandal Resistant Sensors are completely adjustable and hidden behind the fixture lens.
- Adjustable via remote for sensitivity, duration of time at high light level before dimming to low, duration of time at low light level before dimming to off (factory default is to disable), daylight hold-off, and the dimmed light level.

ADAPTABLE MOUNTING

- Integrated rare-earth magnets for easy placement.
- Cut-out in center of driver allows for threaded rods.
- Flexible wiring options accommodates various wiring configurations.
- Multiple holes for self-tapping screws.

10 YEAR WARRANTY, L70 >100,000HRS

OPTIONAL EMERGENCY BATTERY BACKUP



LIGHT EFFICIENT DESIGN HEADQUARTERS 188 S. Northwest Highway • Cary, IL 60013
INNOVATION & MANUFACTURING CENTER 30 Log Bridge Road, Building 200 • Middleton, MA 01949
847.380.3540 • led-llc.com

LEDCR G2 + LEDSR G2 LED RETROFIT KIT | FLEXWATT + FLEXCOLOR + FLEXCONTROL

PART NUMBER BUILDER

MFR	FAMILY	PRODUCT	GEN	SIZE	LUMEN CODE	COLOR	FUNCTION	OPTIONS
RPT	P		G2				FWFC	

LEDCR
LEDSR

9IN	→	8L, 14L, 23L, 31L	830=3000K/85CRI
4IN	→	8L, 14L, 17L, 21L	835=3500K/85CRI
9IN	→	8L, 14L, 17L, 21L	840=4000K/85CRI
14INE	→	8L, 14L, 17L, 21L	
14INM	→	8L, 14L, 17L, 21L	

FWFC=
FlexWatt +
FlexColor

OCC=high/low motion sensor
EMG=90 min emergency battery backup
LVD=120-277V line voltage dimming

ORDERING EXAMPLE

RPT-P-LEDCR-G2-9IN-14L-830-FWFC
RPT-P-LEDSR-G2-4IN-8L-830-FWFC

Default lumen package (wattage and CCT) are shown below in bold. There are two ways to achieve a non-default lumen package and/or CCT:

1. You can easily adjust in field via our FlexWatt and FlexColor internal switches. 2. Have us adjust the FlexWatt and FlexColor at the factory for an additional charge.

ORDERING GUIDE

CASE QTY	QUICK SHIP	ENERGY STAR	REMPHOS PART #	QUICK SHIP UPC CODE	LUMEN OUTPUT (LM)	WATTAGE (W)	LPW	CCT (K)	WARRANTY (YRS)
20		●	RPT-P-LEDCR-G2-9IN-8L-830-FWFC		780	6	130	3000	10
20		●	RPT-P-LEDCR-G2-9IN-8L-835-FWFC		780	6	130	3500	10
20		●	RPT-P-LEDCR-G2-9IN-8L-840-FWFC		816	6	136	4000	10
20		●	RPT-P-LEDCR-G2-9IN-14L-830-FWFC		1370	10	137	3000	10
20		●	RPT-P-LEDCR-G2-9IN-14L-835-FWFC		1440	10	144	3500	10
20	●	●	RPT-P-LEDCR-G2-9IN-14L-840-FWFC	844006010676	1370	10	137	4000	10
20	●	●	RPT-P-LEDCR-G2-9IN-14L-840-FWFC-OCC	844006010683	1370	10	137	4000	10
20		●	RPT-P-LEDCR-G2-9IN-23L-830-FWFC		2256	16	141	3000	10
20		●	RPT-P-LEDCR-G2-9IN-23L-835-FWFC		2240	16	140	3500	10
20		●	RPT-P-LEDCR-G2-9IN-23L-840-FWFC		2352	16	147	4000	10
20		●	RPT-P-LEDCR-G2-9IN-31L-830-FWFC		2970	22	135	3000	10
20		●	RPT-P-LEDCR-G2-9IN-31L-835-FWFC		3080	22	140	3500	10
20		●	RPT-P-LEDCR-G2-9IN-31L-840-FWFC		3124	22	142	4000	10
20		●	RPT-P-LEDSR-G2-XIN-8L-830-FWFC		780	6	130	3000	10
20		●	RPT-P-LEDSR-G2-XIN-8L-835-FWFC		780	6	130	3500	10
20	●	●	RPT-P-LEDSR-G2-4IN-8L-840-FWFC	844006010690	816	6	136	4000	10
20	●	●	RPT-P-LEDSR-G2-4IN-8L-840-FWFC-OCC	844006010706	816	6	136	4000	10
20	●	●	RPT-P-LEDSR-G2-9IN-8L-840-FWFC	844006010713	816	6	136	4000	10
20	●	●	RPT-P-LEDSR-G2-9IN-8L-840-FWFC-OCC	844006010720	816	6	136	4000	10
20	●	●	RPT-P-LEDSR-G2-14INE-8L-840-FWFC	844006010737	816	6	136	4000	10
20	●	●	RPT-P-LEDSR-G2-14INE-8L-840-FWFC-OCC	844006010744	816	6	136	4000	10
20	●	●	RPT-P-LEDSR-G2-14INM-8L-840-FWFC	844006010751	816	6	136	4000	10
20	●	●	RPT-P-LEDSR-G2-14INM-8L-840-FWFC-OCC	844006010768	816	6	136	4000	10
20		●	RPT-P-LEDSR-G2-XIN-14L-830-FWFC		1370	10	137	3000	10
20		●	RPT-P-LEDSR-G2-XIN-14L-835-FWFC		1440	10	144	3500	10
20		●	RPT-P-LEDSR-G2-XIN-14L-840-FWFC		1370	10	137	4000	10
20		●	RPT-P-LEDSR-G2-XIN-17L-830-FWFC		1692	12	141	3000	10
20		●	RPT-P-LEDSR-G2-XIN-17L-835-FWFC		1680	12	140	3500	10
20		●	RPT-P-LEDSR-G2-XIN-17L-840-FWFC		1764	12	147	4000	10
20		●	RPT-P-LEDSR-G2-XIN-21L-830-FWFC		2025	15	135	3000	10
20		●	RPT-P-LEDSR-G2-XIN-21L-835-FWFC		2100	15	140	3500	10
20		●	RPT-P-LEDSR-G2-XIN-21L-840-FWFC		2130	15	142	4000	10

X = 4IN, 9IN, 14INE, or 14INM



LIGHT EFFICIENT DESIGN HEADQUARTERS 188 S. Northwest Highway • Cary, IL 60013
INNOVATION & MANUFACTURING CENTER 30 Log Bridge Road, Building 200 • Middleton, MA 01949
847.380.3540 • led-llc.com

03.23.22 Information is subject to change without notice.

LED CR G2 + LED SR G2 LED RETROFIT KIT | FLEXWATT + FLEXCOLOR + FLEXCONTROL



HOW DOES IT WORK?

Our exclusive LED driver is designed to operate at 90%+ efficiency at each wattage setting. Standard drivers would have much lower efficiency as low as 60% and would result in poor performance and reduced efficacy.

WHAT ARE THE WATTAGE CHOICES?

Please reference this table and the ordering guide on the last page of the cut sheet.

FLEXWATT TURN DIAL POSITION				
STYLE	0	1	2	3
LED CR	6W (8L)	10W (14L)	16W (23L)	22W (31L)
LED SR	6W (8L)	10W (14L)	12W (17L)	15W (21L)

HOW EASY IS IT TO SET?

Simply slide off the driver door, adjust the 4-position turn dial with a small, flat-head screw driver, and replace the door. Quick and easy. Can be "locked-out" to prevent field-adjustability if desired.

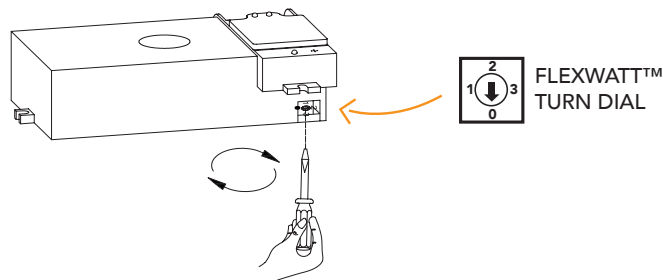

HOW DOES IT WORK?

We select the highest efficacy, multiple color LED diodes from quality suppliers, and mount them on the same circuit board. A proprietary LED binning process ensures color consistency between fixtures. The FlexColor technology controller ensures the correct color is selected, every time.

WHAT ARE THE COLOR CHOICES?

3000k, 3500k and 4000k. Please reference this table and the ordering guide on the last page of the cut sheet.

FLEXCOLOR SLIDE SWITCH POSITION		
TOP	MIDDLE	BOTTOM
3000K	3500K	4000K

HOW EASY IS IT TO SET?

Adjust the 3-position slide switch with your finger. Quick and easy. Can be "locked-out" to prevent field-adjustability if desired.

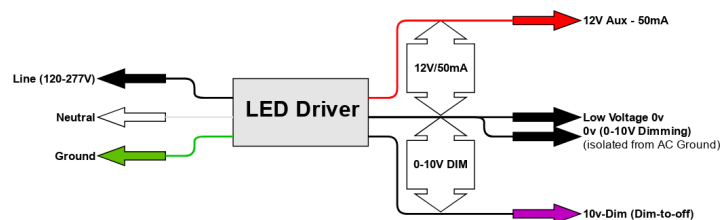
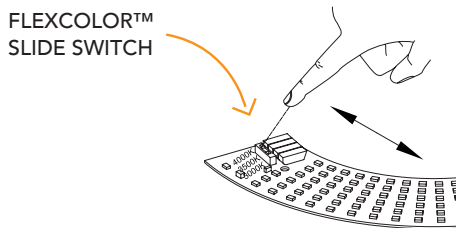

LIGHT EFFICIENT DESIGN HEADQUARTERS 188 S. Northwest Highway • Cary, IL 60013
 INNOVATION & MANUFACTURING CENTER 30 Log Bridge Road, Building 200 • Middleton, MA 01949
 847.380.3540 • led-llc.com

LEDCR G2 + LEDSR G2 LED RETROFIT KIT | FLEXWATT + FLEXCOLOR + FLEXCONTROL

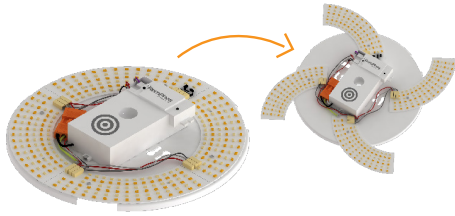

LEDCR-G2-9IN (EXPANDABLE LED BOARDS)

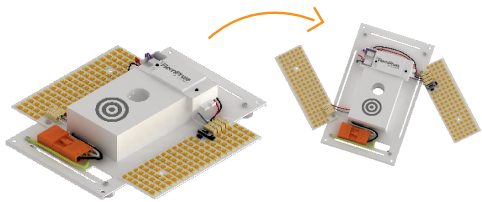
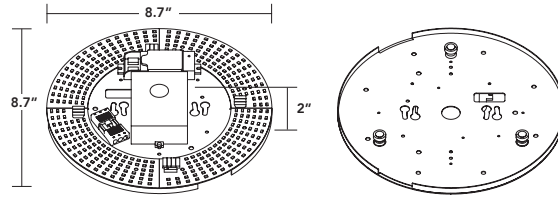

LEDSR-G2-4IN (EXPANDABLE LED BOARDS)

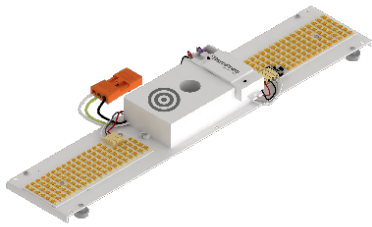
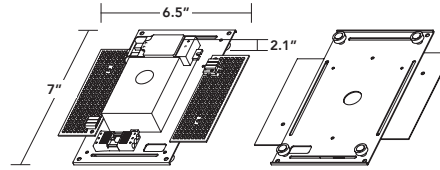

LEDSR-G2-14INM (FIXED LED BOARDS)

driver located in middle

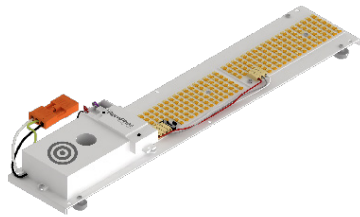
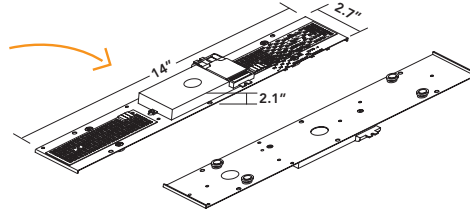

LEDSR-G2-14INE (FIXED LED BOARDS)

driver located at end

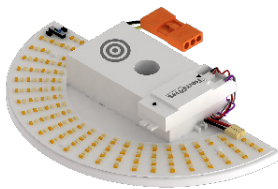
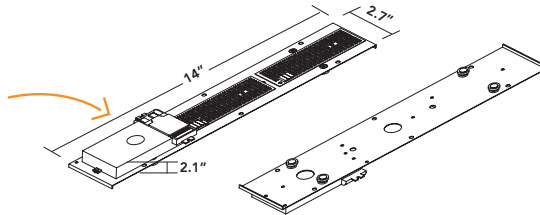

LEDSR-G2-9IN (FIXED LED BOARDS)

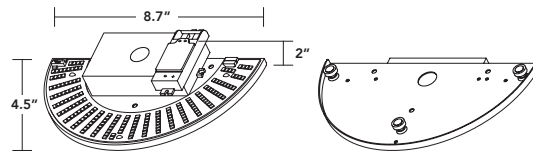

RETROFIT THESE FIXTURES & MORE



SURFACE MOUNTS



VANITIES/LINEARS



WALL MOUNTS



LIGHT EFFICIENT DESIGN HEADQUARTERS 188 S. Northwest Highway • Cary, IL 60013
 INNOVATION & MANUFACTURING CENTER 30 Log Bridge Road, Building 200 • Middleton, MA 01949
 847.380.3540 • led-llc.com

LED CR G2 + LED SR G2 LED RETROFIT KIT | FLEXWATT + FLEXCOLOR + FLEXCONTROL



CUT-OUT IN CENTER OF DRIVER ALLOWS FOR THREADED RODS

INCOMING POWER QUICK DISCONNECT LOCATED ON TOP OF CHASSIS FOR EASY AND SAFE WIRING. CLIP HOLDS DISCONNECT AND WIRING NEATLY IN PLACE.

MULTIPLE CHASSIS CUT-OUTS FOR FLEXIBLE WIRING OPTIONS

OPTIONAL INTEGRATED HIGH/LOW MOTION AND DAY-LIGHT SENSOR. COMPLETELY ADJUSTABLE AND HIDDEN BEHIND THE FIXTURE LENS

5VA DRIVER HOUSING. MEETS UL1598C REGULATIONS

CURVED LED BOARDS CAN EXPAND TO FIT SMALL TO LARGE FIXTURES

KEYHOLE SLOTS AND MULTIPLE HOLES FOR FLEXIBLE MOUNTING OPTIONS

STRONG RARE EARTH MAGNETS FOR EASY INSTALLATION

CONTROL OPTIONS

CONTROL READY

DRIVER

10V DIM

12V POWER

All LEDCR/SR models come standard as factory enabled to add controls at the factory, in the field or at a later date. Driver comes with 10V dimming and 12V DC power wiring.

BASIC CONTROL

OCC SENSOR

Integrated high frequency, high/low motion and daylight sensor. Can be mounted behind glass or plastic lens. Purchase optional remote control to adjust settings.

ORDERING CODES
SENSOR = OCC / RC = HNSIII REMOTE

ADVANCED WIRELESS CONTROL

MAGNUM
Proudly Made In America

avi-on
Smart Building Control

PHILIPS LUTRON

We partner with Magnum, avi-on, Philips, Lutron and other intelligent wireless lighting control systems. Allows for occupancy sensing, daylight harvesting, grouping, scheduling, high-end trim and more. Adjust settings via iPhone/Android apps. Contact us for

CONTACT US FOR ORDERING CODES

EASILY RETROFIT THESE FIXTURE STYLES, AND MORE!

LED CR-G2-9IN/SURFACE MOUNT

LED CR-G2-9IN/SURFACE MOUNT

LED SR-G2-9IN/SCONCE

LED SR-G2-14INM/VANITY + LINEAR

LED SR-G2-14INE/VANITY + LINEAR

LED SR-G2-4IN/SCONCE



LIGHT EFFICIENT DESIGN HEADQUARTERS 188 S. Northwest Highway • Cary, IL 60013
 INNOVATION & MANUFACTURING CENTER 30 Log Bridge Road, Building 200 • Middleton, MA 01949
 847.380.3540 • led-llc.com

LEDCR G2 + LEDSR G2

LED RETROFIT KIT | FLEXWATT + FLEXCOLOR + FLEXCONTROL



SENSOR OPTIONS: OCC / OCCLR

- OCC** Standard high/low motion sensor
 - Remote IR12
- OCCLR** Limited range high/low motion sensor
 - Remote IR12

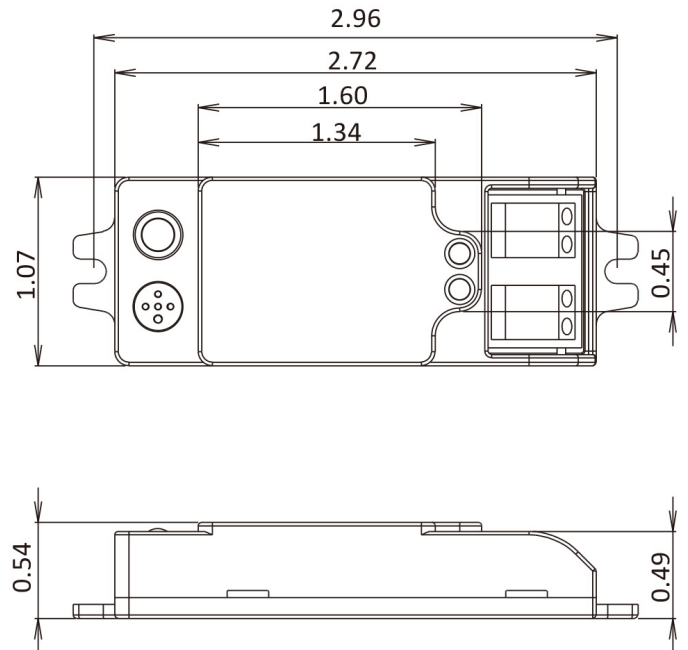
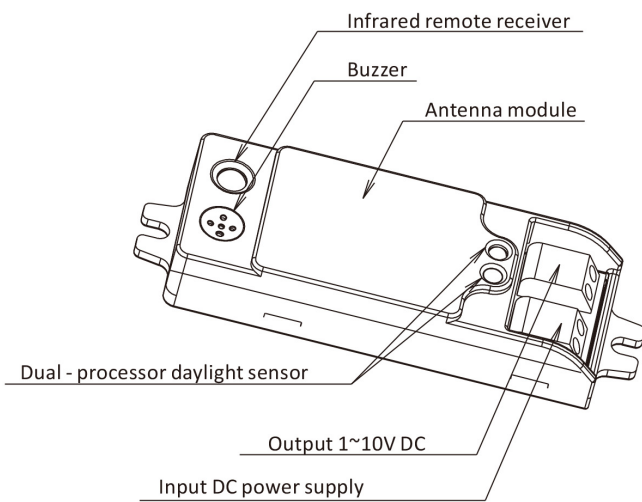

- occupancy sensor w/ daylight hold-off
- powered by 12V DC LED driver from fixture - provided by the LED poer supply
- high frequency radar occupancy sensor
- infrared remote control available (sold separately)
- uses less than 0.1W in standby mode



LIGHT EFFICIENT DESIGN HEADQUARTERS 188 S. Northwest Highway • Cary, IL 60013
INNOVATION & MANUFACTURING CENTER 30 Log Bridge Road, Building 200 • Middleton, MA 01949
847.380.3540 • led-llc.com

LED CR G2 + LED SR G2

LED RETROFIT KIT | FLEXWATT + FLEXCOLOR + FLEXCONTROL



DETECTION PATTERN OCC (STANDARD OPTION)

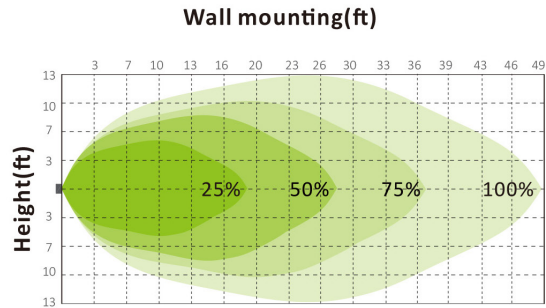
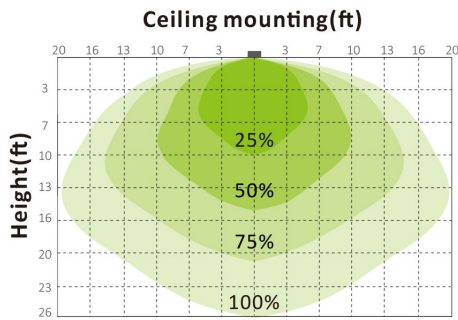

DETECTION PATTERN OCCLR (LIMITED RANGE)

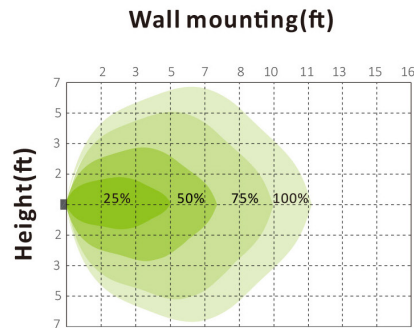
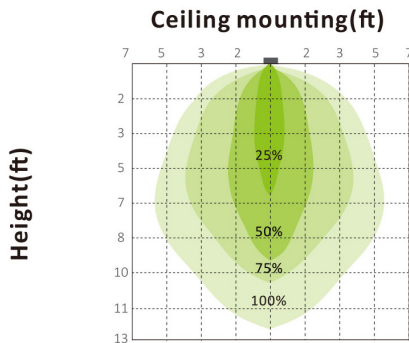

DAYLIGHT MONITORING FUNCTION

This sensor can tell the difference between natural light and artificial light (lamp) from behind the diffuser, switch on automatically (even without movements) when the ambient light is below the target value, and then switch off automatically whenever the artificial light is not required (ambient light is bright enough).

Note: Lux-Off sampling time - 30s; Lux-On sampling time - 10s

Lux-On function will only operate without motion when standby is set to + ∞.

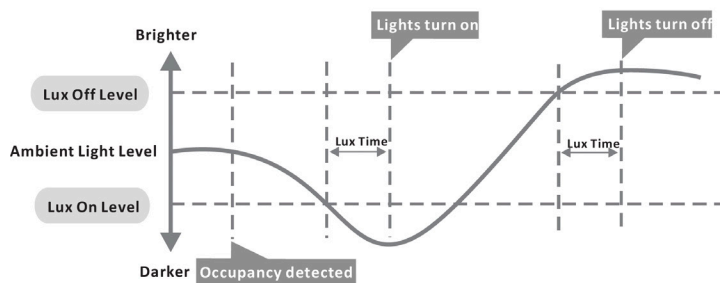

LIGHT EFFICIENT DESIGN HEADQUARTERS 188 S. Northwest Highway • Cary, IL 60013
 INNOVATION & MANUFACTURING CENTER 30 Log Bridge Road, Building 200 • Middleton, MA 01949
 847.380.3540 • led-llc.com

LED CR G2 + LED SR G2

LED RETROFIT KIT | FLEXWATT + FLEXCOLOR + FLEXCONTROL

SENSOR OPTIONS: OCC / OCCLR



Permanent ON/OFF function

Press "POWER" button, sensor is disabled.

*press "Auto", "Reset" or "Ambient learn" to quit this mode.



Dim +/-

Press "Dim" button to automatically dim up or down the light brightness during hold-time from 10% to 100%. Another press to lock it down when desired brightness is achieved.

*after desired brightness is locked down, if user wants to dim again reversely, just press the "Dim" button again and then lock down the new brightness again.



Sensor mode

Press "Auto" button, the sensor starts to work and all settings remain the same as the latest status before the sensor was disabled.



Reset function

Press "Reset" button, all settings go back to factory default settings.

* Factory default settings--

Sensitivity=100%
Daylight sensor=disable
Hold time=5min
Twilight time=+∞
Twilight level=30%



Ambient learn

Press "Ambient learn" button, the latest surrounding lux value overwrites previous lux value learned, and set as the daylight threshold. This feature enables the fixture to function well in any real application circumstance.



Test mode

"Test mode" is for testing purpose only, for users to check the functionality and choose the desired detection range. The sensor goes to test mode automatically after pressing this button.

Users can quit this mode by pressing "ON/OFF", "Reset", or any button of "Hold time". The sensor settings are changed accordingly.

* Test mode defaulted settings--

Daylight sensor=disable
Hold time=3s
Twilight time=N/A
Twilight level=N/A



IR12

Note:

- The buzzer short beeps (~0.5s) ONCE when sensor successfully receives RC signal after pressing any buttons except for "Ambient learn".
- The buzzer short beeps (~0.5s) TWICE to start learning ambient lux after pressing "Ambient learn". Then followed by a long beep (~1s) to indicate the success of ambient learning.
- When "twilight level" set at 0%, it becomes ON/OFF control.



Light Efficient Design

LIGHT EFFICIENT DESIGN HEADQUARTERS 188 S. Northwest Highway • Cary, IL 60013
INNOVATION & MANUFACTURING CENTER 30 Log Bridge Road, Building 200 • Middleton, MA 01949
847.380.3540 • led-llc.com

03.23.22 Information is subject to change without notice.

LED CR G2 + LED SR G2 LED RETROFIT KIT | FLEXWATT + FLEXCOLOR + FLEXCONTROL



SENSOR OPTIONS: OCCRF (SIMPLE GROUPING SENSOR)

- OCCRF Simple grouping high/low motion sensor
- Remote IR13

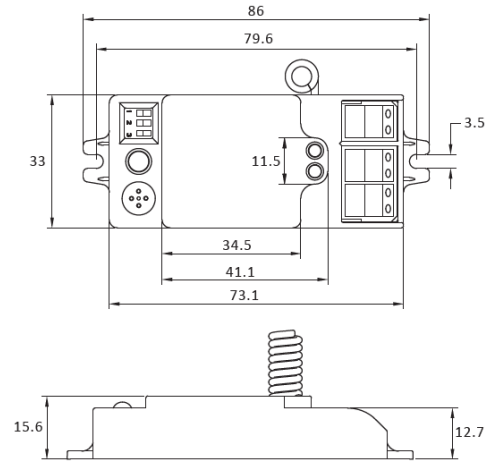
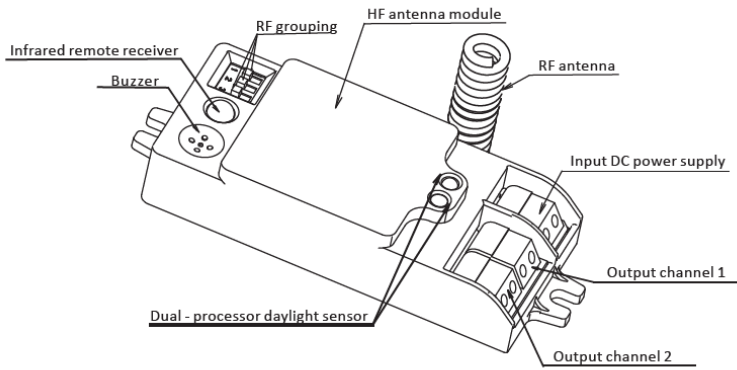

- simple grouping motion sensor w/ daylight hold-off
- powered by 12V DC - provided by the LED power supply
- max 150 ft grouping range
- ideal for stairways, parking garages and hallways
- grouping by remote or dip switch (infrared remote control sold separately)
- uses less than 0.1W in standby mode



LIGHT EFFICIENT DESIGN HEADQUARTERS 188 S. Northwest Highway • Cary, IL 60013
INNOVATION & MANUFACTURING CENTER 30 Log Bridge Road, Building 200 • Middleton, MA 01949
847.380.3540 • led-llc.com

LED CR G2 + LED SR G2 LED RETROFIT KIT | FLEXWATT + FLEXCOLOR + FLEXCONTROL

DETECTION PATTERN OCCRF

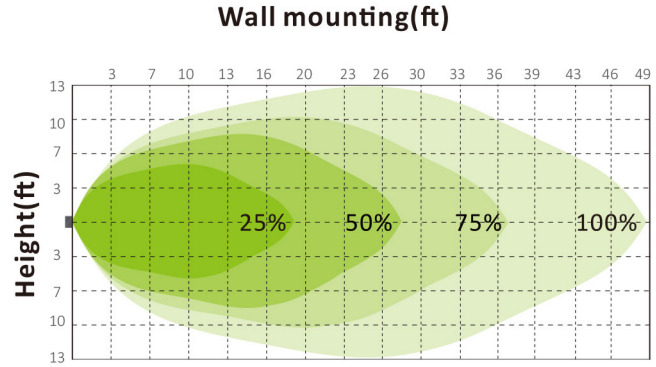
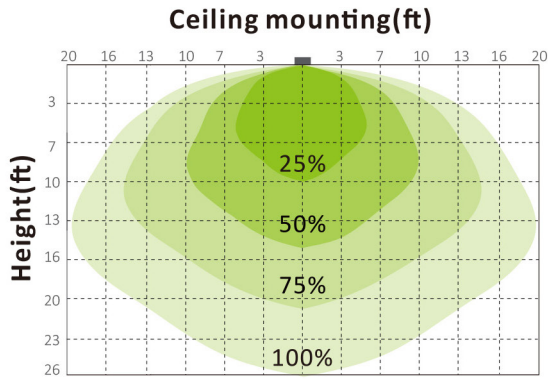

DAYLIGHT MONITORING FUNCTION

This sensor can tell the difference between natural light and artificial light (lamp) from behind the diffuser, switch on automatically (even without movements) when the ambient light is below the target value, and then switch off automatically whenever the artificial light is not required (ambient light is bright enough).

Note: Lux-Off sampling time - 30s; Lux-On sampling time - 10s

Lux-On function will only operate without motion when standby is set to + ∞.

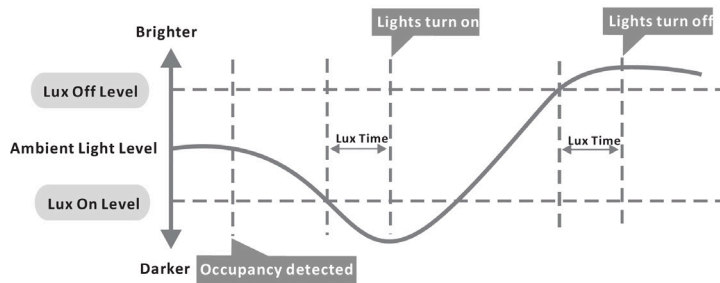

LIGHT EFFICIENT DESIGN HEADQUARTERS 188 S. Northwest Highway • Cary, IL 60013
 INNOVATION & MANUFACTURING CENTER 30 Log Bridge Road, Building 200 • Middleton, MA 01949
 847.380.3540 • led-llc.com

LED CR G2 + LED SR G2 LED RETROFIT KIT | FLEXWATT + FLEXCOLOR + FLEXCONTROL

SENSOR OPTION: OCCRF (SIMPLE GROUPING SENSOR)

OCC OFF function

Press "OCC OFF" button, the motion sensor will be disabled.

*press "OCC ON", "Reset" or "Ambient" to re-activate the motion sensor.

Dim

Press "Dim" button to automatically dim up or down the light brightness during hold-time from 10% to 100%. Another press to lock it down when desired brightness is achieved.

*After desired brightness is locked down, if user wants to dim again reversely, just press the "Dim" button again and then lock down the new brightness again.

OCC ON function

Press "OCC ON" button, the sensor starts to work and all settings remain the same as the latest status before the light was switched on / off.

Reset function

Press "Reset" button, all sensor settings go back to factory default settings.

* Factory default setting:

Sensitivity=100%
Daylight sensor=disable
Hold time=90s
Twilight time=5min
Twilight level=10%
CCT=Neutral

Ambient learn

Press "Ambient learn" button, the latest surrounding lux value overwrites previous lux value learned, and set as the daylight threshold. This feature enables the fixture to function well in any real application circumstance.

Test mode

"Test mode" is for testing purpose only, for users to check the functionality and choose the desired detection range. The sensor goes to test mode automatically after pressing this button.

Users can quit this mode by pressing "ON/OFF", "Reset", or any button of "Hold time". The sensor settings are changed accordingly.

* Test mode defaulted settings--
Daylight sensor=disable
Hold time=3s
Twilight time=N/A
Twilight level=N/A

In this mode, when used for on/off control, after motion detected, sensor enters into a cycle of 3s on and 2s off.

In this mode, when used for tri-level dimming control, after motion detected, sensor enters into a cycle of 3s on and 2s off (0.5s soft off + 1.5s off).



Note:

- The buzzer short beeps (~0.5s) ONCE when sensor successfully receives RC signal after pressing any buttons except for "Ambient learn".
- The buzzer short beeps (~0.5s) TWICE to start learning ambient lux after pressing "Ambient learn" Then followed by a long beep (~1s) to indicate the success of ambient learning.
- When "twilight level" set at 0%, it becomes ON/OFF control.
- Function zone of "CCT Adjust" is invalid for this model.



LED CR G2 + LED SR G2

LED RETROFIT KIT | FLEXWATT + FLEXCOLOR + FLEXCONTROL



SENSOR OPTION: OCCRF (SIMPLE GROUPING SENSOR)

RF Grouping (via remote control)

- Learn** Short press “Learn” button to the receiver unit to start grouping mode, the receiver unit will beep quickly (every second for 3min). This grouping mode will last for 3min, second short press on it will quit the grouping mode.
- Send** Short press “Send” button to the commander unit, it will beep once to start a 5s RF signal sending, and then beep twice to indicate finish of it. After receiving the RF signal, the receiver unit will beep 1s to indicate the success of grouping.
- Erase** Long press “Erase” button for 5s to the sensor unit, it will long beep once, to indicate the success of erasing.

Note:

- If you want the sensor to work as both commander and receiver , you need to repeat the “learn” and “send” process again with the identification exchanged.
- Each receiver can learn up to max. 32 commanders, commanders added beyond 32pcs will automatically substitute earlier ones.
- Before using the remote control for grouping, you have to position the grouping DIP switch at OFF - OFF - OFF. (default from factory)

Steps for grouping with remote control:

Step 1: Press “Learn” button on sensor A



Step 2: Press “Send” button on sensor B



Step 4: Press “Send” button on sensor A



Step 3: Press “Learn” button on sensor B

Fast RF Grouping (via DIP switch)

By simply selecting the same channel on each sensor unit, the grouping is quickly and automatically completed. Totally 7 channels are available for fast grouping.

* Channel OFF - OFF - OFF is not for fast grouping, it is for remote control grouping only.



LIGHT EFFICIENT DESIGN HEADQUARTERS 188 S. Northwest Highway • Cary, IL 60013
INNOVATION & MANUFACTURING CENTER 30 Log Bridge Road, Building 200 • Middleton, MA 01949
847.380.3540 • led-llc.com

03.23.22 Information is subject to change without notice.

SENSOR OPTION: OCCRF (SIMPLE GROUPING SENSOR)

ILLUSTRATION FOR TYPICAL PARKING GARAGE APPLICATION

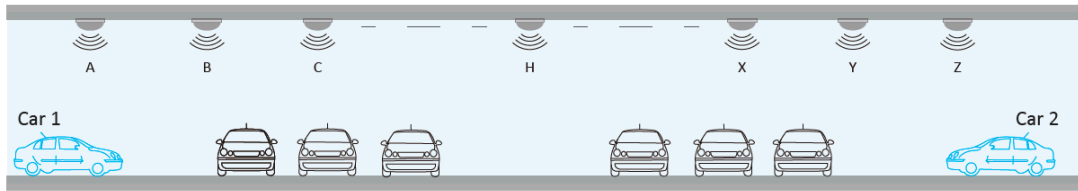

With sufficient daylight, sensor will not be triggered by motion, all lamps are off.

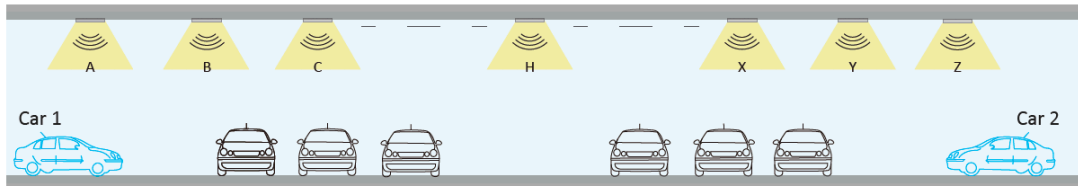

With insufficient natural light, either car 1 or car 2 enters the garage, sensor A or Z will be triggered on, and send RF signal simultaneously to all grouped sensors, all lamps will be 100% ON.

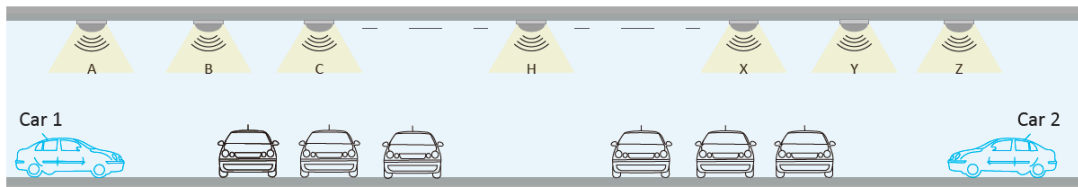

After the hold-time, the whole grouped lamps will dim to pre-defined dimming level (e.g., 10%) if no further movement detected.

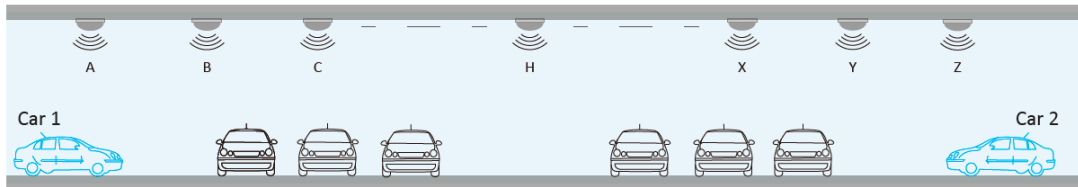

The whole grouped lamps will switch off automatically after the stand-by period if no further movement detected.

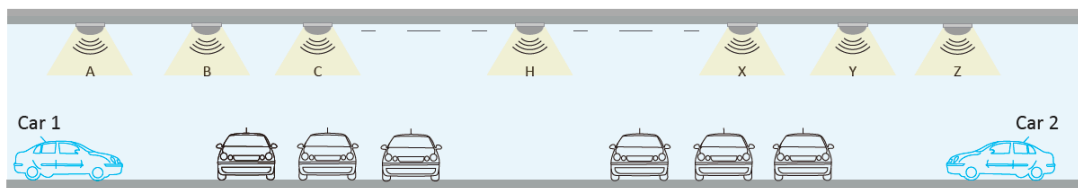

Thanks to the daylight monitoring function, even no movement detected, the sensor will automatically switch on the lamp to pre-defined stand-by dimming level (e.g., 10%), as long as the natural light is below pre-defined lux threshold. (to achieve this unique function stand-by period of the sensor has to be set at $+\infty$).

***Note:**

1. The RF transmission is a triggering signal only to activate the grouped sensors, each sensor will act based on their own settings.
2. Thanks to the Dual-processor technology, the built-in daylight sensor will shut off the lamp in real time regardless of any movements as long as the detected natural light is higher than pre-defined lux threshold.

