

SIRIUS HRI brand

High-pressure discharge lamps with reflector



Areas of application

- Concert lighting
- Club and disco
- Stage and theatre
- Studio, TV and film
- Architecture & Architainment

Product family benefits

- Lightweight and compact reflector lamps
- Perfectly suited for small and lightweight moving heads
- Optimized burner design allows any burning position
- High luminance through very short arc and high pressure
- Bright light for brilliant light effects
- Long lifetime
- Easy lamp replacement
- Stable light output over the entire lifetime



Product family datasheet

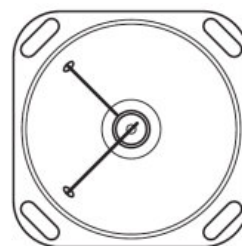
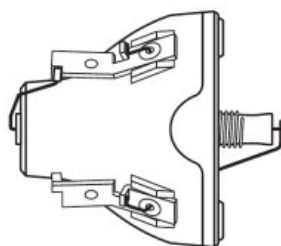
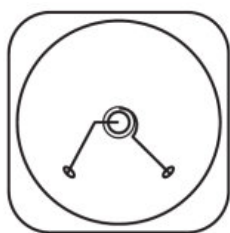
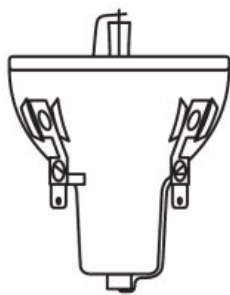

666507_SIRIUS HRI 100W

350611_SIRIUS HRI 132W

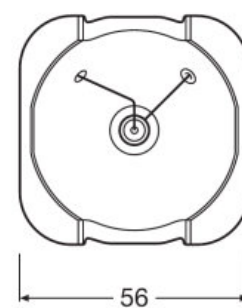
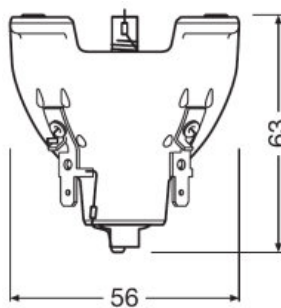
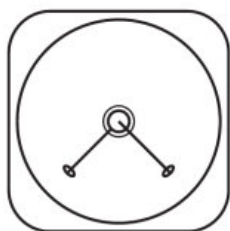
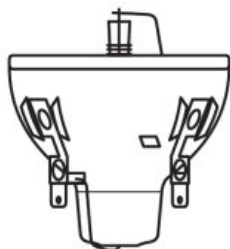

488735_SIRIUS HRI 132W

501950_SIRIUS HRI 330W

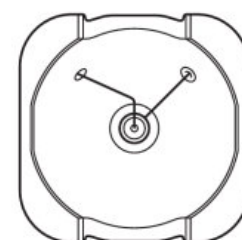
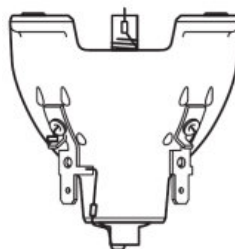
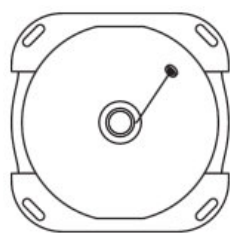
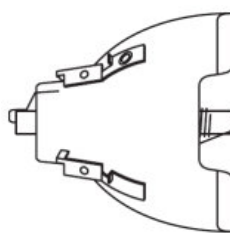

333382_SIRIUS HRI 330W

501965_SIRIUS HRI 330W

Product family datasheet

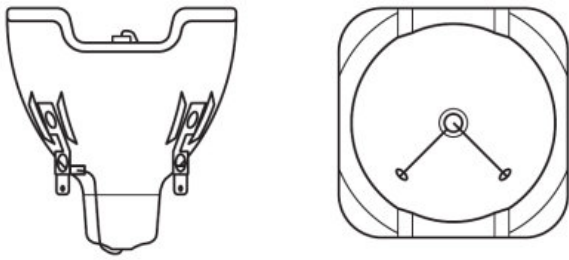

488771_SIRIUS HRI 330W X8

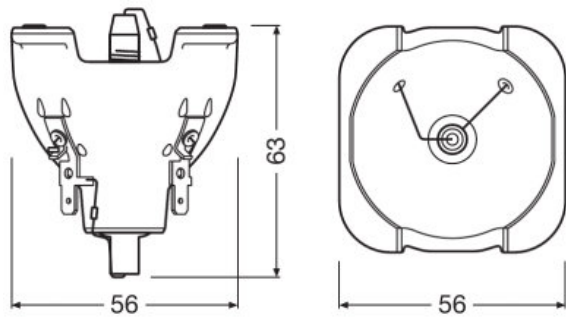

501949_Sirius HRI 330W XL

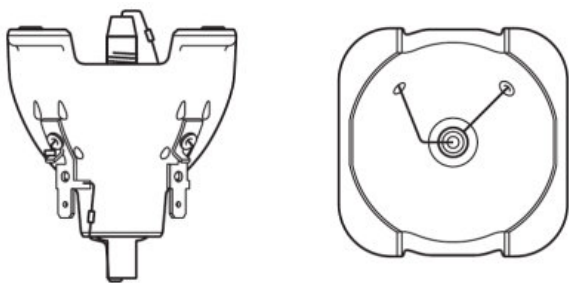

501963_Sirius HRI 330W XL

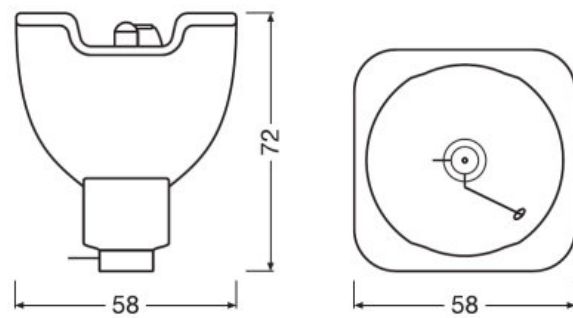

SIRIUS HRI 371W

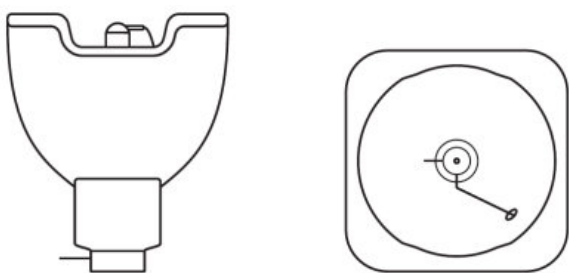

SIRIUS HRI 371W

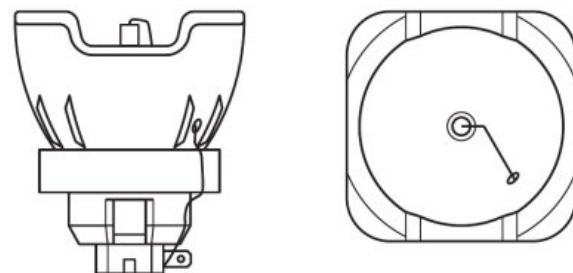

668858_SIRIUS HRI 440W

Product family datasheet

Technical data

| Product description | Electrical data | | Photometrical data | | | | Light technical data |
|---------------------|-----------------|-----------------|-----------------------|-------------------|--------------------------|---------------------------|----------------------|
| | Nominal wattage | Nominal current | Nominal luminous flux | Color temperature | Color rendering index Ra | Maximum color temperature | Focal length |
| SIRIUS HRI 100 W | 100.00 W | 1.8 A | 3680 lm | 9000 K | 60 | 9300 K | 30.0 mm |
| SIRIUS HRI 132 W SC | 132.00 W | 1.8 A | 5150 lm | 9200 K | 60 | 9200 K | 37.7 mm |
| SIRIUS HRI 140 W RO | 140.00 W | 1.9 A | 5400 lm | 9200 K | 60 | 9200 K | 37.7 mm |
| SIRIUS HRI 190 W+ | 190.00 W | 2.2 A | 8100 lm | 8200 K | 73 | 8200 K | 34.5 mm |
| SIRIUS HRI 230 W | 230.00 W | 3.3 A | 9500 lm | 8000 K | 75 | 8000 K | 34.5 mm |
| SIRIUS HRI 231 W | 231.00 W | 3.3 A | 10800 lm | 8000 K | 75 | | |
| SIRIUS HRI 280 W | 280.00 W | 4 A | 11500 lm | 7800 K | 78 | 7800 K | 35.5 mm |
| SIRIUS HRI 280 W RO | 280.00 W | 4 A | 11500 lm | 7800 K | 78 | | |
| SIRIUS HRI 281 W | 281.00 W | 4 A | 13000 lm | 7800 K | 78 | | |
| SIRIUS HRI 330 W | 330.00 W | 5 A | 12000 lm | 7400 K | 86 | 7400 K | 31.0 mm |
| SIRIUS HRI 330 W X8 | 330.00 W | 4.4 A | 18000 lm | 8000 K | 85 | | |
| SIRIUS HRI 330 W XL | 330.00 W | 5 A | 16500 lm | 7250 K | 71 | | |
| SIRIUS HRI 370W LL | 370.00 W | 5 A | 18000 lm | 7400 K | 86 | | |
| SIRIUS HRI 371 W | 371.00 W | 5 A | 18300 lm | 7650 K | 85 | | |
| SIRIUS HRI 371 W S | 371.00 W | 5 A | 19800 lm | 7650 K | 85 | | |
| SIRIUS HRI 440 W | 440.00 W | 5.3 A | 20000 lm | 7000 K | 80 | 7000 K | 41.0 mm |
| SIRIUS HRI 440 W H | 440.00 W | 5.3 A | 18000 lm | 7000 K | 75 | | |
| SIRIUS HRI 440 W S | 440.00 W | 4.4 A | 22800 lm | 7000 K | 80 | | |
| SIRIUS HRI 440 W X | 440.00 W | 5.3 A | 22800 lm | 7000 K | 80 | | |
| SIRIUS HRI 461 W | 461.00 W | 5.3 A | 24000 lm | 7500 K | 80 | | |
| SIRIUS HRI 461 W S | 461.00 W | 5.3 A | 24000 lm | 7500 K | 80 | | |
| SIRIUS HRI 470 W S | 470.00 W | 5.3 A | 21500 lm | 7000 K | 80 | | |
| SIRIUS HRI 470 W RO | 470.00 W | 5.3 A | 19500 lm | 7500 K | 80 | | |
| SIRIUS HRI 471 W SN | 471.00 W | 5.3 A | 20000 lm | 7500 K | 80 | | |
| SIRIUS HRI 550 W | 550.00 W | 6.1 A | 28000 lm | 7000 K | 75 | | |

| Product description | Aperture window, maximum | Dimensions & weight | | Lifespan | Capabilities | |
|---------------------|--------------------------|---------------------|------------|----------|------------------|---------|
| | | Diameter | Length | Lifespan | Burning position | Cooling |
| SIRIUS HRI 100 W | 5x3.8 mm | 45.0 mm | 53.0 mm | 6000 h | Any | Forced |
| SIRIUS HRI 132 W SC | 5x3.8 mm | 46.0 mm | max. 44 mm | 6000 h | Any | Forced |
| SIRIUS HRI 140 W RO | 5x3.8 mm | 46.0 mm | max. 44 mm | 6000 h | Any | Forced |
| SIRIUS HRI 190 W+ | 5x3.8 mm | 51.0 mm | 54.2 mm | 3000 h | Any | Forced |
| SIRIUS HRI 230 W | 5x3.8 mm | 51.0 mm | 54.5 mm | 2500 h | Any | Forced |
| SIRIUS HRI 231 W | | 51.0 mm | 50.0 mm | 2000 h | Any | |
| SIRIUS HRI 280 W | 5x3.8 mm | 51.0 mm | 54.5 mm | 2000 h | Any | Forced |
| SIRIUS HRI 280 W RO | | 51.0 mm | 54.5 mm | 2000 h | Any | |
| SIRIUS HRI 281 W | | 51.0 mm | 50.0 mm | 2000 h | Any | |
| SIRIUS HRI 330 W | 8.0 mm | 56.0 mm | 63.0 mm | 1500 h | Any | Forced |

Product family datasheet

| Product description | Aperture window, maximum | Dimensions & weight | | Lifespan | Capabilities | |
|---------------------|--------------------------|---------------------|---------|----------|------------------|---------|
| | | Diameter | Length | Lifespan | Burning position | Cooling |
| SIRIUS HRI 330 W X8 | | 58.0 mm | 66.0 mm | 1500 h | Any | |
| SIRIUS HRI 330 W XL | | 56.0 mm | 63.0 mm | 1500 h | Any | |
| SIRIUS HRI 370W LL | | 58.0 mm | 72.0 mm | 6000 h | Any | |
| SIRIUS HRI 371 W | | 58.0 mm | 72.0 mm | 1500 h | Any | |
| SIRIUS HRI 371 W S | | 58.0 mm | 72.0 mm | 1500 h | Any | |
| SIRIUS HRI 440 W | 8.0 mm | 58.0 mm | 71.0 mm | 1500 h | Any | Forced |
| SIRIUS HRI 440 W H | | 65.0 mm | 60.0 mm | 1500 h | Any | |
| SIRIUS HRI 440 W S | | 11.8 mm | 71.0 mm | 1500 h | Any | |
| SIRIUS HRI 440 W X | | 58.0 mm | 71.0 mm | | | |
| SIRIUS HRI 461 W | | 60.0 mm | 67.0 mm | 1500 h | Any | |
| SIRIUS HRI 461 W S | | 60.0 mm | 67.0 mm | 1500 h | Any | |
| SIRIUS HRI 470 W S | | 58.0 mm | 71.0 mm | 1500 h | Any | |
| SIRIUS HRI 470 W RO | | 60.0 mm | 67.0 mm | 1500 h | Any | |
| SIRIUS HRI 471 W SN | | 60.0 mm | 67.0 mm | 1500 h | Any | |
| SIRIUS HRI 550 W | | 60.0 mm | 67.0 mm | 1500 h | | |

| Product description | Certificates & standards |
|---------------------|--------------------------|
| | EEI – Energy Label |
| SIRIUS HRI 100 W | B |
| SIRIUS HRI 132 W SC | A |
| SIRIUS HRI 140 W RO | A |
| SIRIUS HRI 190 W+ | A |
| SIRIUS HRI 230 W | A |
| SIRIUS HRI 231 W | A |
| SIRIUS HRI 280 W | A |
| SIRIUS HRI 280 W RO | A |
| SIRIUS HRI 281 W | A |
| SIRIUS HRI 330 W | |
| SIRIUS HRI 330 W X8 | A |
| SIRIUS HRI 330 W XL | |
| SIRIUS HRI 370W LL | |
| SIRIUS HRI 371 W | |
| SIRIUS HRI 371 W S | |
| SIRIUS HRI 440 W | A |
| SIRIUS HRI 440 W H | |
| SIRIUS HRI 440 W S | A |
| SIRIUS HRI 440 W X | |
| SIRIUS HRI 461 W | |
| SIRIUS HRI 461 W S | |
| SIRIUS HRI 470 W S | |
| SIRIUS HRI 470 W RO | A |
| SIRIUS HRI 471 W SN | |
| SIRIUS HRI 550 W | |

Product family datasheet

Safety advice

Because of their high luminance, UV radiation and high internal pressure during operation, SIRIUS HRI lamps may only be operated in enclosed lamp casings specially constructed for the purpose. Appropriate filters must ensure that UV radiation is reduced to an acceptable level. Mercury is released if the lamp breaks. Special safety precautions must be taken. Information on safety and handling is available on request or can be found in the leaflet included with the lamp or in the operating instructions.

Application advice

For more detailed application information and graphics please see product datasheet.

Disclaimer

Subject to change without notice. Errors and omission excepted. Always make sure to use the most recent release.