

Project Name:	Type:
Part Number:	Date:

SELECTFIT G3 SERIES

SPECIFICATION FEATURES

- Mechanical** - SELECTFIT Downlight made from spinning aluminum, for maximizing passive cooling ensuring long life lasting LED. Post painted in matte white for standard fixture. This series is designed for remodel, direct mounting in the ceiling or for retrofitting existing commercial housings. Proprietary integrated driver for optimal heat protection and ensure long life of electronics components. Stainless steel spring action clips allow for both easy direct installation from 1/2" to 2" ceiling thicknesses and field accessibility below the ceiling for service or replacement.
- Electrical** - Field select from three lumen outputs using SelectDrive technology. The driver also features DualDim technology, for maximum adaptability in any spaces whether it's commercial, residential or mixed. Rated for 120 to 277V, 50/60 Hz the driver is both 0-10V dimmable to 5% with low-end cut off and Forward and Reverse phase dimmable at 120V down to 10%. Please consult dimmer compatibility for additional information. Sound rating <22db.
- Optical** - Self flanged spun aluminum reflector, painted with high reflection matte white. Clear aluminum or wall wash trim insert available for field installation. High resistance and non yellowing polycarbonate lenses for optimal low glare light diffusion. Featuring SelectKelvin technology with field selectable CCTs 2700/3000/3500/4000/5000K. LED binning within 3 SDCM maximum. Offered in minimum 90 CRI. 90° optical wide beam angle.
- Thermal** - Die cast heat sink maximizes passive thermal management and achieves a L70 calculated lifetime of 100,000 hours, at 25°C, meeting TM-21-19 requirements. Ambient temperature rated from -40°F to 113°F (-40°C to 45°C). IC installation for IC rated parts limited to +35°C (95.0°F) ambient temperature.
- Compliance and Warranty** - ETL Classified and Listed for wet location from the bottom under covered ceilings. Certified air-tight per ASTM 283-04. Complies with FCC 47CFR Part 15B consumer limits for EMI/RFI emissions at 120V. Suitable for use in clothes closets when installed in accordance with the NEC 410.16 spacing requirements. 4", 6" and 8" are certified IC for direct contact with insulation. 6" HO, 8" HO and 9.5" are not IC rated. Can be used for State of California Title 24 high efficacy LED compliance under JA8, 5 Year Warranty for complete fixture. Optional 10 Year Extended Warranty available, subject to same terms, conditions and installation requirements as standard 5 Year Warranty.

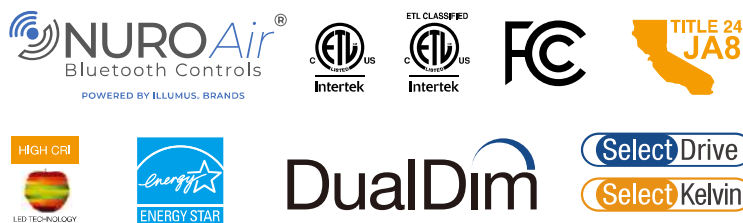

DIGITAL NAVIGATION

Explore the spec sheet through the links below

ORDERING GUIDE	NUROair CONTROLS ORDERING GUIDE
TECHNICAL INFORMATION	NOMINAL PERFORMANCE
LINE DRAWINGS	ACCESSORY ORDERING INFORMATION
PHOTOMETRY	LOGISTIC INFORMATION
CERTIFICATION INFORMATION	

BENEFITS

- DualDim technology provides the easiest remodeling, direct mount or retrofit installation dimming compatibility
- SelectKelvin technology to choose from five color temperatures ranging from 2700K to 5000K
- SelectDrive technology allow to select from 3 lumen outputs
- Install virtually anywhere with Wet Location, IC rated models and Air-tight ratings
- Factory or Field Lockable CCT and Power

SUITABLE APPLICATIONS

- Commercial
- Retail
- Hospitality
- Education
- Outdoor under covered ceilings



SELECTFIT G3 SERIES

ORDERING GUIDE

PART #		Example: SLFTG3/6/9CCT5S/DUALDIM				
Series	Size	Lumen Output	CRI	CCT	Driver	Options
SLFTG3 SELECTFIT Round Downlight	4 4" 900/750/660lm	BLANK Leave blank if you want to select the lumen output in the field	9 CRI 90+	CCT5S Selectable 2700/3000/ 3500/4000/5000K	DUALDIM 120V-277V, 50/60Hz, 0-10V or Forward /Reverse phase dimming at 120V only	BLANK None
	6 6" 1700/1300/1000lm	Factory Lumen and CCT Setting²		Factory Lumen and CCT Setting²		
	6HO 6" 2900/2320/1750lm	L Factory Set Low Output (4" - 650lm / 6" - 1000lm / 6"HO - 1750 lm / 8" 1200lm / 8" HO - 2900m / 9.5" - 2400lm)		27 Factory set 2700K		
	8 8" 2100/1600/1200lm	M Factory Set Medium Output (4" - 750m / 6" - 1300lm / 6" HO - 2320lm / 8" 1600lm / 8" HO - 3600m / 9.5" - 3200lm)		30 Factory set 3000K		
	8HO 8" 4200/3600/2900lm	H Factory Set High Output (4" - 900lm / 6" - 1700m / 6" HO - 2900m / 8" 2100 lm / 8" HO - 4200m / 9.5" - 4000lm)		35 Factory set 3500K		
9.5 9.5" 4000/3200/2400lm			40 Factory set 4000K			
				50 Factory set 5000K		NURO/RCM¹ NUROAir Ready Power Pack for Ceiling Mount Sensor. Shipped in separate box for field installation

FOOTNOTES:

- To order this option, add the NURO/RCM at the end of the Model number ex. SLFTG3/6/9CCT5S/DUALDIM/NURO/RCM. This option needs to be selected for each fixture to use with NURO7/CM.
- When factory set, the lumen and CCT should be set together. They can't be set individually.

NUROAir CONTROLS ORDERING GUIDE

Control	Switches
NURO7/CM¹ NUROAir Bluetooth Ceiling Mount Dual Mode Sensor	NURO-SW-3B-BA-BL-WP-V1 NUROAir 3-Button Bluetooth Battery Powered Wall Switch
	NURO-SW-5B-BA-BL-WP-V1 NUROAir 5-Button Bluetooth Battery Powered Wall Switch
	NURO-SW-7B-AC-BL-WP-V1 NUROAir 7-Button Bluetooth Line Voltage (AC 120-277V) Powered Wall Switch

FOOTNOTES:

- 600 sq ft sensor coverage

NUROAir by ILLUMUS

NUROAir Bluetooth Ceiling Mount Dual Mode Sensor is the optimal groupable controls lighting solution. With main features such as PIR Motion and Ultrasonic Sensing, Occupancy/Vacancy, and Bi-Level Dimming - this flexibility makes the NUROAir Bluetooth Ceiling Mount Dual Mode Sensor ideal for tailoring lighting to specific space needs, optimizing both ambiance and efficiency. The NUROAir App, available for download on iOS and Google Play Store, offers a user-friendly interface for automatic or manual customization of your space. Through the app, users can configure sensor settings such as the Light Output, CCT, Hold Time, Standby Time/Level, High/Low End Trim, Background Light Level, Set Schedules, and Control Lighting Groups or Zones, all from a mobile or tablet device. Manual control is also available with a range of compatible wireless & wired wall switch options.



[Click Here or Scan Code to Learn More About NUROAir Bluetooth Controls](#)



SELECTFIT G3 SERIES

TECHNICAL INFORMATION

Type	Dimming	Input Voltage	Input Frequency	Input Current	Input Power	THD Power	Power Factor	Flicker Index	Sound Rating
4"	0-10V and ELV/TRIAC	120-277V	50 / 60Hz	0,095A	10/8/7W	<20%	>0,9	<30%	<22db
6"				0,15A	17/13,5/10W				
6" HO				0,285A	30/24/18W				
8"				0,19A	20/16/12W				
8" HO				0,38A	42,5/37/30W				
9,5"				0,38A	40/32/24W				

NOMINAL PERFORMANCE

Product	Wattage (W)	2700K		3000K		3500K		4000K		5000K	
		Lumens (lm)	Efficacy (LPW)	Lumens (lm)	Efficacy (LPW)	Lumens (lm)	Efficacy (LPW)	Lumens (lm)	Efficacy (LPW)	Lumens (lm)	Efficacy (LPW)
SLFTG3/4	6	575	91	593	94	611	98	624	99	650	103
	7.5	674	91	696	94	720	98	735	100	766	103
	9	822	91	850	94	882	98	902	100	931	102
SLFTG3/6	10	937	108	953	110	975	112	994	114	1,012	115
	13.5	1,256	106	1,280	108	1,312	113	1,342	115	1,349	114
	17	1,687	104	1,725	107	1,775	111	1,805	113	1,796	110
SLFTG3/6HO	18	1,876	106	1,915	109	2,015	116	2,055	118	2,092	119
	24	2,456	103	2,517	106	2,669	114	2,726	116	2,761	116
	30	2,932	99	3,011	103	3,211	111	3,279	113	3,290	112
SLFTG3/8	12	1,169	107	1,191	110	1,227	115	1,243	116	1,265	116
	16	1,634	106	1,671	108	1,728	114	1,753	115	1,764	114
	20	2,004	103	2,057	107	2,155	113	2,171	112	2,153	111
SLFTG3/8HO	30	3,281	113	3,316	115	3,388	119	3,432	120	3,452	119
	37	3,962	111	4,020	113	4,121	117	4,179	118	4,186	117
	42.5	4,435	109	4,525	112	4,666	116	4,747	118	4,739	116
SLFTG3/9,5	24	2,547	111	2,587	114	2,640	117	2,657	117	2,660	115
	32	3,362	108	3,432	111	3,515	115	3,530	114	3,487	111
	40	4,141	108	4,258	112	4,380	117	4,392	115	4,315	111



SELECTFIT G3 SERIES

LINE DRAWINGS

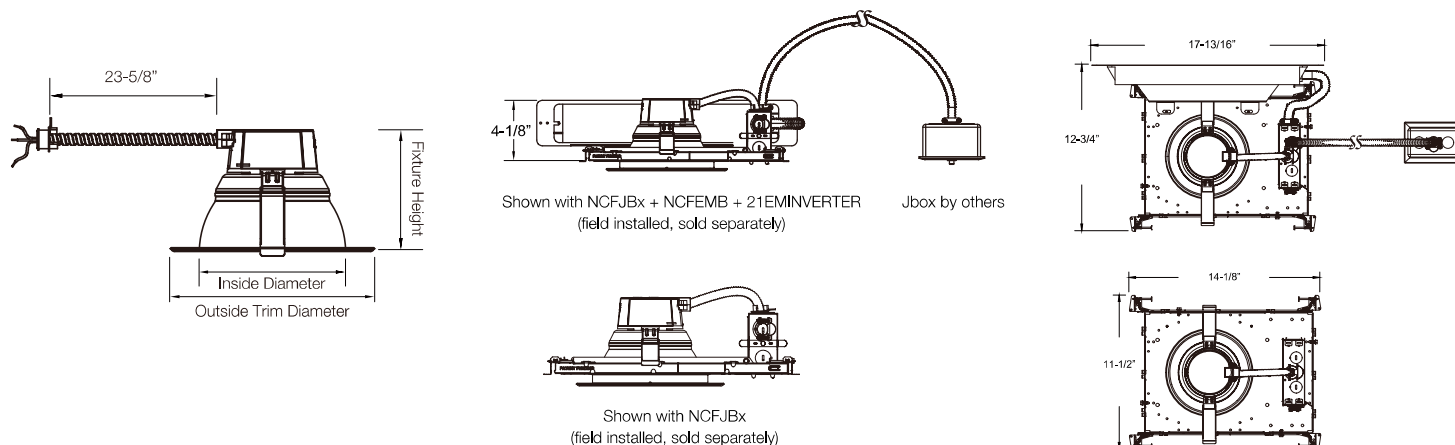

Fixture	Inside Diameter	Outside Trim Diameter	Fixture Height	Minimum Ceiling Cutout (Remodel /Retrofit/Direct Mount)	Maximum Ceiling Cutout (Remodel /Retrofit/Direct Mount)
SLFTG3/4	4-1/8"	5-15/16"	4-1/8"	4-1/8"	5-1/8"
SLFTG3/6	6-1/16"	8-1/4"	4-15/16"	6-1/8"	7-1/2"
SLFTG3/6HO	6-1/16"	8-1/4"	4-15/16"	6-1/8"	7-1/2"
SLFTG3/8	7-5/8"	10-1/4"	5-11/16"	7-11/16"	9-7/16"
SLFTG3/8HO	7-5/8"	10-1/4"	5-11/16"	7-11/16"	9-7/16"
SLFTG3/9.5	8-5/8"	11-3/8"	6-3/16"	8-11/16"	10-9/16"

ACCESSORY ORDERING INFORMATION

Product	Model	Description	Pictures	Dimensions
37041	SLFT4/CL/TRIM	SELECTFIT G2 4" Field Installable flangeless clear trim insert (Clips inside the reflector for Clear + White Flange finish)		
37042	SLFT6/CL/TRIM	SELECTFIT G2 6" Field Installable flangeless clear trim insert (Clips inside the reflector for Clear + White Flange finish)		
37043	SLFT8/CL/TRIM	SELECTFIT G2 8" Field Installable flangeless clear trim insert (Clips inside the reflector for Clear + White Flange finish)		
35157	SLFT/TRIM4/CC	4" Clear Diffuse Trim and Flange Insert (Attaches on the flange for Clear + Clear flange finish)		
35158	SLFT/TRIM6/CC	6" Clear Diffuse Trim and Flange Insert (Attaches on the flange for Clear + Clear flange finish)		

Note: All rights reserved. All sizes and specifications are subject to change at any time without notice.













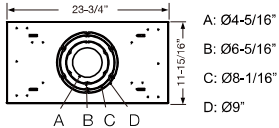

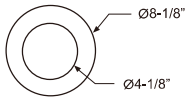

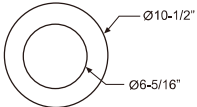
SELECTFIT G3 SERIES

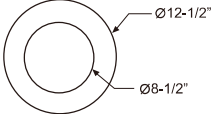
ACCESSORY ORDERING INFORMATION				
Product	Model	Description	Pictures	Dimensions
35159	SLFT/TRIM8/CC	8" Clear Diffuse Trim and Flange Insert (Attaches on the flange for Clear + Clear flange finish)		
35160	SLFT/TRIM9.5/CC	Field installable 9.5" Clear Trim and flange Insert (Attaches on the flange for clear + clear flange finish)		
37039	SLFT4/WW/ACC	SELECFIT G2 4" Field installable Wall Wash white insert (wall wash insert can not be combined with Trim insert)		
37040	SLFT6/WW/ACC	SELECFIT G2 6" Field installable Wall Wash white insert (wall wash insert can not be combined with Trim insert)		
35121	NCFJB4	4" New Construction Frame for T-Grid ceilings and stud/joist mounting		
35122	NCFJB6	6" New Construction Frame for T-Grid ceilings and stud/joist mounting		
35123	NCFJB8	8" New Construction Frame for T-Grid ceilings and stud/joist mounting		
35124	NCFJB9.5	9.5" New Construction Frame for T-Grid ceilings and stud/joist mounting		
35126	NCFBFB	Field Installable Butterfly Brackets For New Construction Frame		
35125	NCFEMB	Field Installable Emergency Bracket For New Construction Frame		
98280	NCDL46RPLATE	4" & 6" New Construction Plate for Stud/Joist Mounting		

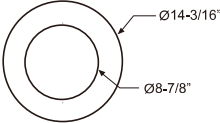
Note: All rights reserved. All sizes and specifications are subject to change at any time without notice.

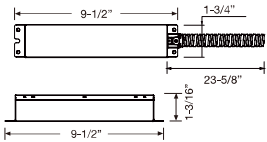

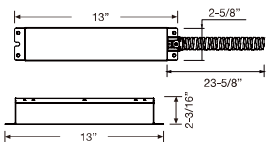
SELECTFIT G3 SERIES

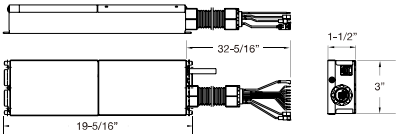
ACCESSORY ORDERING INFORMATION					
Product	Model	Description	Pictures	Dimensions	
98501	NCPLATE/T4689	New Construction or Remodel Plate for T-Grid Ceilings			
98569	GOOFRING4	4" Goof Ring - Outer Diameter 8-1/8"			
98568	GOOFRING6	6" Goof Ring - Outer Diameter 10-1/2"			
98567	GOOFRING8	8" Goof Ring - Outer Diameter 12-1/2"			
98566	GOOFRING9.5	9.5" Goof Ring - Outer Diameter 14-3/16"			
37934	8EMINVERTER	California Title 20 Compliant 8W Emergency LED Inverter (Field Installation)			
38096	24EMINVERTER	California Title 20 Compliant 24W Emergency LED Inverter (Field Installation)			
FHUPS1-UNV-25L-SD	FHUPS1-UNV-25L-SD	25W Emergency Micro Inverter for field installation to use with 0-10V Driver options, 100-277VAC (up to 150W with use of 0-10V dimming). CEC Compliant			

FOOTNOTES: For details of compatibility between each emergency solution and specific product models, please refer to the Products Emergency Compatibility Matrix file available on <https://greencreative.com/emergency-accessories/>



SELECTFIT G3 SERIES

PHOTOMETRY

SLFTG3/4/9CCT5S/DUALDIM (at 3500K)

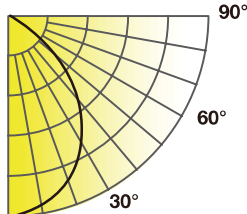

Candlepower Distribution	
Angle (°)	Average (cd)
10	426
20	390
30	328
40	252
50	170
60	187
70	42
80	14
90	0

Initial Footcandles		
Height (ft)	Fc	Diameter (ft)
8	7	16
10	4	19
12	3	23
15	2	29
20	1	39

Zonal Lumen Summary		
Zone	Lumens	%Fixt
0-30	323	37
0-40	505	57
0-60	784	89
0-90	881	100

Lumens: 882 lm
CBCP: 438 cd
Power: 9.0 W
Efficacy: 98 lm/W
CRI: 90
Spacing Criteria: 1.1
Beam Angle: 88°

SLFTG3/6/9CCT5S/DUALDIM (at 3500K)

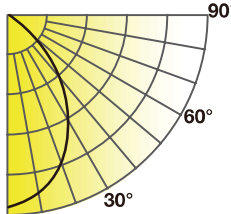

Candlepower Distribution	
Angle (°)	Average (cd)
10	927
20	849
30	713
40	520
50	306
60	148
70	74
80	30
90	0

Initial Footcandles		
Height (ft)	Fc	Diameter (ft)
8	15	14
10	10	18
12	7	22
15	4	27
20	2	36

Zonal Lumen Summary		
Zone	Lumens	%Fixt
0-30	704	40
0-40	1,090	61
0-60	1,603	90
0-90	1,773	100

Lumens: 1,775 lm
CBCP: 957 cd
Power: 17 W
Efficacy: 111 lm/W
CRI: 90
Spacing Criteria: 1.1
Beam Angle: 84°

SLFTG3/6HO/9CCT5S/DUALDIM (at 3500K)

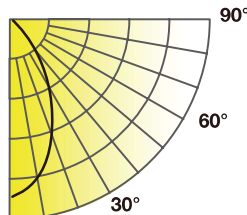

Candlepower Distribution	
Angle (°)	Average (cd)
10	1,689
20	1,545
30	1,285
40	926
50	5541
60	267
70	128
80	55
90	0

Initial Footcandles		
Height (ft)	Fc	Diameter (ft)
8	27	14
10	17	18
12	12	21
15	8	27
20	4	35

Zonal Lumen Summary		
Zone	Lumens	%Fixt
0-30	1,278	40
0-40	1,973	61
0-60	2,901	90
0-90	3,205	100

Lumens: 3,211 lm
CBCP: 1,744 cd
Power: 30 W
Efficacy: 111 lm/W
CRI: 90
Spacing Criteria: 1.1
Beam Angle: 83°

SLFTG3/8/9CCT5S/DUALDIM (at 3500K)

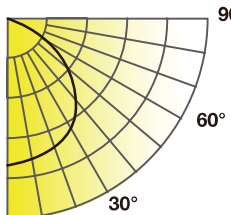

Candlepower Distribution	
Angle (°)	Average (cd)
10	1,089
20	1,001
30	859
40	646
50	395
60	179
70	80
80	38
90	0

Initial Footcandles		
Height (ft)	Fc	Diameter (ft)
8	18	15
10	11	19
12	8	23
15	5	28
20	3	38

Zonal Lumen Summary		
Zone	Lumens	%Fixt
0-30	832	39
0-40	1,304	61
0-60	1,954	91
0-90	2,151	100

Lumens: 2,155 lm
CBCP: 1,120 cd
Power: 20 W
Efficacy: 113 lm/W
CRI: 90
Spacing Criteria: 1.2
Beam Angle: 87°

SLFTG3/8HO/9CCT5S/DUALDIM (at 3500K)

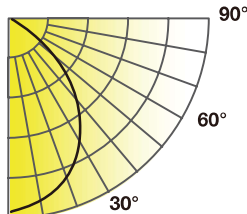

Candlepower Distribution	
Angle (°)	Average (cd)
10	2,260
20	2,090
30	1,812
40	1,388
50	882
60	423
70	185
80	88
90	0

Initial Footcandles		
Height (ft)	Fc	Diameter (ft)
8	18	15
10	11	19
12	8	23
15	5	28
20	3	38

Zonal Lumen Summary		
Zone	Lumens	%Fixt
0-30	1,740	37
0-40	2,745	59
0-60	4,194	90
0-90	4,657	100

Lumens: 4,666 lm
CBCP: 2,319 cd
Power: 42.5 W
Efficacy: 116 lm/W
CRI: 90
Spacing Criteria: 1.2
Beam Angle: 89°

SLFTG3/9.5/9CCT5S/DUALDIM (at 3500K)

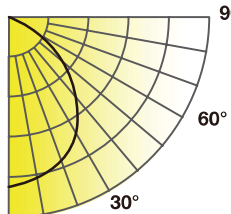

Candlepower Distribution	
Angle (°)	Average (cd)
10	2,042
20	1,915
30	1,665
40	1,307
50	849
60	405
70	195
80	94
90	0

Initial Footcandles		
Height (ft)	Fc	Diameter (ft)
8	18	15
10	11	19
12	8	23
15	5	28
20	3	38

Zonal Lumen Summary		
Zone	Lumens	%Fixt
0-30	1,587	36
0-40	2,520	58
0-60	3,902	89
0-90	4,372	100

Lumens: 4,380 lm
CBCP: 2,085 cd
Power: 40 W
Efficacy: 117 lm/W
CRI: 90
Spacing Criteria: 1.2
Beam Angle: 92°



SELECTFIT G3 SERIES

LOGISTIC INFORMATION

Product	Model	Shipping Carton		
		Case Qty	Case Dimensions (LxWxH)	Case Weight
38633	SLFTG3/4/9CCT5S/DUALDIM	6pcs	13-1/16" x 6-5/8" x 15-3/16"	10,8 lb
38634	SLFTG3/6/9CCT5S/DUALDIM	6pcs	17-7/8" x 9-1/16" x 17-1/16"	12,35 lb
38635	SLFTG3/6HO/9CCT5S/DUALDIM	6pcs	17-7/8" x 9-1/16" x 17-1/16"	13,01 lb
38636	SLFTG3/8/9CCT5S/DUALDIM	6pcs	21-13/16" x 11" x 20-13/16"	14,99 lb
38637	SLFTG3/8HO/9CCT5S/DUALDIM	6pcs	21-13/16" x 11" x 20-13/16"	15,87 lb
38638	SLFTG3/9.5/9CCT5S/DUALDIM	6pcs	24" x 12-3/16" x 21-3/4"	19,46 lb

CERTIFICATION INFORMATION

Product	Model	ES ID#
38633	SLFTG3/4/9CCT5S/DUALDIM	4439619
38634	SLFTG3/6/9CCT5S/DUALDIM	4439620
38636	SLFTG3/8/9CCT5S/DUALDIM	4439621
38635	SLFTG3/6HO/9CCT5S/DUALDIM	4439614
38637	SLFTG3/8HO/9CCT5S/DUALDIM	4439615
38638	SLFTG3/9.5/9CCT5S/DUALDIM	4439617