



# VR44-MU-xxx-8yy-xxxxA

## 44" UNIVERSAL INPUT LINEAR LED RETROFIT KITS

- Suitable for 2' x 4' luminaires
- Suitable for use in retrofit rebate programs
- Kitted for ease of installation with provided harness
- Universal Voltage with 0-10V dimming
- Optional lens to diffuse light
- L70= >60,000hrs / L90= >40,000hrs
- High performance efficacy up to 156lm/W
- cULus Classified
- Class 2 Lighting System
- Applications: Airports, Offices, Schools, Residential Buildings, Stadiums, etc.

### General Specifications

Input Voltage <sup>①</sup>	120-277V (+/- 10%)
Input Current <sup>①</sup>	Please see page #2 for specific setup
Input Power <sup>①</sup>	Please see page #2 for specific setup
Input PF	>0.9
THD	<20%
Dimming Type/Range	0-10V /100% ~ 10%
Beam Angle	120°
CRI	80CRI
Storage Temperature Range	-40°C to 100°C / -40°F to 212°F
Operating Temperature Range (Ta)	-40°C to 58°C / -40°F to 136.4°F
Maximum Driver Case Temperature (Tc)	T1M1UNV105P-40E Max: 88°C / 190.4°F T1M1UNV240P-96L Max: 85°C / 185°F T1M1UNV0700-30L Max: 86°C / 186.8°F T1M1UNV1400-60L Max: 84°C / 183.2°F T1M1UNV2100-88L Max: 90°C / 194°F
Maximum Module Case Temperature	L70: Tc max 105°C (Ts=110°C) / L90: Tc max 105°C (Ts=110°C)
Estimated Lumen Maintenance <sup>②</sup>	L70: >60,000Hrs / L90: 40,000Hrs
Color Consistency	Binning per ANSI C78.377-2015 @ 25°C; 3 SDCM
Overall Size of Modules	44" L x 1.5" W x 0.39" H (1120mm x 38mm x 10mm)
Overall Size of Drivers	T1M1UNV105P-40E 10.83" L x 1.22" W x 0.98" H (275mm x 31mm x 25mm) T1M1UNV240P-96L 6.69" L x 2.56" W x 1.26" H (170mm x 65mm x 32mm) T1M1UNV0700-30L 4.65" L x 1.18" W x 1.16" H (118mm x 30mm x 29.5mm) T1M1UNV1400-60L 9.49" L x 1.69" W x 1.21" H (241mm x 43mm x 30.7mm) T1M1UNV2100-88L 9.49" L x 1.69" W x 1.14" H (241mm x 43mm x 29mm)
Packaging	Components individually packaged
Magnets Qty. / Magnetic Force	3 / 2N (.45lbf) per magnet
Thermal Feedback	Not Available
Safety/Compliance	Retrofit Kit: cULus (File # E486779)  DLC 4.3: Linear LED Retrofit (Standard and Premium)  Please reference DLC QPL <a href="https://www.designlights.org/search/?search=fulham">https://www.designlights.org/search/?search=fulham</a>  Suitable for UL Class 2 Lighting Systems RoHS Compliant Dry and Damp Location CE Module (IEC 62031: 2008. AMD1: 2012, AMD2: 2014) CE Drivers: T1M1UNV105P-40E T1M1UNV0700-30L T1M1UNV1400-60L T1M1UNV2100-88L  SELV ( Drivers: T1M1UNV105P-40E / T1M1UNV0700-30L / T1M1UNV1400-60L)
RFI/EMI	FCC Part 15B Consumer, EN55015
Input Surge Test	References driver specification
Sound Rating	A
Service Life	50,000hrs @ Max. Tc of module and driver
Energy Efficiency Label (EEI-Label)	A++
Warranty	5 years @ Max. Tc from the date of manufacture

<sup>①</sup> Measured electrical data per UL file

<sup>②</sup> TM-21 Reported Numbers



VR44-MU-xxx-8yy-xxxxA

Part Number Matrix

**V R 44 M U x xx 8 yy xxxx A**

Product Line	Type	Module Length	Dimming	Input Voltage	# of Modules	Max. Module Rated Power	CRI	Color Temperature	Driver Output Current	Options
V = Vizion	R = Retrofit Kit (cULus Classified)	44 = 44"	M = 0-10V	UNV = 120~277VAC	1 2 4	95 = 95W	Ⓢ8 = 80	27 = 2700K Ⓢ30 = 3000K Ⓢ35 = 3500K Ⓢ40 = 4000K Ⓢ50 = 5000K 57 = 5700K 65 = 6500K	0700 = 700mA 1050 = 1050mA 1400 = 1400mA 2100 = 2100mA 2400 = 2400mA 4200 = 4200mA	A = Standard Option

Electrical and Optical Specifications

LED Retrofit VR Number	LED Module Part Number	Number of Modules	Drive Current per Module	LED Driver Part Number	Number of Drivers	Input Voltage (V)	Input Current 120/277V (A)	Total System Power (W)	Driver Efficiency @ 277V (%)	Total System Lumens (lm)	Total System Efficacy (lm/W)	Wiring Diagram*
VR44-MU-195-840-0700A	TMU240095CL840A	1	700 mA	T1M1UNV0700-30L	1	120~277VAC	0.23/0.103	27.2	85	4480	165	1P
VR44-MU-295-840-0700A	TMU240095CL840A	2	350 mA	T1M1UNV0700-30L	1	120~277VAC	0.225/0.101	26.6	85	4460	168	2P
VR44-MU-295-840-1050A	TMU240095CL840A	2	525 mA	T1M1UNV105P-40E	1	120~277VAC	0.337/0.153	40.2	85	6756	168	2P
VR44-MU-295-840-1400A	TMU240095CL840A	2	700 mA	T1M1UNV1400-60L	1	120~277VAC	0.45/0.2	52.5	88	8960	171	2P
VR44-MU-495-840-2100A	TMU240095CL840A	4	525 mA	T1M1UNV2100-88L	1	120~277VAC	0.658/0.292	76.9	89	13512	176	4P
VR44-MU-495-840-2400A	TMU240095CL840A	4	600 mA	T1M1UNV240P-96L	1	120~277VAC	0.738/0.331	87.1	90	15404	177	4P
VR44-MU-495-840-4200A	TMU240095CL840A	4	1050 mA	T1M1UNV2100-88L	2	120~277VAC	1.359/0.603	158.7	89	26420	167	2P (x2)

Luminous Flux De-Rating: CCT and CRI Multipliers

	2700K	3000K	3500K	4000K	5000K	5700K	6500K
CRI 80(R9> 0)	0.92	0.95	0.97	1.00	1.01	1.01	1.00
CRI 90(R9>50)	0.77	0.84	0.83	0.85	0.86	0.86	0.85

NOTES:

- Performance based on Tc mod = 25°C. See thermal de-rating chart (pg. 3) for higher temperature operation
- Standard lumen output and efficacy is calculated for standard options. Reference CCT & CRI vs Luminous Flux chart for lumen ratio calculation.
- Specifications are subject to change without notice.
- The LED DC Module can be configure with different LED chip quantities, series and parallel design configurations to meet a specific design requirement. Contact Fulham for further assistance.
- 70CRI is NOT available
- Driver Efficiency @277V

\* See page #8 for Wiring Diagram

Ⓢ Standard Product offering (All other options are made to order with MOQ and lead time)



# VR44-MU-xxx-8yy-xxxxA

## Thermal Specifications

### LinearHO Retrofi Kit

Storage Temperature Range	-40 to 100°C / -40 to 212°F
Operating Temperature Range (Ta)	-40 to 55°C / -40 to 131°F
Maximum Driver Case Temperature (Tc)	T1M1UNV105P-40E Max: 88°C / 190.4°F
	T1M1UNV240P-96L Max: 85°C / 185°F
	T1M1UNV0700-30L Max: 86°C / 186.8°F
	T1M1UNV1400-60L Max: 84°C / 183.2°F
	T1M1UNV2100-88L Max: 90°C / 194°F
Maximum Module Case Temperature	L70: Tc max 105°C (Ts=110°C) / L90: Tc max 105°C (Ts=110°C)



## Thermal De-Rating: Tc vs. Forward Voltage vs. Luminous Flux

Module Case Temperature (Tc)	Total Vf Multiplier	Luminous Flux Multiplier
25°C	1.000	1.000
30°C	1.000	0.991
35°C	0.997	0.982
40°C	0.993	0.973
45°C	0.993	0.964
50°C	0.990	0.953
55°C	0.987	0.944
60°C	0.987	0.935
65°C	0.984	0.926
70°C	0.984	0.917
75°C	0.980	0.908
80°C	0.977	0.899
85°C	0.977	0.889
90°C	0.974	0.880
95°C	0.970	0.862
100°C	0.967	0.853



# VR44-MU-xxx-8yy-xxxxA



## Certification Chart

Classification	Model
RoHS COMPLIANT	VR44-MU-xxx-8yy-xxxxA
cRUUS	YES
DLC QPL LISTED PREMIUM	VR44-MU-195-8yy-0700A VR44-MU-295-8yy-0700A VR44-MU-295-8yy-1050A VR44-MU-295-8yy-1400A VR44-MU-495-8yy-2100A VR44-MU-495-8yy-2400A VR44-MU-495-8yy-4200A
CE	Drivers: T1M1UNV105P-40E T1M1UNV0700-30L T1M1UNV1400-60L T1M1UNV2100-88L Module: TMU140055CL8xxA TMU240095CL8xxA
Energy Efficiency Label (EEI-Label)	A++
Suitable for UL Class 2 Lighting System	YES

## Energy Star™ TM-21 Calculator Data

Tc Module	Reported L70	Reported L90
55°C	>60,000 Hrs	>54,000 Hrs
85°C	>60,000 Hrs	46,000 Hrs
105°C	>60,000 Hrs	40,000 Hrs
Tc Module	Calculated L70	Calculated L90
55°C	180,000 Hrs	54,000 Hrs
85°C	154,000 Hrs	46,000 Hrs
105°C	133,000 Hrs	40,000 Hrs

## Product Image: 44" Universal Input LED Troffer Retrofit Kits

### VR44-MU-xxx-8yy-xxxxA



### TOP VIEW



(Varies per Driver model)

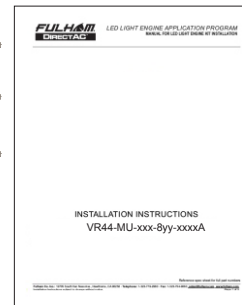

**WARNING:** Risk of fire and electrical shock. Luminaire wiring and electrical parts may be damaged when drilling for installation of LED retrofit kit. Check for enclosed wiring and components.

**Avertissement:** Risque d'incendie et d'électrocution, câblage des luminaires et pièces électriques peuvent être endommagés lors du forage pour l'installation du kit de conversion à DEL. Vérifier le câblage et les composants ci-joint.

## Hardware Kit: TLC-HW14 (x2)

LinearHO UNV Retrofit Kit includes:  
LED Module, LED Driver, Hardware, Harness, Labels & Installation Instructions

Components individually packaged

1) DLC listed with 3K and higher CCT's. For specific models please visit: <https://www.designlights.org/search/?search=fulham>

# VR44-MU-xxx-8yy-xxxxA

## Mechanical Drawings (Module)

**44"**  
[1120mm]

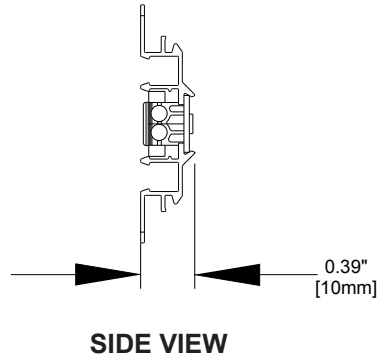

Overall Dimensions	
Length	44" [1120mm]
Width	1.73" [44mm]
Height	0.39" [10mm]

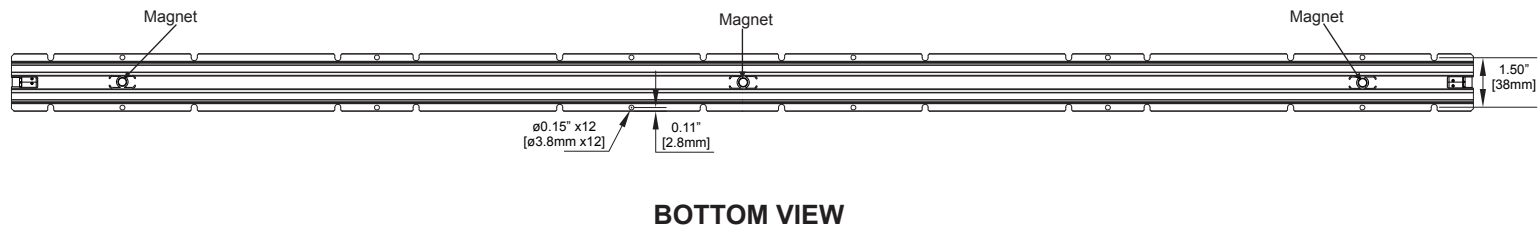
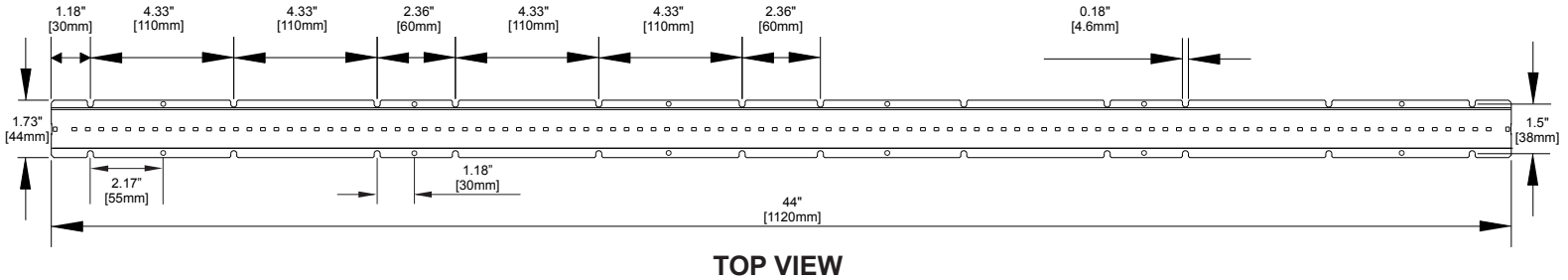

## Mechanical Drawings (Harness)

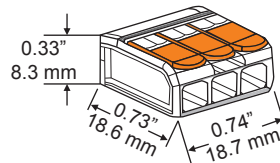
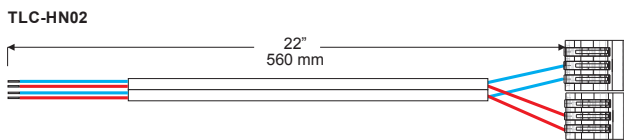

Overall Dimensions	
Length (wire)	22" [560mm]
Depth (connector)	0.73" [18.6mm]
Width (connector)	0.74" [18.7mm]
Height (connector)	0.33" [8.3mm]

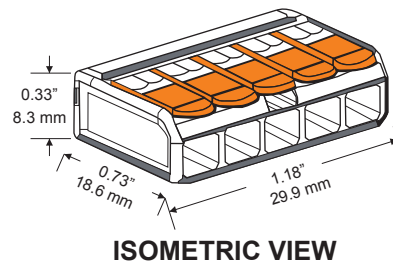
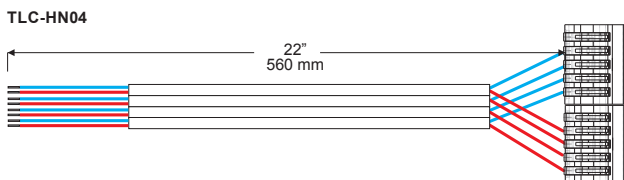

Overall Dimensions	
Length (wire)	22" [560mm]
Depth (connector)	0.73" [18.6mm]
Width (connector)	1.18" [29.9mm]
Height (connector)	0.33" [8.3mm]

# VR44-MU-xxx-8yy-xxxxA

## Mechanical Drawings (Drivers)

### T1M1UNV105P-40E

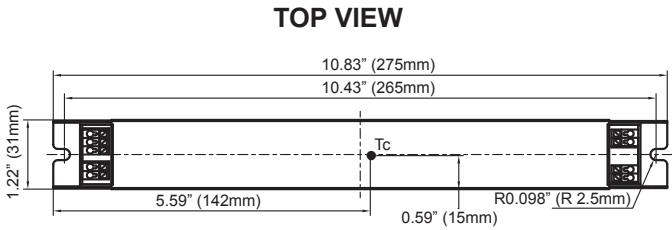

### SIDE VIEW

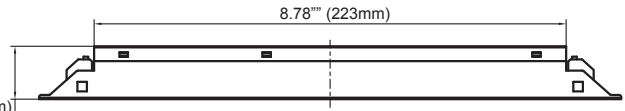

Overall Dimensions	
Length	10.83" [275mm]
Width	1.22" [31mm]
Height	0.98" [25mm]

### T1M1UNV240P-96L

### TOP VIEW

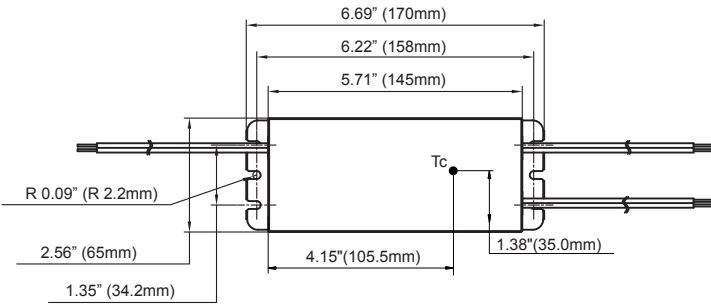

### SIDE VIEW

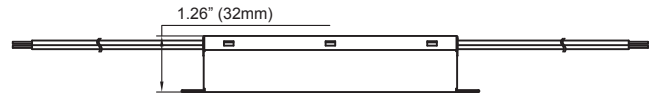

Overall Dimensions	
Length	6.69" [170mm]
Width	2.56" [65mm]
Height	1.26" [32mm]

### T1M1UNV0700-30L

### TOP VIEW

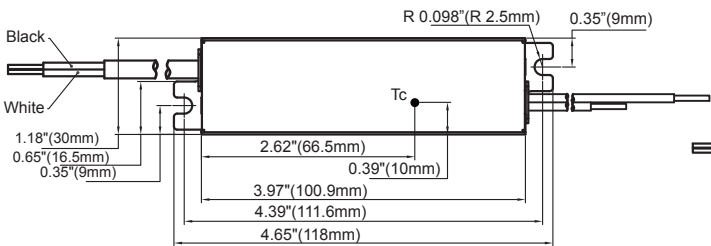

### SIDE VIEW

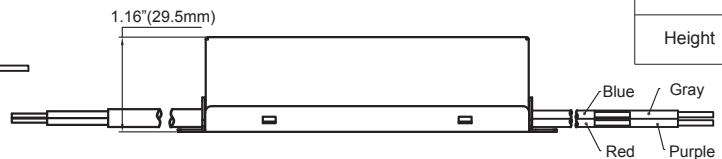

Overall Dimensions	
Length	4.65" [118mm]
Width	1.18" [30mm]
Height	1.16" [29.5mm]

# VR44-MU-xxx-8yy-xxxxA

## Mechanical Drawings (Drivers-Cont.)

### T1M1UNV1400-60L

TOP VIEW

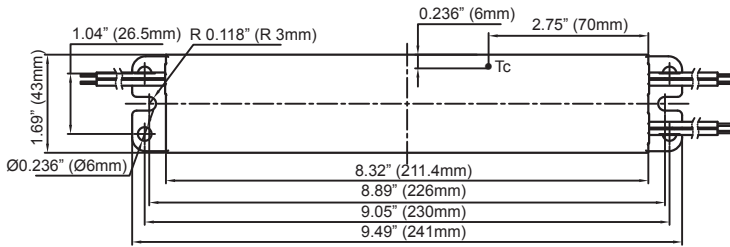

SIDE VIEW

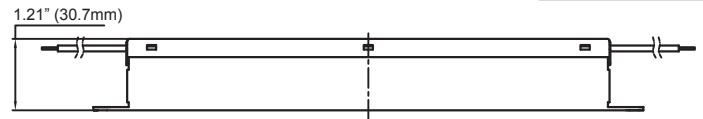

Overall Dimensions	
Length	9.49" [241mm]
Width	1.69" [43mm]
Height	1.21" [30.7mm]

### T1M1UNV2100-88L

TOP VIEW

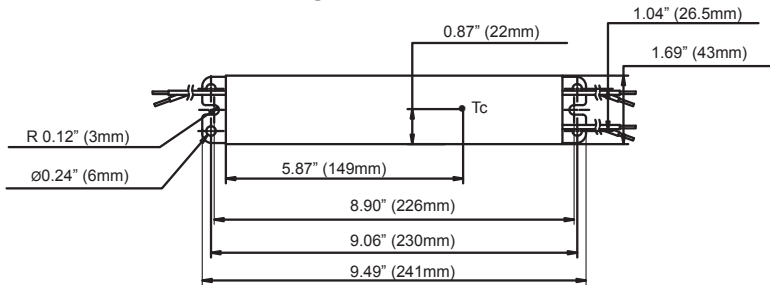

SIDE VIEW

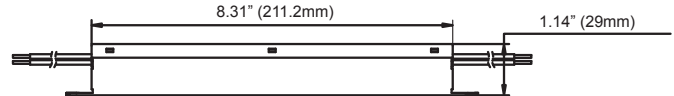

Overall Dimensions	
Length	9.49" [241mm]
Width	1.69" [43mm]
Height	1.14" [29mm]

# VR44-MU-xxx-8yy-xxxxA

## Wiring Diagram

1. Connect the driver positive wire (Red +) to the harness positive wires (Red +)
2. Connect the driver negative wire (Blue -) to the harness negative wires (Blue -)
3. Connect the harness positive wires (Red +) to the module(s) positive connector (+)
4. Connect the harness negative wires (Blue -) to the module(s) negative connector (-)

### One Module Wiring (1P)

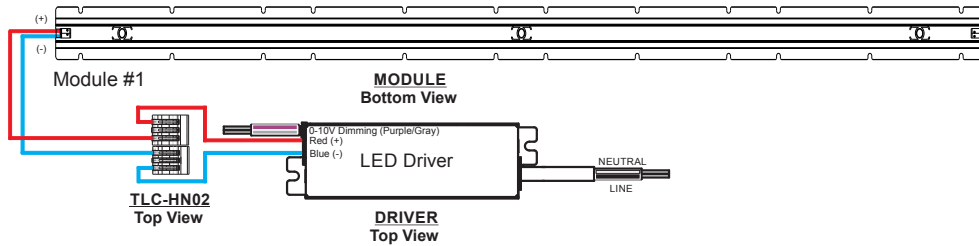

### Two Module Wiring (2P)

When using LED Retrofit VR number: VR44-MU-495-840-4200A, use 2P Wiring Diagram per LED Driver

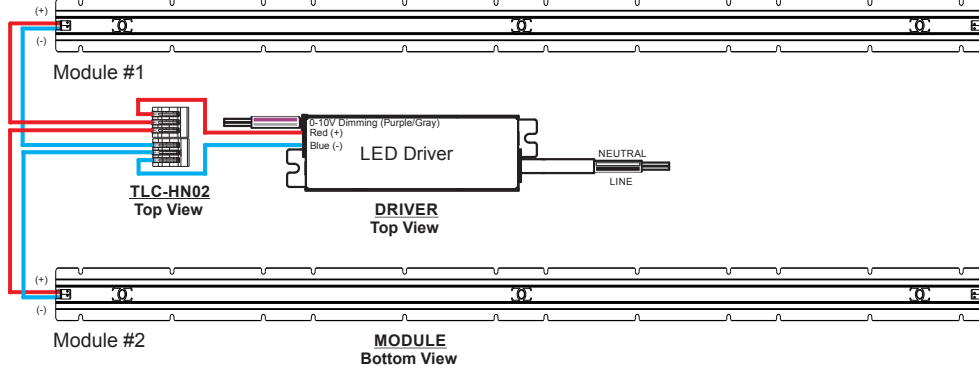

### Four Module Wiring (4P)

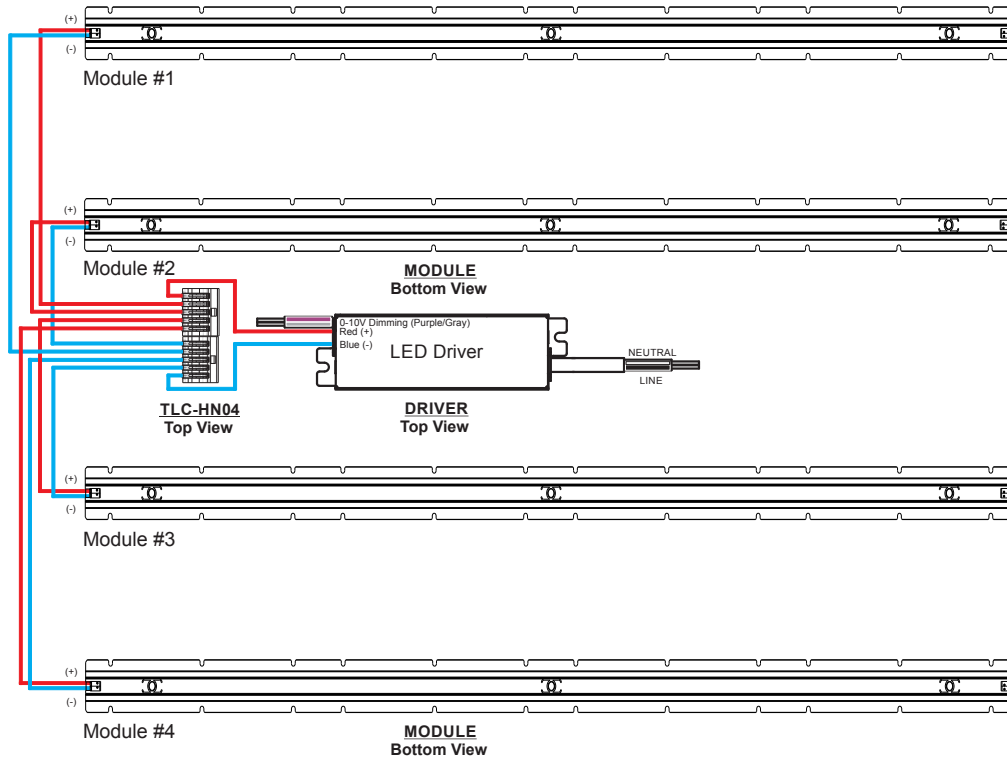

# VR44-MU-xxx-8yy-xxxxA

Accessories (Not included with kit)

## 44" Diffuser Lens

Fulham Part Number: **44": TLE-OPT-120-013**

- White polycarbonate diffuser lens - 82% transmissivity at nominally rated currents.

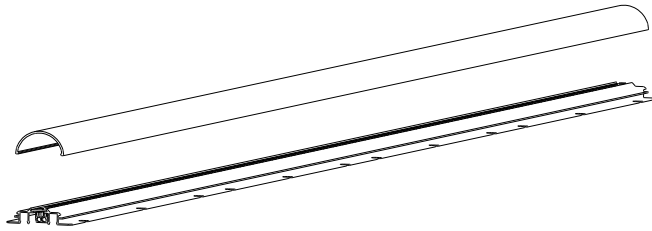

ISOMETRIC VIEW

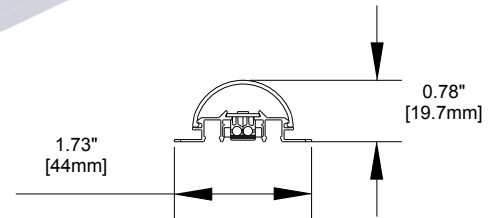

SIDE VIEW

**Installation Steps when using clamps:**

1. Place the LED Module on the luminaire surface.
2. Place the Diffuser lens on top of LED module (line it up with LED module mounting edges).
3. Push down to snap into place.

## End Caps

Fulham Part Number: **TLE-OPT-120-020**

- White Polybutylene Terephthalate (PBT) end caps

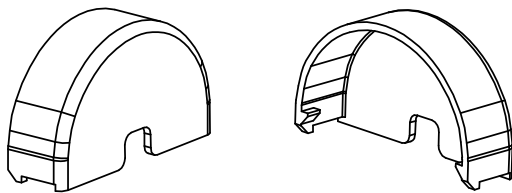

ISOMETRIC VIEW

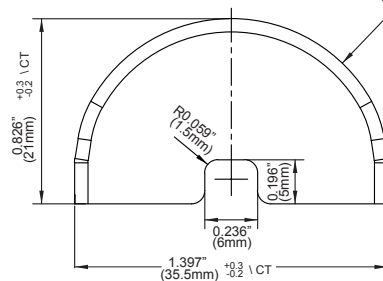

SIDE VIEW

## Interconnects

- Interconnect Type: WAGO Double pins to interconnect Modules (#2060-952)
- Approvals: cURus, UL 1977, and RoHS Compliant

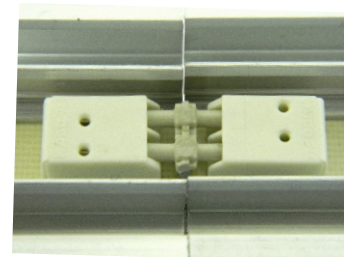

Bottom View

**NOTES:**

- 1) Interconnects are NOT sold by Fulham.
- 2) For more detail information, please visit Wago's website: <http://www.wago.com/infomaterial/pdf/60291132.pdf>

# VR44-MU-xxx-8yy-xxxxA

## Luminaire Compatibility

LED Retrofit VR Number Compatible Luminaire Type	Troffer Recessed Luminaire (1x4)	Troffer Recessed Luminaire (2x4)	Linear Highbay Luminaire (4 Lamp)	Vapor Tight Luminaire (1x4)	Vapor Tight Luminaire (2x4)	Number of LED Modules	Number of LED Drivers	Input Voltage (VDC)	Input Current (A)		Total System Power (W)	Driver Efficiency (%)	Total System Lumens (lm)	Total System Efficacy (lm/W)
									120V	277V				
VR44-MU-195-8yy-0700A	✓	✓		✓	✓	1	1	120-277	0.23	0.103	27.2	85	4480	165
VR44-MU-295-8yy-0700A	✓	✓		✓	✓	2	1	120-277	0.225	0.101	26.6	85	4460	168
VR44-MU-295-8yy-1050A	✓	✓		✓	✓	2	1	120-277	0.337	0.153	40.2	85	6756	168
VR44-MU-295-8yy-1400A	✓	✓		✓	✓	2	1	120-277	0.45	0.2	52.5	88	8960	171
VR44-MU-495-8yy-2100A		✓	✓		✓	4	1	120-277	0.658	0.292	76.9	89	13512	176
VR44-MU-495-8yy-2400A		✓			✓	4	1	120-277	0.738	0.331	87.1	90	15404	177
VR44-MU-495-8yy-4200A			✓			4	1	120-277	1.359	0.603	158.7	89	26420	167



Troffer Luminaire



Vapor Tight Luminaire



Highbay Luminaire

### NOTES:

- 1) Checkmark (✓) = cULus Classified Application
- 2) DLC listed with 3K and higher CCT's. For specific models please visit: <https://www.designlights.org/search/?search=fulham>
- 3) All electrical and lumen calculations based at 277V



# VR44-MU-xxx-8yy-xxxxA

## Color and Binning

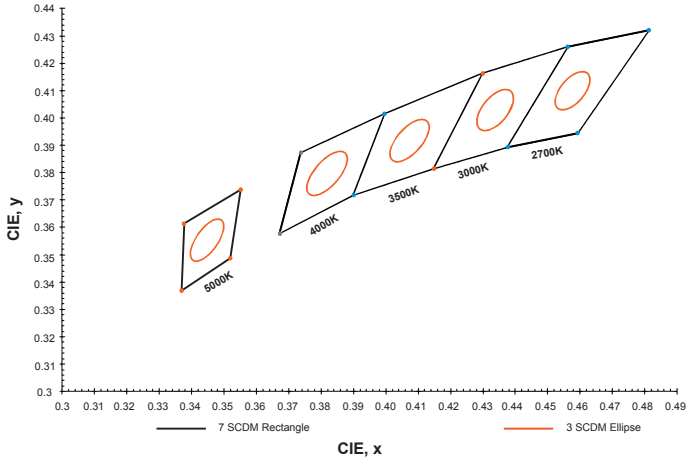

## Optical Spectrum

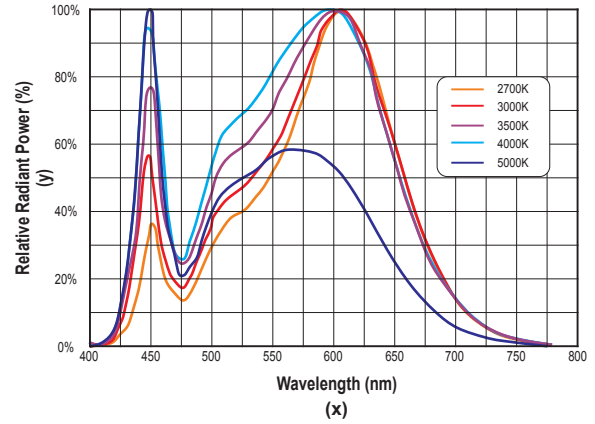

### NOTES:

- 1) The Color and Binning and Optical Spectrum charts are for reference only. For more detailed info, contact factory.
- 2) Reference Samsung Chromaticity Diagram for Color and Binning. Binning per ANSI C78.377-2015 @ 25°C; 3 SDCM.
- 3) The Optical Spectrum values vary depending on product type and color rank.
- 4) Driver not included.



# VR44-MU-xxx-8yy-xxxxA

## Packaging

Components individually packaged

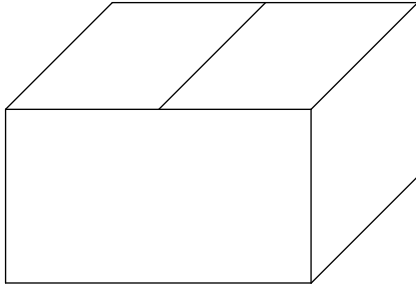

### LED HARNESS

TLC-HN02  
TLC-HN04

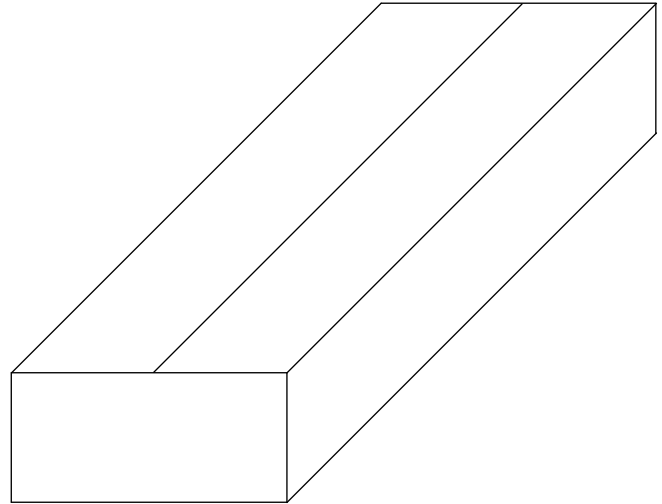

### LED LINEARHO MODULE

TMU240095CL8yyA

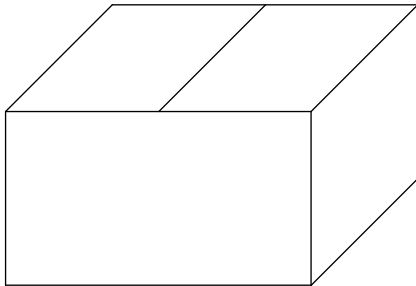

### LABELS

LABEL #1  
LABEL #2

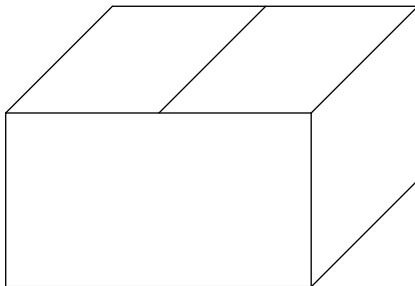

### HARDWARE

HHILPF00049

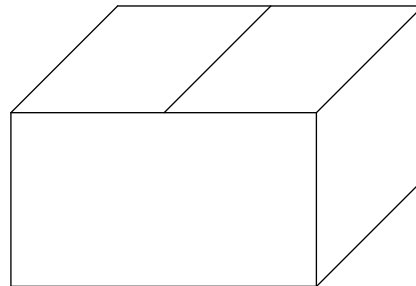

### LED DRIVER

T1M1UNV0700-30L  
T1M1UNV105P-40E  
T1M1UNV1400-60L  
T1M1UNV2100-88L  
T1M1UNV240P-96L

# VR44-MU-xxx-8yy-xxxxA

## Guidelines

(Reference instruction sheets for detail installation of VR kit)

## Termination Notes

- Connector Type: WAGO #744-392 (2 pin push wire connector)
  - AWG: 20...16 solid wire
  - Strip length: 8...9mm / 0.31...0.35in

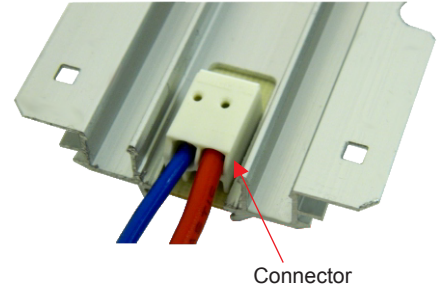

## Fastening Notes

- If fastening by screw hole, use any screw with diameter less than 0.185 in (4.7mm). Use all available screw holes to ensure good contact between back side of module and mounting surface. Refer to max specified torque for installation. Suggested screw sizes: #6 or M4 Pan Head screw.
- If fastening using double-sided tape, start with clean, oil-free and dust-free surface. Peel backing and place LED module on mounting surface. Firmly press down on the module to ensure good adherence. Follow the double-side tape manufacturer's installation instructions.
- BJB P2F (Push-to-Fix) fixing elements for PCBs can be used to fasten LED modules to mounting surface. Reference BJB's website for ordering information and specific model to use: <http://www.bjb.com/index.php?pid=376706&lid=10>.

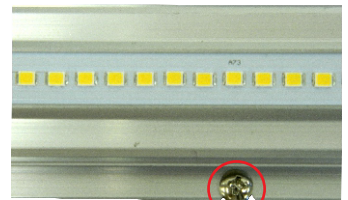

## Environmental Rating / Conformal Coating

- The DC LinearHO Modules have been evaluated for use in dry or damp locations only. If used in wet locations, acceptability and the need for additional evaluation shall be determined in the end product.
- Fulham's LinearHO modules are available with conformal coating; made to order with MOQ and lead time will apply. The conformal coating is a silicone based material which is double sprayed on the module only (LEDs and PCB). Conformal coating is recommended for the following applications: near ocean where salt is present, constant moisture, refrigeration, continuously high humidity, or outdoor applications. An IP rating of IP64 or IP65 is achieved when the conformal coating is used, but other factors should be considered. Fulham still recommends the luminaire also meet an IP64/65 rating.

## Electrostatic Sensitive Product (ESD)

- Fulham LED products should be handled with proper measures to protect against any potential ESD damage.
- When servicing, personnel should be ground and direct contact with LED should be avoided.

## Thermal Management

- Proper thermal management should be employed to ensure life and reliability of product. Max Tc of module should not be exceeded.
- Use of thermal grease, paste, pad, or other material interface is highly recommended.

## Polarity Notes

- DC Modules are polarity sensitive.
- Ensure that "positive" from LED Driver is connected to "positive" of LED modules and that "negative" from LED Driver is connected to "negative" of LED modules.
- Polarities of modules are marked with "+" for positive and "-" for negative.